

Hardware User's Guide

6" QuickPanel View

Intermediate, color STN & monochrome, flat bezel

IC754VGI06STD

IC754VHI06STD

IC754VGI06MTD

IC754VHI06MTD

January 2007
GFK-2326A



All rights reserved. No part of this publication may be reproduced in any form or by any electronic or mechanical means, including photocopying and recording, without permission in writing from GE Fanuc Automation.

Disclaimer of Warranties and Liability

The information contained in this manual is believed to be accurate and reliable. However, GE Fanuc Automation assumes no responsibilities for any errors, omissions or inaccuracies whatsoever. Without limiting the forgoing, GE Fanuc Automation disclaims any and all warranties, expressed or implied, including the warranty of merchantability and fitness for a particular purpose, with respect to the information contained in this manual and the equipment or software described herein. The entire risk as to the quality and performance of such information, equipment and software, is upon the buyer or user. GE Fanuc Automation shall not be liable for any damages, including special or consequential damages, arising out of the use of such information, equipment and software, even if GE Fanuc Automation has been advised in advance of the possibility of such damages. The use of the information contained in the manual and the software described herein is subject to GE Fanuc Automation's standard license agreement, which must be executed by the buyer or user before the use of such information, equipment or software.

Notices

GE Fanuc Automation reserves the right to make improvements to the products described in this publication at any time and without notice.

© 2007 GE Fanuc Automation. All rights reserved. QuickPanel View is a trademark of GE Fanuc Automation, in the United States and other countries. Any other trademarks referenced herein are the property of their respective owners and used solely for purposes of identifying compatibility with the products of GE Fanuc Automation.

The 6" QuickPanel View has been tested and found to meet or exceed the requirements of U.S. (47 CFR 15), Canadian (ICES-003), Australian (AS/NZS 3548) and European (EN55022) regulations for Class A digital devices when installed in accordance with guidelines noted in this manual.

Microsoft[®] requires the following notes be published according to their additional licensing provisions:

Users are advised that a maximum of ten (10) computers or other electronic devices may simultaneously connect to, access and use services of the Microsoft Windows[®] CE Operating system on the QuickPanel View solely for remote access (including connection sharing) The ten connection maximum includes any indirect connections made through 'multiplexing', or other software or hardware which pools or aggregates connections.

Note that the QuickPanel View does not provide any server functionality utilizing Remote Desktop Protocol (RDP) to remotely connected client computers or devices. However, it does support connectivity to a remote Microsoft[®] Terminal Services server. The server providing these services must meet these restrictions and other Microsoft licensing requirements as applicable.

Notice Regarding Video Standards

This product is licensed under one or more video patent portfolio licenses such as and without limitation VC-1 and MPEG4 Part 2 Visual for the personal and non-commercial use of a

consumer to:

(i) Encode video in compliance with the standards licensed under such patent portfolio licenses and/or

(ii) Decode video that was encoded by a consumer engaged in a personal and non-commercial activity and/or was obtained from a video provider licensed to provide video under such patent portfolio licenses.

Such license extends to this product only and only to the extent of other notices which may be included in this document. The license does not extend to any other product regardless of whether such product is included with this licensed product in a single article. No license is granted or shall be implied for any other use. Additional information may be obtained from MPEG LA, L.L.C. See <http://www.mpegla.com>.

The FCC requires the following note to be published according to FCC guidelines:

This equipment has been tested and found to comply with the limits for a Class A digital device, pursuant to Part 15 of the FCC Rules. These limits are designed to provide reasonable protection against harmful interference when the equipment is operated in a commercial environment. This equipment generates, uses, and can radiate radio frequency energy and, if not installed and used in accordance with the instruction manual, may cause harmful interference to radio communications. Operation of this equipment in a residential area is likely to cause harmful interference in which case the user will be required to correct the interference at his own expense.

Any changes or modifications to the product or installation that are not expressly approved by GE Fanuc Automation could void the user's authority to operate the equipment under FCC rules.

Industry Canada requires the following note to be published:

This Class A digital apparatus complies with Canadian ICES-003.

The following statements are required to appear for Class I Div 2 Hazardous Locations.

1. WARNING - EXPLOSION HAZARD - SUBSTITUTION OF COMPONENTS MAY IMPAIR SUITABILITY FOR CLASS 1, DIV. 2.

2. WARNING - EXPLOSION HAZARD - WHEN IN HAZARDOUS LOCATIONS, TURN OFF POWER BEFORE REPLACING OR WIRING MODULES.

3. WARNING - EXPLOSION HAZARD - DO NOT CONNECT OR DISCONNECT EQUIPMENT UNLESS POWER HAS BEEN SWITCHED OFF OR AREA IS KNOWN TO BE NON-HAZARDOUS.

Power, input and output (I/O) wiring must be in accordance with Class 1, Division 2 wiring methods, Article 501 4(b) of the National Electric Code, NFPA 70 and in accordance with the authority having jurisdiction.

For a complete list of agency qualifications, please refer to Appendix A1.

We want to hear from you. If you have any comments, questions, or suggestions about our documentation, send them to the following email address: doc@gefanuc.com.

Contents

1	Welcome	1
	Getting Started	2
	Basic Setup	2
	Unit Runtime Setup	3
	Startup	3
	Shutdown	4
	Panel Cutout	4
	Technical Support	8
2	Overview	9
	QuickPanel View Hardware	10
	Layout Diagram	10
	Block Diagram	12
	QuickPanel View Software	13
	Windows CE.NET	13
	Working with Windows CE	13
	Pocket Internet Explorer	14
	Backup	16
	Reboot	17
	Storage Manager	18
	System Information	18
	Copy Project to Flash Card	18
	Emulate PPC	19
	HTTP File Transfer Utility	19
	FTP Server	21
3	Detailed Operation	25
	Touch Screen Display	26
	Touch Screen	28
	Keyboard	31
	Soft Input Panel	31
	Communication Port	36
	COM1- Serial	36
	Recommended Cabling for TIA/EIA422 or TIA/EIA485	36
	Working with the COM port	38
	CF Port	42

Ethernet	43
Expansion Bus	47
DIP Switches	48
Memory	50
Flash Memory	50
SRAM Memory	51
DRAM Memory	51
Boot Loader ROM	52
Memory Expansion Slot	52
Other Subsystems	54
Power Management	54
Battery Backup	54
Real-time Clock	55
Configuring SNTP	56
A1 Design Specifications	59
Physical	59
DC Power	59
Display	60
Front Panel	60
Touch Screen	61
CPU	61
Memory	61
Memory Expansion Slot	61
Expansion Ports	62
Communication Port	62
Environmental	62
Battery	63
Calendar/Clock	63
Agency Qualifications	63
A2 Troubleshooting	65
Power up	65
Pocket Internet Explorer	65
Physical Unit	65
Index	67

Congratulations on your purchase of a QuickPanel View, the most advanced compact HMI available. The QuickPanel View is available in different configurations to suit your requirements. Equally at home in a networked environment or as a stand-alone unit, the QuickPanel View is the ideal solution for factory floor HMI.

Powered by Microsoft Windows CE.NET™, today's embedded operating system of choice, the QuickPanel View provides a fast track for application program development. The commonality with other versions of Windows simplifies porting your existing program code. Another benefit of Windows CE is the familiarity of the user interface, shortening the learning curve for operators and developers alike. The availability of third-party application software makes this operating system even more attractive.

The 6" QuickPanel View is an all-in-one microcomputer designed for maximum flexibility. The design, based on an advanced Intel® microprocessor, brings together a high-resolution operator interface with a variety of I/O options. With many standard ports and expansion busses from which to choose, you can connect to most industrial equipment.

The QuickPanel View is equipped with several memory types to satisfy even the most demanding applications. A 32 MB section of DRAM is split between the operating system, an object store, and application memory. A 32 MB section of non-volatile FLASH memory, functioning as a virtual hard drive, is divided between the operating system and persistent storage for application programs. The retentive memory consists of 512 KB of battery-backed SRAM for data storage, ensuring your valuable data will never be lost, even during a power failure.

The many features of the QuickPanel View make it an obvious choice for a world of applications. Your smart choice will provide reliable operation for years to come.

GETTING STARTED

Basic Setup

Your 6" QuickPanel View is shipped ready for use after a few configuration steps. To power up all you need to do is connect a DC power supply via the supplied quick-connect plug. Depending on your application, you may also want to connect and configure optional input devices (see page 31), communications ports (see page 36) and expansion adapters (see page 47).



Caution - Electrical Shock Hazard: To avoid personal injury or damage to equipment, ensure that the DC supply is disconnected from power and that the leads are not energized before attaching them to the unit's power supply plug.

To connect a DC power supply

1. Using the three screw terminals shown in the following diagram, attach a 24VDC, 24W power supply to the plug supplied with the QuickPanel View. See the **DC Power** section starting on page 59 for power supply and conductor specifications.
2. Insert the plug into the power supply socket and securely tighten the attaching screws.

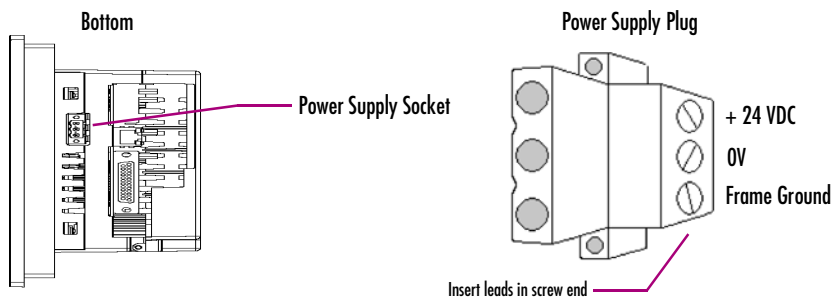

Note: The torque range for the attaching screws is 4-6 inch/lbs.

Unit Runtime Setup

To download an application to a QuickPanel View, you must set up a data link between it and your development workstation. For more information, see “Ethernet” (page 36) and look up “Downloading a Machine Edition Project” in Proficy Machine Edition online help.

Startup







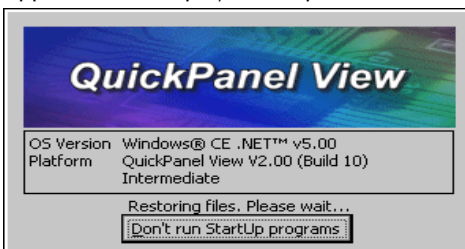

When you first start up the QuickPanel View, a few configuration steps are necessary.

To start the QuickPanel View

1. Apply AC power to the 24VDC supply.

Once power is applied, the QuickPanel View begins initializing. The first thing to appear on the display is the splash screen.



2. To skip running any programs included in the StartUp folder, tap **Don't run StartUp programs**. The splash screen disappears automatically after about 5 seconds. The Windows CE desktop then becomes visible.
3. Tap  **Start**, point to  **Settings**, then tap  **Control Panel**.
4. In the Control Panel, double-tap  **Display** to configure the LCD display (see page 26).
5. In the Control Panel, double-tap  **Stylus** to configure the touch screen (see page 28).
6. In the Control Panel, double-tap  **Date and Time** to configure the system clock (see page 55).
7. In the Control Panel, double-tap  **System** to configure a network machine name (see page 45). Many applications, including Proficy Historian, require a unique machine name. It is recommended procedure to set a unique network name for the QuickPanel View to avoid future conflicts.
8. In the Control Panel, double-tap  **Network and Dial-up Connections** to configure network settings (see page 44).

9. On the desktop, double-tap  **Backup** to save any new settings through a power cycle (see page 16).

Shutdown

There are no specific dangers associated with a power failure or other unplanned shutdown of the QuickPanel View. In general, programs are retained in FLASH memory and user data can be retained in battery-backed SRAM. However, some operating system settings are retained only with user intervention (noted throughout this manual), so in order to carry out a graceful shutdown of the QuickPanel View, we recommend you perform the following procedure.

To shut down the QuickPanel View

1. Quit any programs that are running and wait for all file operations to complete.
2. To save changes to operating system settings (e.g., contrast or touch screen sensitivity), run Backup (see page 16).
3. Run Reboot (see page 17). When the Windows CE desktop reappears, remove AC power from the 24VDC supply.

Panel Cutout

For convenience and versatility, this version of the QuickPanel View can be mounted in cutouts of two different specifications. Refer to the appropriate section that follows.

Small Cutout Dimensions.

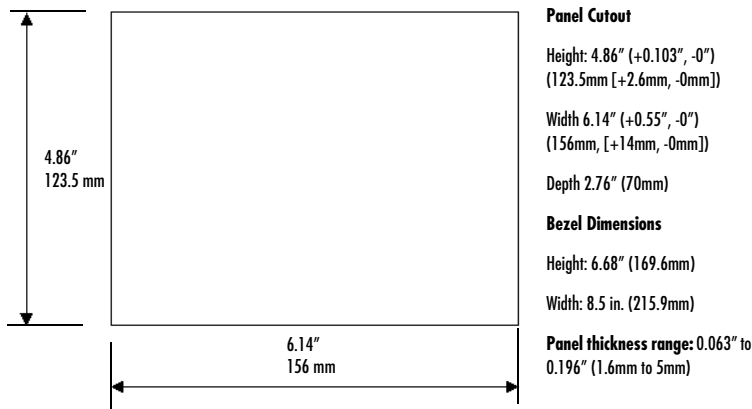

The unit will **not** fit through the small cutout with a CF card inserted in the port, with any cables connected, or with the power supply plug inserted in the socket.

To secure the QuickPanel View to a panel with the small cutout, use the four included mounting clips, which hook into the openings located on the top and bottom of the housing as shown in the following illustration.

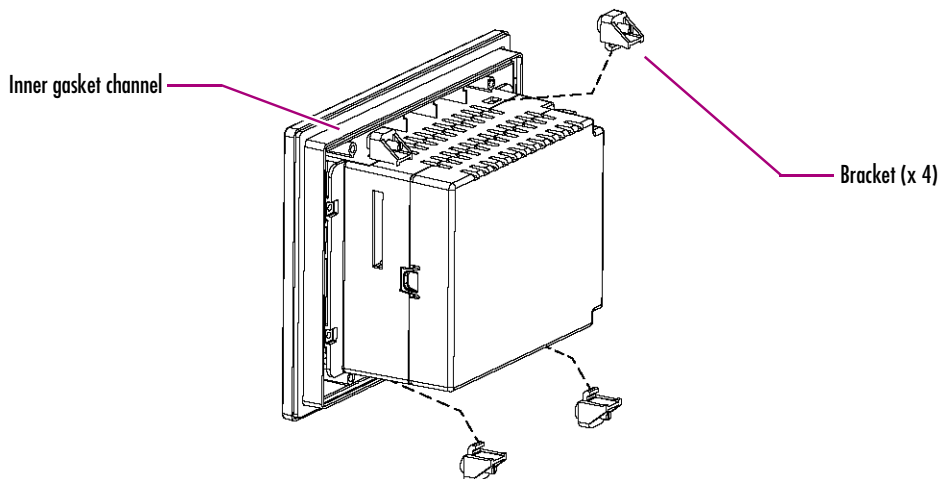

To mount the unit in a panel with small cutout dimensions

1. Separate the small cutout gasket from the supplied gasket sheet (the small cutout gasket is nested within the larger one, and has two notches on each long side). Avoiding damage to the gasket, carefully remove the covering over its adhesive backing, and then apply the gasket with its adhesive surface toward the inner gasket channel (see the illustration above).
2. Verify that the gasket is properly seated in the gasket channel, then insert the unit into the panel cutout (without a CF card in the CF port).
3. Insert the hook of each mounting bracket in the housing openings.
4. Tighten the screws to 2.6-4.4 inch/lbs (0.3-0.5 Nm).

Large Cutout Dimensions

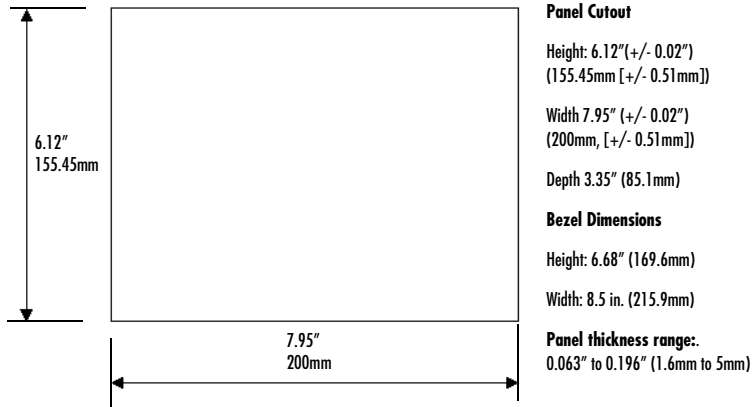

To secure the QuickPanel View to a panel with the large cutout, use the four included mounting clips, which hook into the openings located on the top and bottom of the housing, as well as the four included clip extensions, which slide over the inner portion of the bezel as shown in the following illustration.

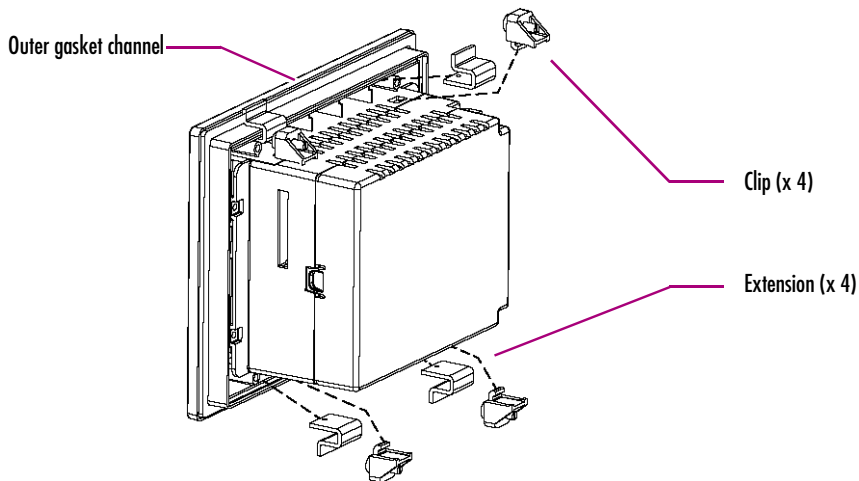

To mount the unit in a panel with large cutout dimensions

1. Separate the large cutout gasket from the supplied gasket sheet (the large cutout gasket surrounds the outside of the sheet). Avoiding damage to the gasket, carefully remove the covering over its adhesive backing, and then apply the gasket with its adhesive surface toward the outer gasket channel (see the illustration above).
2. Verify that the gasket is properly seated in the gasket channel, then insert the unit into the panel cutout (without a CF card in the CF port, to avoid damage to the card).
3. Slide the clip extensions over the inner portion of the bezel, at the location of the mounting clip holes in the housing.
4. Insert the hook of each mounting clip in the housing openings.
5. Tighten the screws to 2.6-4.4 inch/lbs (0.3-0.5 Nm).

The mounting clips hold the unit in place by tension alone. No drilling is required.

Notes:

- For compliance to NEMA 4, 4x, and 12 qualification, the unit must be mounted in a comparably NEMA rated (IP56 equivalent) panel or enclosure.
- For compliance to ATEX agency qualification, the unit must be mounted in an IP66 panel or enclosure.
- To avoid gasket degradation, limit repeated insertions or removals of the unit and retightening of the mounting clips. For full protection, always use a fresh gasket. Replacement gaskets may be ordered using part number IC754ACC06GASE.
- For adequate ventilation, allow at least 3 inches of space between adjacent equipment and all sides of the QuickPanel. Ensure that specified conditions of temperature and humidity are not exceeded.

In outdoor applications, direct sun exposure may impose increased thermal loads on the QuickPanel leading to excessive temperature rises. Cabinet design and orientation must be carefully considered to avoid exceeding the operational temperature limits. These considerations could include shading for the QuickPanel and its cabinet with awnings or other solar opaque materials, avoiding a due East or West facing of the cabinet, ventilation or active cooling of the cabinet, or other methods.

TECHNICAL SUPPORT

If you are located in North America and have technical problems that cannot be resolved with the information in this guide, please contact us by telephone, fax, or email; or visit one of the links on our website:

Telephone: 1-800-GE-FANUC (1-800-433-2682)

Fax: (780) 420-2049

Email: support@gefanuc.com

In South America:

Telephone: +58 (261) 760-2862

Fax: +58 (261) 765-0909

Email: support@gefanuc.com

In Europe, the Middle East, and Africa:

Telephone: +800 1-GE-FANUC (+1 780-401-7717)

Email: support.emea@gefanuc.com

In Asia Pacific:

Telephone: +86-400-820-8208

Email: support.cn@gefanuc.com (China customers)

support.jp@gefanuc.com (Japan customers)

support.in@gefanuc.com (India and remaining Asia customers)

Web: <http://globalcare.gefanuc.com> (to locate the Technical Advisor page and a listing of supported devices (CF cards, etc.) click on the Operator Interface Product Family link or choose QuickPanel View from the Product list).

Comments about our manuals or help: doc@gefanuc.com

2

Overview

This chapter provides introductory information on the 6" QuickPanel View hardware and software with descriptive procedures for completing some of the most common tasks you will encounter.

In this chapter:

QUICKPANEL VIEW HARDWARE	10
Layout Diagram	10
Block Diagram	12
QUICKPANEL VIEW SOFTWARE	13
Windows CE.NET	13
Working with Windows CE	13
To place a program in the Start menu	14
Pocket Internet Explorer	14
To configure a dial-up connection	14
To configure a Proxy server	15
Backup	16
To run the Backup program	16
Reboot	17
To reboot the system	17
Storage Manager	18
System Information	18
To run the System Information program	18
Copy Project to Flash Card	18
To copy a Machine Edition project onto a CF card	19
To update a Machine Edition project	19
Emulate PPC	19
To use Emulate PPC during an ActiveSync session	19
HTTP File Transfer Utility	19
To use the HTTP utility	20
FTP Server	21
To install a certificate	23

QUICKPANEL VIEW HARDWARE

Layout Diagram

In addition to the primary touch screen interface, the 6" QuickPanel View supports a variety of communication ports including an expansion bus to allow great flexibility in application. The back of the QuickPanel opens allowing access to the expansion bus connector, memory expansion connector, DIP switches and battery. The following diagram shows the physical layout of the QuickPanel View and the locations of ports and connections.



Caution: Remove power from the QuickPanel View before opening the back. Working on a “live” unit may result in damage to equipment and injury to personnel. Always use anti-static precautions (i.e. grounded wrist strap) when accessing the interior of the unit. Do not allow conductive material, liquid or solid, to contact the electronics of the QuickPanel.

The left LED below the display is green when power is applied and amber if the backlight fails;¹ the right LED is tricolor (green, red, or amber) and programmable.

¹ Backlight is not field replaceable.

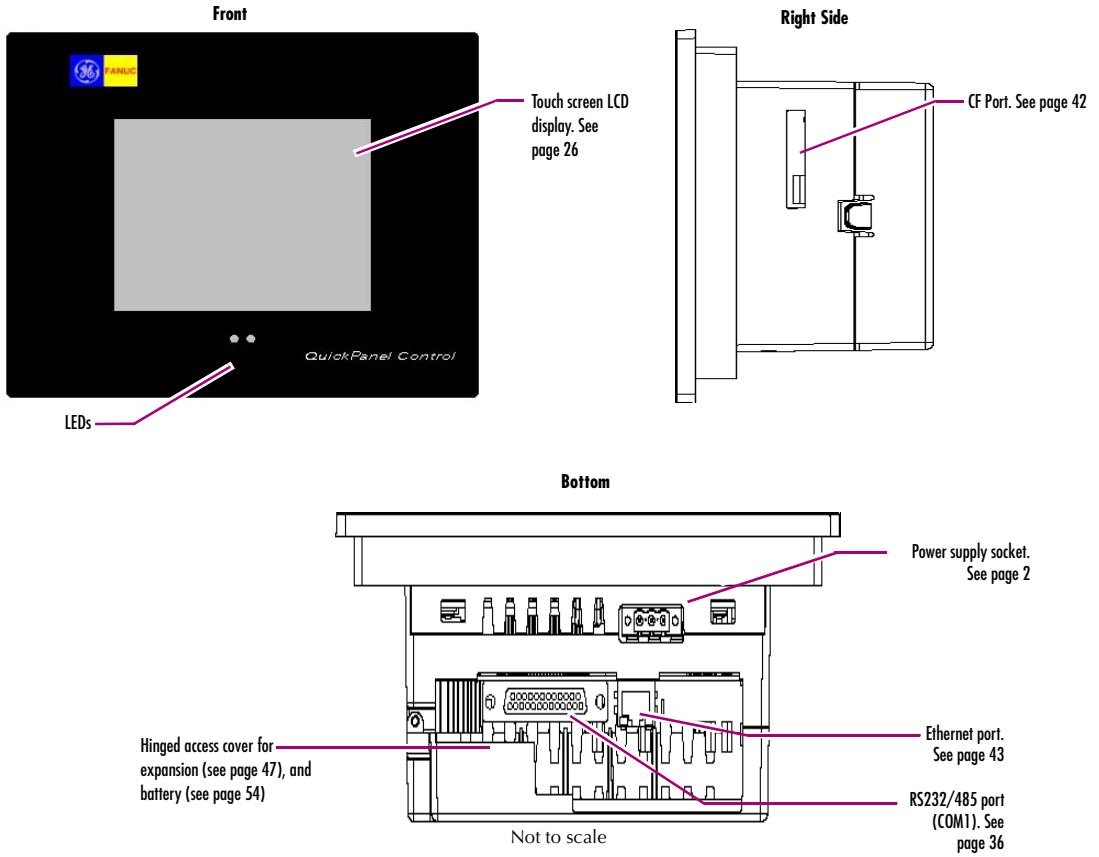

Block Diagram

The 6" QuickPanel View is based on the Intel® XScale™ PXA255 microprocessor, and employs large-scale integration to provide high performance with a small footprint. The following block diagram illustrates the major functional areas of the QuickPanel View and the interfaces between them.

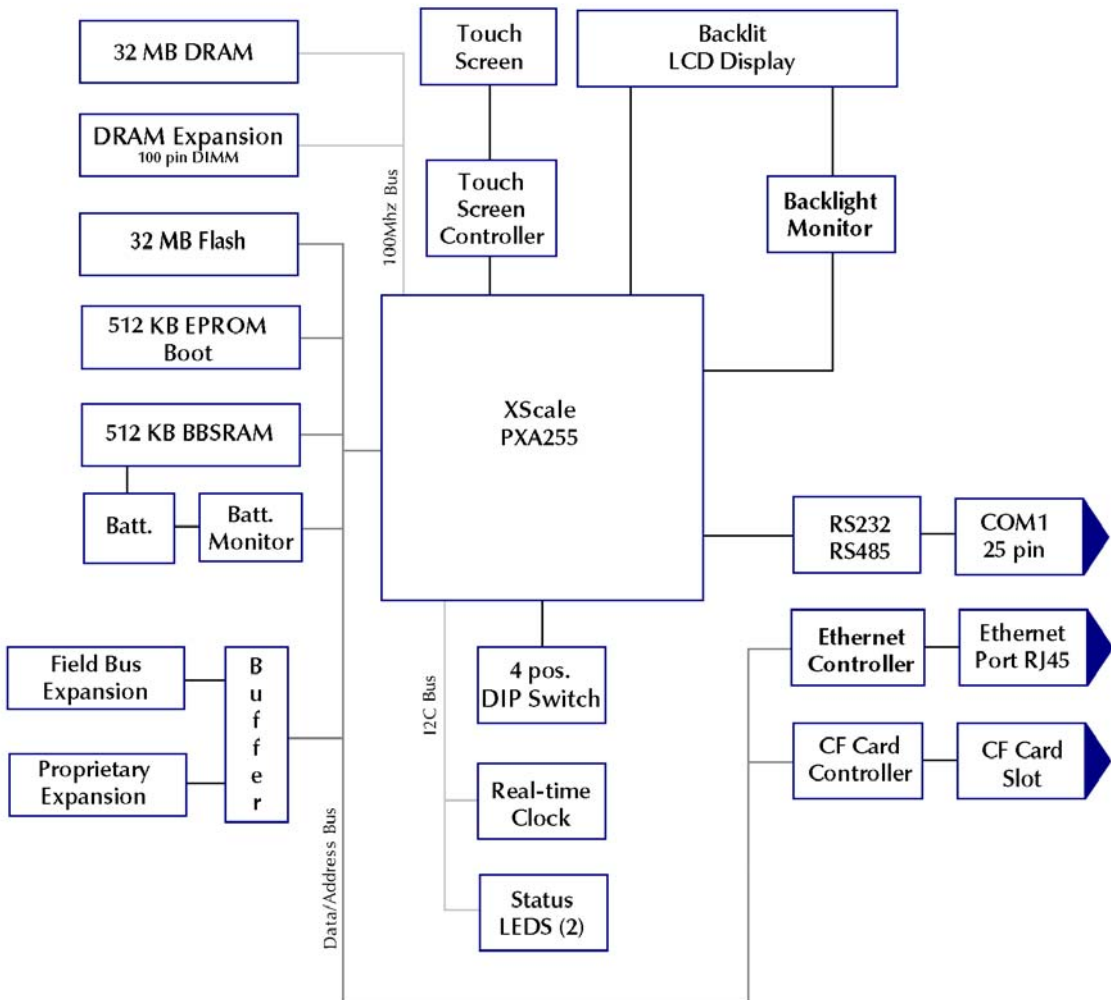

QUICKPANEL VIEW SOFTWARE

Windows CE.NET

Microsoft Windows CE.NET is the operating system for the QuickPanel View. It is a full 32-bit O/S with a graphical user interface. This operating system is finding widespread application in hand-held PCs and embedded HMI's, such as the QuickPanel View. From a user's perspective, the familiar look and feel of the Windows CE environment shortens the learning curve for those having experience with Windows 95/98/NT/2000/ME/XP. From the software developer's perspective, the CE environment is a subset of the WIN32 application programming interface, simplifying the porting of existing software from other versions of Windows.

The QuickPanel View operating system is stored in a 16 MB block of FLASH memory and copied to DRAM for execution. The operating system starts automatically following a power-up or reset of the QuickPanel View.

For more on Windows CE visit



www.microsoft.com/windows/embedded/windowsce/default.msp.

Working with Windows CE

Although the main user input device when working with Windows CE is the touch screen, it can often be convenient to use keyboard shortcuts, such as those described in the following table.

Keyboard Shortcut	Action
CTRL+ESC or 	Opens the Windows CE Start menu. Use arrow keys to select a program and ENTER to run it.
ALT+TAB	Starts the Task Manager. Use it to quit unresponsive programs.
CTRL+ALT+=	Starts the touch screen calibration.
SPACEBAR	Equivalent to single-tap.
ENTER	Equivalent to double-tap. In a dialog box, equivalent to OK .
TAB	In a dialog box, select next control.
SHIFT+TAB	In a dialog box, select previous control.
CTRL+TAB	In a tabbed dialog box, open the next tab.
ESC	Close dialog box, discarding changes.
ARROW KEYS	In a dialog box, select controls or items from a list .

To place a program in the Start menu

1. Start  Windows Explorer.
2. Navigate to the program you want to place in the  Start menu.
3. Tap the program's icon to select it.
4. From the **Edit** menu, choose **Copy**.
5. Navigate to the `\Windows\Programs\` folder.
6. From the **Edit** menu, choose **Paste Shortcut**.
7. To save the settings, run  **Backup** (see page 16).

Pocket Internet Explorer

Microsoft's Pocket Internet Explorer is a full featured browser that is fully integrated with the Windows CE operating system. This browser allows you to connect with an internet service provider, view Web pages and download from FTP sites.

Pocket Internet Explorer supports JScript. Java support can be added from third-party sources. Pocket Internet Explorer does not support VBScript; however, VBScript components are included in the operating system and may be used by third-party applications such as Proficy Machine Edition.

A connection can be established over an Ethernet network or a dial-up connection (default). The Ethernet or dial-up connection must be properly configured.

To configure a dial-up connection

1. Start  Pocket Internet Explorer.
2. From the **Tools** menu, choose **Options**.

The **Internet Options** dialog box appears.

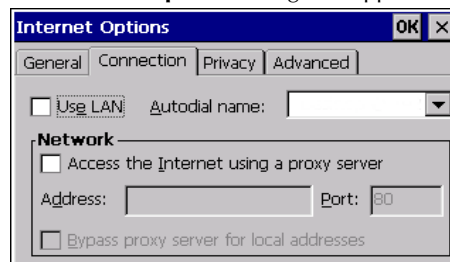



3. On the **Connection** tab, select the dial up connection from the combo list.
4. Tap **OK**.
5. To save the settings, run  **Backup** (see page 16).

To configure a LAN connection

1. Start  Pocket Internet Explorer.
2. From the **Tools** menu, choose **Options**.

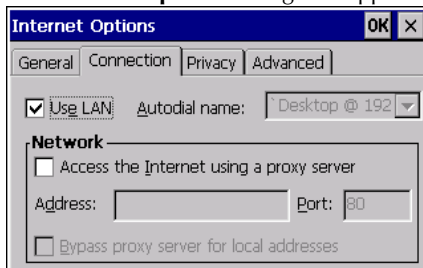
The **Internet Options** dialog box appears.





3. On the **Connection** tab, select the **Use LAN** check box.
4. Tap **OK**.
5. To save the settings, run  **Backup** (see page 16).

To configure a Proxy server

1. Start  Pocket Internet Explorer.
2. From the **Tools** menu, choose **Options**.

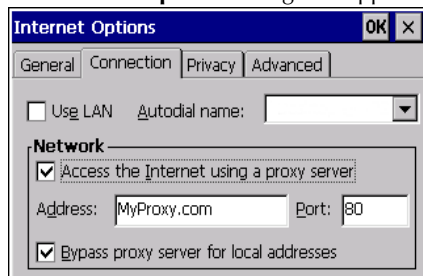
The **Internet Options** dialog box appears.



3. On the **Connection** tab, select the **Access the Internet using a proxy server** check box.
4. In the **Address** box, type the URL of your proxy server (see your ISP or network administrator).
5. In the **Port** box, type the server's port number for HTTP access.
6. Select the **Bypass Proxy for Local Addresses** check box to connect directly to sites in your intranet.
7. Tap **OK**.
8. To save the settings, run  **Backup** (see page 16).

Overview

QuickPanel View Software

Backup

Backup saves changes that you make to the Windows Registry or Desktop to Flash memory. This utility is required because the QuickPanel View is not battery powered. Specifically, Backup does the following:

- It stores the Windows CE registry (including any control panel settings) in Flash memory.
- It stores any changes (or additions) made to the 'Windows' subtree of the file system in the user block of FLASH memory.

Run Backup whenever you make configuration changes to the operating system or installed applications, and prior to shutting down the QuickPanel View.

To run the Backup program

1. On the desktop, double-tap  **Backup**.

The **Backup** dialog box appears.

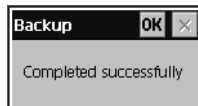





2. Tap **OK**.

Reboot

Reboot performs a controlled and orderly shut down of the Windows CE operating system, then restarts the QuickPanel View. This ensures all open files are closed properly.

To reboot the system

1. To save changes to system configurations, run  **Backup** (see page 16).
2. Tap  **Start**, point to  **Programs**, then the  **System** folder, and tap  **Reboot**

A confirmation dialog box appears.

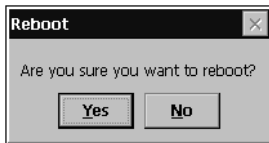

3. Tap **Yes**.
The operating system reboots.

Storage Manager

Use Storage Manager to repair or format lost or corrupted data volumes. Storage Manager can repair data volumes existing either in Compact Flash (CF) or battery-backed SRAM (BBSRAM). Data volumes existing in the main flash file system of the QuickPanel View may not be repaired by Storage Manager.

Storage Manager, accessed from the Control Panels folder, is a Microsoft product for which on-line help is available.

System Information

System Information is a custom utility that displays a splash screen with the following information:

- **Operating System version.** For example, 'Windows CE 5.00'.
- **Platform.** Identifies the host hardware, its version and build number.

Tapping **More Info** on the splash screen opens the Advanced System Information window, which provides information such as hardware version and serial number, CPU type and specifications, etc. This information can be especially useful if you are contacting GE Fanuc Support.

To run the System Information program

1. On the desktop, double-tap  **System Information**.

The **System Information** splash screen appears.

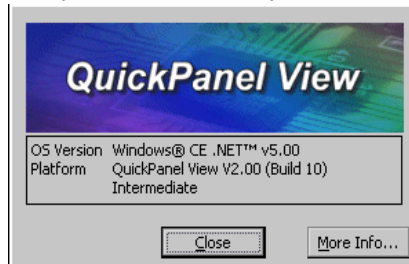

2. Tap **More Info** to open the Advanced System Information window, or tap **Close** to continue.

Network information alone can be viewed by double-tapping the  **LAN** icon displayed on the taskbar for each connection.

Copy Project to Flash Card

RestorePCCard is a custom utility for transferring Proficy™ Machine Edition™ Projects between compatible QuickPanel View units via CF cards.

To copy a Machine Edition project onto a CF card

1. Ensure there is a blank CF card in the in the CF port.
2. Double tap the  **Copy Project to Flash Card** icon on the desktop.
3. Tap **Yes** when the **Proceed with Copy to CF Card** confirmation dialog box appears.

The system copies the project onto the blank CF Card.

To update a Machine Edition project

You can update a Machine Edition project currently stored on the QuickPanel View with a revision stored on a CF Card.

1. Insert the CF Card containing an upgraded version of the Machine Edition project in the CF port.
2. Reboot the machine (see page 17).

The QuickPanel View automatically loads the new project from the CF Card, overwriting the old project on the machine.

3. Remove the CF Card from the slot.

Emulate PPC

Emulate PPC is a utility that allows the QuickPanel to emulate a Pocket PC 2003 platform during an ActiveSync session, enabling the download of third-party Pocket PC 2003 software.

To use Emulate PPC during an ActiveSync session

1. Start  **Windows Explorer** , double tap  **Windows**, then double tap  **EmulPPC**.

The Emulate PPC dialog box appears.

2. Start the ActiveSync session. When installation of third-party software is complete, close the dialog box to deactivate Emulate PPC.

HTTP File Transfer Utility

The HTTP File Transfer Utility (HFTU) is a small, standalone command line program that allows you to send and delete files to and from computers over a network. The HFTU uses the HTTP protocol, so you can even send files to computers over the Internet.

Run the HTTP utility from a command line prompt, from a batch file (.BAT) or as an application call in a script. The HTTP utility is an executable (.EXE) file included in the 6" QuickPanel View's operating system.

The HTTP utility currently supports two file transfer commands: COPY and DELETE.

Note: In order to function, the HTTP File Transfer utility requires both computers to have web servers that support PUT functionality. (Most web servers support PUT, including the Proficy Machine Edition web server installed with the runtimes for View and Logic Developer - PC.) If in doubt, check the documentation for your web server.

To use the HTTP utility

1. From Programs in the  Start menu, choose  Programs, then choose  **Command Prompt**.

The **Command Line** editor appears.

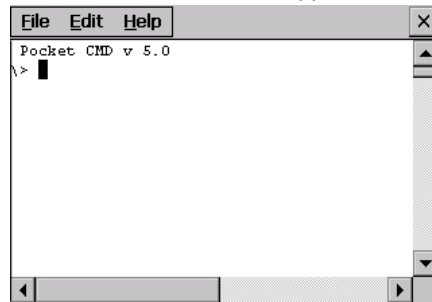

2. Type commands as required.
3. Use the following syntax:

HTTPUTIL COPY source destination

Where “source” is the URL of the source file, and “destination” is the URL of the destination file. For example:

```
HTTPUTIL COPY \MyFile.txt http://MyServer/webfiles/MyFileBACKUP.txt
```

Copies a file called MyFile.txt on drive C: of the local computer to the webfiles folder under the web server at //MyServer. Note that you can rename a file as you copy it.

HTTPUTIL DELETE url

Where “url” is the remote URL of the file you want to delete. This URL must use the “//” or “HTTP://” syntax. For example:

```
HTTPUTIL DELETE http://MyServer/webfiles/MyFileBACKUP.txt
```

Deletes a file called MyFileBACKUP.txt from the webfiles directory under the web server at HTTP://MyServer.

FTP Server

The FTP Server included with the QuickPanel View supports both standard (RFC 959) and Explicit FTPS (i.e., FTP/SSL, Auth TLS, TLS-C, RFC-4217). It does not support SFTP or implicit FTPS, which uses different ports and is based on SSH rather than SSL.

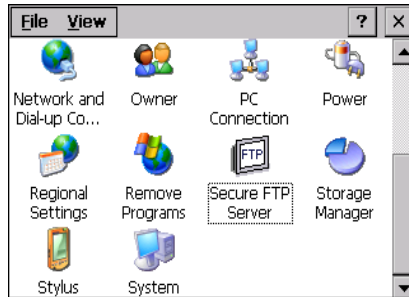

All configuration of the FTP server is accomplished with the Secure FTP Server control panel applet. By default, the server is not enabled. Once enabled, a background program will run, waiting for clients to connect. Up to ten connections are supported. Sessions that are idle for five minutes are terminated by the server.

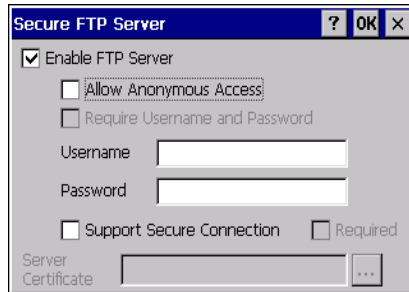

The Server supports:

- Non-secure operation. All information including username, password, and data is transmitted with no encryption and susceptible to packet sniffing and various FTP attacks. This is the default.
- Both secure and non-secure operation. This mode of operation, either secure or non-secure, is determined by the client when it connects. This operation is active when 'Support Secure Connection' is enabled, but 'Required' is not.

- Secure operation only. Secure operation uses encrypted connections for the control connection. The data connections are encrypted or non-encrypted based on the settings of the client. Secure operations also require the server to have a signed server certificate it can use to prove it is the actual machine the client wanted to reach and not an imposter. This mode is active when both 'Support Secure Connection' and 'Required' are enabled.

By default, the server requires a username/password combination to be configured. The server supports one username/password combination to authenticate remote users. There are three modes of authentication operation:

- No support for anonymous login. This is the default.
- Anonymous with no password. This is enabled when 'Allow Anonymous Access' is checked, but 'Require Username and Password' is not checked.
- Anonymous with password requested (but not validated). This is enabled when 'Allow Anonymous Access' and 'Require Username and Password' are checked. This can prevent some types of attacks and is required by some clients.

Once connected, a remote user is logged into the FTP root directory. This is available from the QuickPanel View as `\Temp\ftp` and is a volatile RAM area. Files placed in this area are not persisted over a power cycle/reboot and use memory from the Storage Memory allocation. For this reason, remote users are only able to read, rename, and delete files from the FTP root directory. Programs running on the QuickPanel can access `\Temp\ftp` like any other directory, but remote users cannot fill up Storage Memory remotely.

All removable flash devices appear to remote FTP users as directories off of the FTP root directory. PC Flash cards partitions appear as directories such as `\PCFlashStorage`. The names contain no spaces as FTP commands do not support spaces in filenames. Full access privileges are granted for the client in these folders/devices.

Removable flash device directories are captured when a session is opened and are not changed while the session exists. If you start without a CF card installed, you will have to close your session and login again to see the CF directory. If the CF card existed when you logged in and is removed and inserted, it will still work provided the CF card's device name did not change during reinsertion.

A server certificate is a special type of document which contains information about the server's settings and a chain of electronic signatures to guarantee the document

has not been altered. A Server certificate must be chosen from the certificates available in the QuickPanel View Secure FTP Server control panel applet.

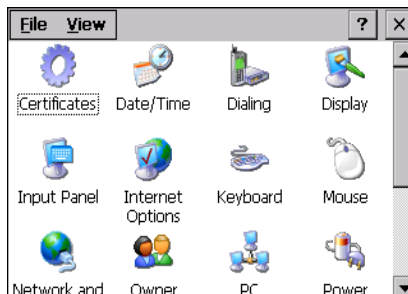

The certificate itself is imported with the Certificates control panel applet. The main requirements of the certificate are that it must have the server authentication key usage attribute set and the name of the certificate should match the name used to connect to the FTP server (which could be the IP address of the server).

Certificates can either be purchased from an online vendor and imported into the QuickPanel View, or a self-signed certificate can be generated from the QuickPanel View. The benefit of a purchased certificate is that any user that has the root certificate used by the online vendor can determine the certificate is valid without the need for any additional information. A self-signed certificate is only known to be valid by clients that have added the certificate to their trusted list. Users can still access a server using a self-signed certificate, but they lose the ability to verify that no one is operating as an imposter somewhere on the network between them and the server.

To create a self-signed certificate

1. Double click the `genslfcert.exe` utility in the QuickPanel View/Control.
2. From the command prompt, type "`genslfcert CN=<unique identifier>`".

You may specify a unique identifier of your choice, such as machine name, machine location, or IP address in place of unique identifier.

This will create a self-signed certificate in the My Certificates section of the certificates control panel and a `SelfSigned.cer` file in My Computer which can be transferred to FTP Clients as a trusted source. Certificates may be managed through snap-in's to the Microsoft® Management Console or other third party management consoles.

A Backup should be performed after configuring the FTP server and/or creating the self-signed certificate.

To install a certificate on an FTP Client

1. Double click the certificate. Select the **General Tab**.

The Certificate properties are displayed.

2. Click the **Install Certificate** button.

The Certificate Import Wizard appears.

3. Click **Next** to continue.

The Certificate Store screen appears.

4. Specify whether Windows should place the certificate in a certificate store or select another location. Click **Next** to continue.

The Completing the Certificate Import Wizard screen appears.

5. Click **Finish** to complete the installation of the certificate.

The Security Warning message appears. This message informs you Windows will automatically trust any certificate issued by this Certification Authority.

6. Click **Yes** to allow Windows to trust any certificate issued by this Certification Authority.

3

Detailed Operation

Touch Screen Display	26
To adjust the display contrast	26
To set backlight for auto turn off	27
To calibrate the touch screen	28
To set the double-tap sensitivity	29
Keyboard	31
To show/hide the Soft Input Panel	31
To display the Soft Input Panel icon in the system tray	31
To change key configurations	34
To reset SIP location	34
Communication Port	36
To add a new remote networking serial connection	38
To add a virtual private network or PPP over Ethernet	39
To change the default device properties	40
To change the default TCP/IP settings	41
CF Port	42
Ethernet	43
To set an IP address	44
To set up access to a Windows network	45
To access a remote resource on a Windows network	46
Expansion Bus	47
DIP Switches	48
To configure startup behavior with DIP switch 2	48
Memory	50
To add External Flash memory with a CF Card	50
To change the DRAM memory allocation	51
To install additional DRAM	53
Other Subsystems	54
To access the Power Properties control panel	54
To remove the internal battery	55
To set the real-time clock	55
To display the time on the taskbar	56
To set SNTP	57

TOUCH SCREEN DISPLAY

The QuickPanel View has an integrated flat-panel color or monochrome display, depending on model. The color model is backlit, measures 5.7" diagonally, and uses passive STN technology. The monochrome model is backlit, measures 5.7" diagonally, and uses passive FSTN technology.

The resolution of the color display is 320 x 240 pixels and 65,536 colors; the resolution of the monochrome display is 320 x 240 pixels and 256 shades of gray.

A backlight timer is featured on all models. You can extend backlight life by turning the backlight off automatically.

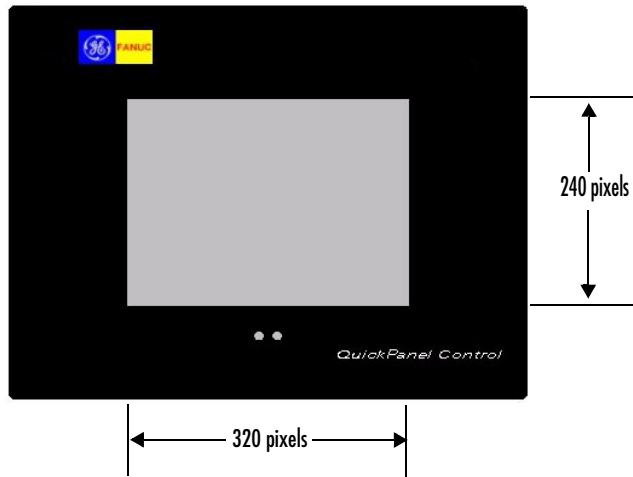

To adjust the display brightness (color models only)

1. In the Control Panel, double-tap  **Display** and choose the **Brightness** tab.

The **Brightness** dialog box appears.

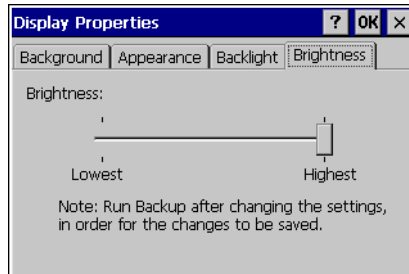



2. Drag the **Brightness** slider between Lowest and Highest.
3. Tap **OK** to exit the control panel.
4. To save the settings, run  **Backup** (see page 16).

To adjust the display contrast (monochrome models only)

1. In the Control Panel, double-tap  **Display** and choose the **Contrast** tab.

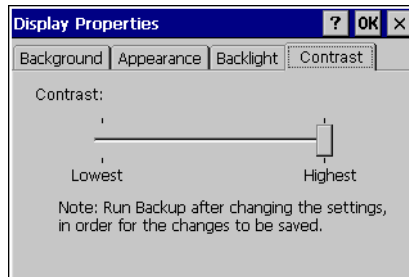
The **Contrast** dialog box appears.



2. Drag the **Contrast** slider between Lowest and Highest.
3. Tap **OK** to exit the control panel.
4. To save the settings, run  **Backup** (see page 16).

To set backlight for auto turn off

1. In the Control Panel, double-tap  **Display** and choose the **Backlight** tab.

The **Backlight** dialog box appears.

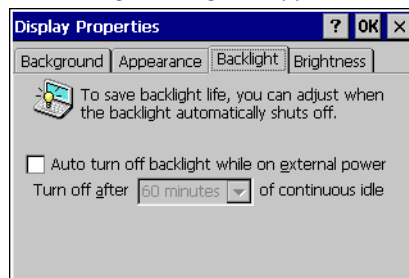

2. Select Auto turn off backlight while on external power.
3. Tap **OK** to exit the control panel.
4. To save the settings, run  **Backup** (see page 16).

Touch Screen

The QuickPanel View display is coupled to a resistive touch panel with 12-bit resolution. When the QuickPanel View is properly calibrated, this translates into a grid of touch cells on the face of the display. Although you can use your finger to activate the touch screen, use of a blunt stylus is recommended.

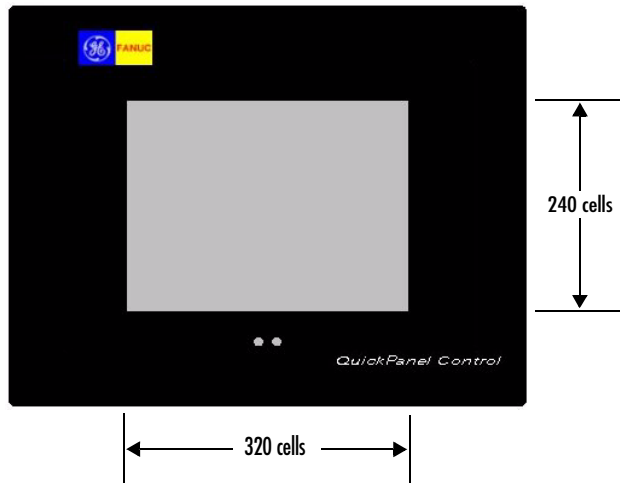

To calibrate the touch screen

1. In the Control Panel, double-tap  **Stylus**.

The **Stylus Properties** dialog box appears.

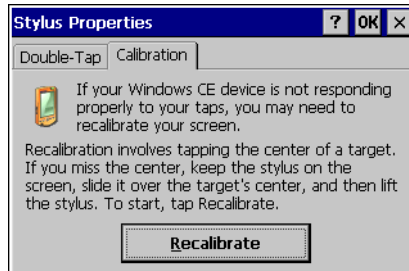

2. Choose the **Calibration** tab.
3. Tap the **Recalibrate** button.

A cross hair target is displayed.

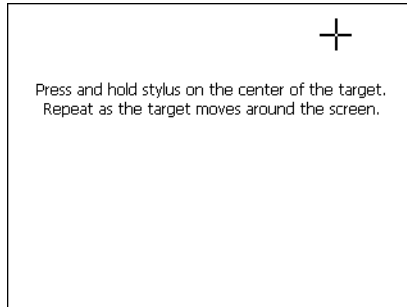

4. Follow the directions given to calibrate the touch screen.
5. Tap the screen to preserve the new setting or wait out the time limit to revert to previous settings.

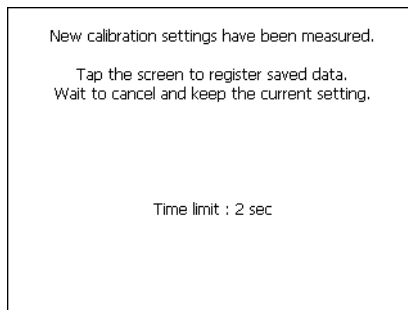

6. To save the settings, run  **Backup** (see page 16).

To set the double-tap sensitivity

1. In the Control Panel, double-tap  **Stylus**.

The **Stylus Properties** dialog box appears.

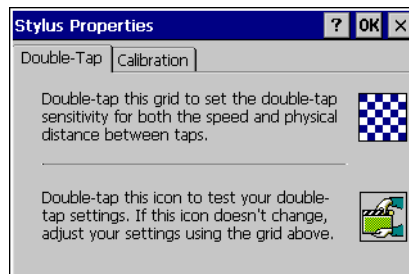

Detailed Operation

Touch Screen Display

2. Choose the **Double-Tap** tab.
3. Double-tap the grid to enter a setting.
4. Double-tap the test icon to check the setting.

If the test icon doesn't change when you double-tap it, double-tap the grid again.

5. Tap **OK** to finish.
6. To save the settings, run  **Backup** (see page 16).

KEYBOARD

The QuickPanel View can be configured to use a software emulation keyboard as a operator data input devices. .

Soft Input Panel

The Soft Input Panel (SIP) is a touch screen version of a standard keyboard, which can be used in place of a standard hardware keyboard.

An icon in the system tray lets you view or hide the SIP.



To show/hide the Soft Input Panel

- On the system tray of the task bar, double-tap the  icon. The Soft Input Panel appears/disappears.

Note: When the SIP is visible, it can be dragged around the screen by its title bar to reveal different parts of the screen that would be obstructed from view by the SIP.

To display the Soft Input Panel icon in the system tray

1. In the Control Panel, double-tap  **Input Panel**.

The **Input Panel Properties** dialog box appears.

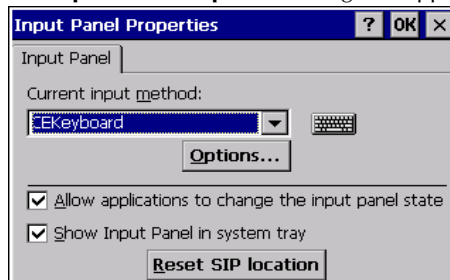

2. Select the **Allow applications to change the input panel state** check box.
3. Select or clear the **Show Input Panel in system tray** check box.
4. Tap **OK**.
5. To save the settings, run  **Backup** (see page 16).

The Soft Input Panel has two basic configurations: **Small key** and **Large key**.

Detailed Operation

Keyboard

Small Key configuration: Provides a standard QWERTY key layout with numeric keys at the top row as illustrated in the following picture.

Input Panel															
Esc	1	2	3	4	5	6	7	8	9	0	-	=	↩		
Tab	q	w	e	r	t	y	u	i	o	p	[]			
CAP	a	s	d	f	g	h	j	k	l	;	'				
Shift	z	x	c	v	b	n	m	,	.	/		↵			
Ctrl	Alt	~										↓	↑	←	→

Small key: lower case

Uppercase characters are accessed by pressing the SHIFT key once. This is equivalent to holding down the SHIFT key on a conventional keyboard. The SHIFT key is active while the next key is pressed then reverts back to its unselected state. The CAP key does the same thing as SHIFT but does not revert to lower case after another key is pressed. Rather, the Soft Input Panel remains in the Uppercase mode until the CAP key is pressed again. The CTRL and ALT keys behave the same as the SHIFT key.

Input Panel															
Esc	!	@	#	\$	%	^	&	*	()	_	+	Del		
Tab	Q	W	E	R	T	Y	U	I	O	P	{	}			
CAP	A	S	D	F	G	H	J	K	L	:	"				
Shift	Z	X	C	V	B	N	M	<	>	?		↵			
Ctrl	Alt	~										↓	↑	←	→

Small key: upper case

Large Key configuration: Provides alphabetic or numeric keys alone. No numeric keys are displayed at the top of the alpha panel; alpha keys are not displayed on the numeric panel.

Input Panel															
Esc	q	w	e	r	t	y	u	i	o	p		↩			
Tab	a	s	d	f	g	h	j	k	l	*					
Shift	z	x	c	v	b	n	m	,	.	/		↵			
123	Ctrl	Alt	@	&								,	.	/	?

Large key: lower case

As with the small key configuration, upper or lower case alpha keys can be displayed by using the SHIFT key.

Input Panel												
Esc	Q	W	E	R	T	Y	U	I	O	P	Del	
Tab	A	S	D	F	G	H	J	K	L	*		
Shift	Z	X	C	V	B	N	M	;	'	←		
123	Ctl	Alt	@	&				,	.	/	?	

Large key: upper case

Pressing the **123** key once locks the panel in numeric mode until the **123** key is pressed again.

Input Panel												
~	1	2	3	4	5	6	7	8	9	0	↵	
Tab	!	~	#	\$	%	^	-	()	£		
←	→		_	+	=	\	:	"			←	
123	Ctl	Alt	<	>				,	.	{	}	

Large key: numeric

To change key configurations

1. In the Control Panel, double-tap  **Input Panel**.

The **Input Panel Properties** dialog box appears.

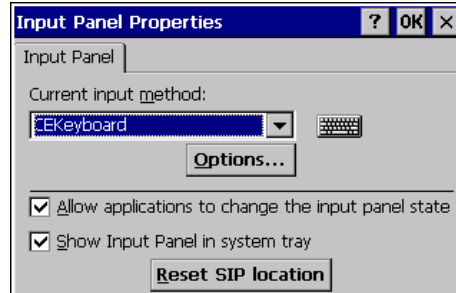

2. From the **Current input method** list, choose **CE Keyboard**.
3. Tap **Options**.

The **Soft Keyboard Options** dialog box appears.

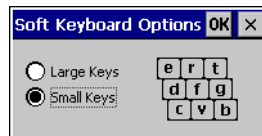

4. Select **Large Buttons** or **Small Keys**.

A preview of the key size is displayed on the dialog box.

5. Tap **OK** twice to finish.
6. To save the settings, run  **Backup** (see page 16).

To reset SIP location

In the event the user accidentally drops the SIP off screen and can't drag it back on screen, the following steps will reset the SIP to the centre of the screen.

1. In the Control Panel, double-tap  **Input Panel**.

The **Input Panel Properties** dialog box appears.

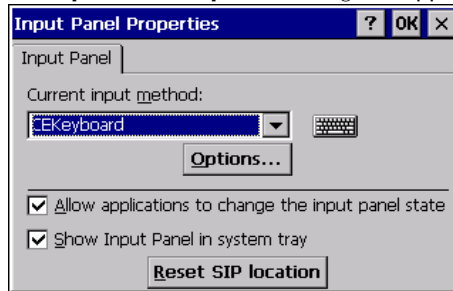

2. Select **Reset SIP location**.

COMMUNICATION PORT

The QuickPanel View has one serial data communication port (COM1).

COM1- Serial

The COM1 port is a general purpose bidirectional serial data channel that supports the EIA232C and EIA485 electrical standards. The COM1 port can be accessed and configured:

- as a direct or dial-up remote networking connection.
- from a user-created application program.

A connection can be configured to reside on a network supporting a TCP/IP protocol.

A DB25S (female) connector, mounted on the bottom of the enclosure, provides standard signals as described in the following table.

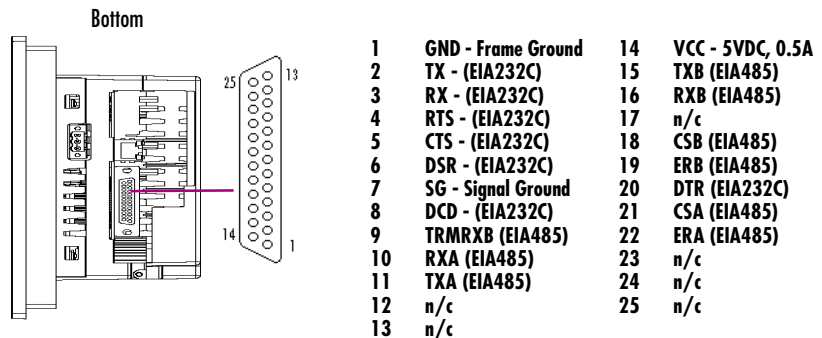

Note: Pin 14 is fused with a field-replaceable, 1.0A fast-blow fuse.

Recommended Cabling for TIA/EIA422 or TIA/EIA485

The COM1 port on the QuickPanel View provides connections to devices, which support either TIA/EIA422 or TIA/EIA485. These electrical standards specify a differential signaling technique which provides high data rates, long distances and good noise rejection. The standards do not address signal encoding (protocol), connectors, or cabling. However, certain characteristics of interfacing these devices should be considered in order to ensure reliable connections.

- Connections** Connect nodes in a daisy chain fashion. Do not connect in other arrangements, especially "star." The standards do not specify the maximum number of nodes or devices that can be connected to a TIA/EIA 422 or 485 network. Instead, the standards limit the number of electrical connections by specifying that a maximum of 32 unit loads (UL) may be connected. The QuickPanel View presents one UL.
- Interconnect media** Always use twisted pair cabling and group complimentary signals into conductor pairs; TXA with TXB, for example. Use a cable with a characteristic impedance of 100 ohms to 120 ohms. A wire gauge of 24 AWG is commonly used. Maximum cable length is 4,000' (1,219.2m), but may be less due to cable impedance, connection quality, data rates, and other factors.
Shield is optional. See "Shielding" on page 38.
- Termination** Always provide proper termination at each end of the 422/485 network. The QuickPanel View provides built-in termination resistance when pin #9 (TRMRXB) is connected to pin #10 (RXA).
Caution: Do not terminate every node. Only terminate the end nodes.
- Grounding** A signal return path between transmitting and receiving devices must be provided. This return path is separate from the Rx and Tx data lines and the other 422/485 signals supported by the QuickPanel View, and may be provided by a separate conductor in the cable. Connect both ends of the signal return conductor to Signal Ground (pin #7). Shielding or use of a twisted pair for this connection is not necessary.
For installations where all devices are in the same cabinet and have the same ground potential between devices, connecting Signal Ground between all the devices on the 422/485 network is adequate to ensure proper voltage levels at the devices.
However, if there is a difference in ground potential between devices, such as when the devices are in widely separated cabinets, then signal grounds on a 422/485 network should not be tied together. The cable shield and cable ground should be connected together at only one device, closest to the earth ground connection.
The signal and frame grounds of the QuickPanel View are capacitively coupled, but in some devices these ground references are connected together. Connect Signal Ground (pin #7) to Frame Ground (pin #1) and then to earth ground on the QuickPanel View only in the circumstance where the other devices separate their signal and frame grounds and the QuickPanel View is the only device with frame and signal ground connected to earth ground.

Shielding



Shielded cable is required for compliance with CE and FCC requirements. The cable shield should be connected to the metal connector shell or by pin #1 of the QuickPanel 25-pin serial connector. Shield and cable ground (pin #7 of the 25-pin connector or pin #5 of the 9-pin connector) should not be connected directly together.

The Frame Ground (pin #1) of the QuickPanel View should be used for attaching the cable shield in these applications.

Caution: Do not connect Signal Ground (pin #7) to Frame Ground (pin #1) on the QuickPanel View, except in the specific and limited circumstances noted in the Grounding section on page 37.

Working with the COM port

To add a new remote networking serial connection

1. From the  **Start** menu, tap  **Settings**, then  **Network and Dial-up Connections**.

The **Connection** window appears.

2. Double-tap  **Make New Connection**.

The **Make New Connection** wizard appears.

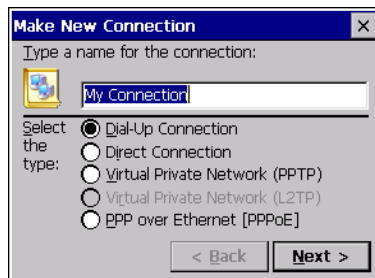

3. Type a name for the new connection.
4. Choose a connection type. If you are configuring a Modem, choose **Dial-Up Connection**. If you have a Device, select **Direct Connection**.
5. Tap **Next**.

The **Modem** or **Device** Connection window appears, depending on the connection type.

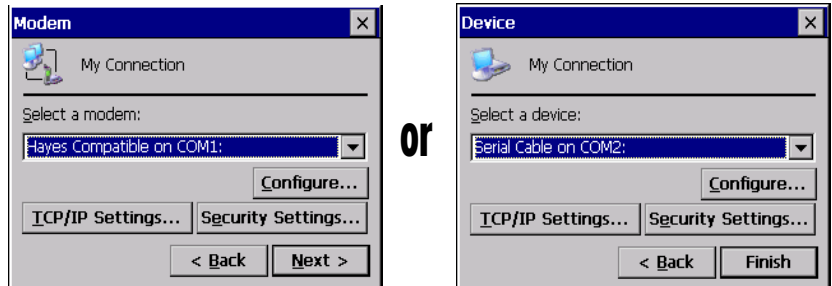

6. From the list, choose the modem or device you want to use. (If a serialCF card is inserted, it is available in the device list).

You can **Configure** your device or **TCP/IP Settings** at this time if you wish.

7. Tap **Finish** for direct connection (Device dialog box) or **Next** for dial-up (Modem dialog box).

If you are adding a dial-up connection the following dialog box appears.

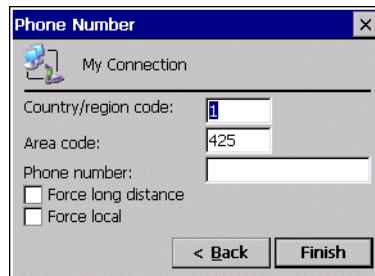

8. Type the destination **Country/region code**, **Area code**, and **Phone number** in the appropriate boxes.
9. Select or clear the **Force Long Distance** or **Force Local** check boxes.
10. Tap **Finish**.

To add a virtual private network or PPP over Ethernet

1. From the **Start** menu, tap **Settings**, then **Network and Dial-up Connections**.

The **Connection** window appears.

2. Double-tap **Make New Connection**.

Detailed Operation

Communication Port

The **Make New Connection** wizard appears.

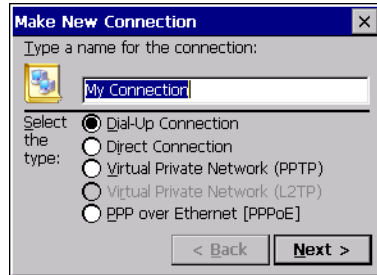

3. Type a name for the new connection.
4. Choose a connection type. Select **Virtual Private Network** to configure a VPN connection. Select **PPP over Ethernet** for a PPPoE connection.
5. Tap **Next**.

The **VPN** or **PPPoE** Connection window appears, depending on the connection type.

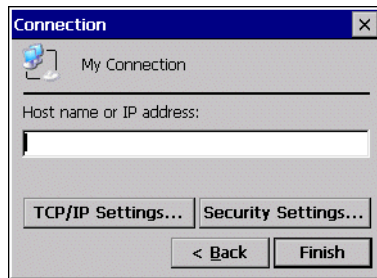

or



6. Enter the Host Name or IP address for a VPN connection, or a PPPoE Service Name for a PPPoE connection.
You can configure your **TCP/IP Settings** at this time if you wish.
7. Tap **Finish**.

To change the default device properties

1. From either the Device or Modem dialog box, tap **Configure**.

The **Device Properties** dialog box appears.

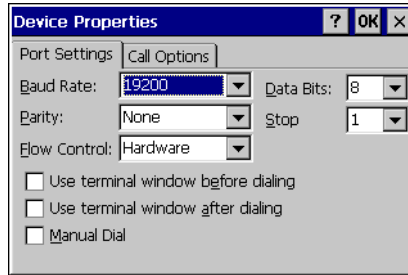

2. In the **Port Settings** tab, choose settings for all connection preferences.
3. If the connection is for terminal emulation, select or clear the terminal-related check boxes.

You can use the QuickPanel View to emulate a terminal attached via a modem link (Hayes compatible) to COM1. A terminal emulation definition is added as a unique session.

To change the default TCP/IP settings

1. Obtain correct TCP/IP settings from your network administrator.
2. From either the **Device, Modem, PPPoE Connection, or VPN Connection** dialog box, tap **TCP/IP Settings**.

The **TCP/IP Settings** dialog box appears.

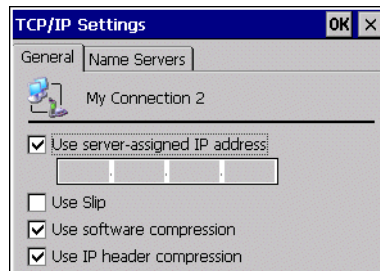

3. Use the TCP/IP settings from your internet provider.

CF PORT

To enhance the QuickPanel View's capabilities with additional flash memory, the unit is equipped with a CF (Compact Flash) Type 2 port on its side.

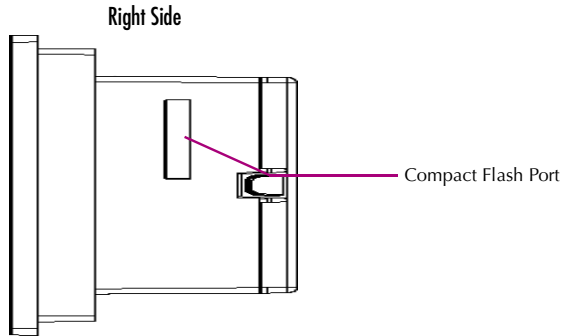

A CF card is inserted in this port with its front facing the front panel of the unit (the narrow side slot on the card should be toward the top). The card should slide in easily—to avoid damage, do not force it.

Note: For full protection from electrostatic discharge, peel off the paper label on the side of the CF card facing away from the bezel to allow contact between the card and the internal frame ground contacts on the CF connector.

The Copy Project to Flash Card utility (see page 20) lets you transfer Machine Edition projects between QuickPanel View units via CF Cards.

No Compact Flash cards are supplied with the QuickPanel View. A list of cards (and other devices) that have been tested and are compatible can be found by visiting <http://globalcare.gefanuc.com>, then select the Operator Interface category, then select the QuickPanel View product name.

The CF port in the QuickPanel View only supports 3.3v CF cards. 5v CF cards are not supported.

Caution: Do not remove power while the system is writing to the CF card, such as when copying a Proficy Machine Edition project. Removing power while writing may lead to data loss and file or CF card corruption. To ensure the system completes writing to flash and closes all files, see "Shutdown" on page 4.

ETHERNET

The QuickPanel View is equipped with a 10BaseT/100BaseTx auto-negotiate Ethernet port (IEEE802.3), and you can connect an Ethernet network cable (unshielded, twisted pair, UTP CAT 5) to the unit via the RJ45 connector on the bottom of the enclosure. LED indicators on the port indicate channel status. Access to the port is possible either by Windows CE network communications, or by your custom application. The following diagram shows the location, orientation, and pin out of the Ethernet port.

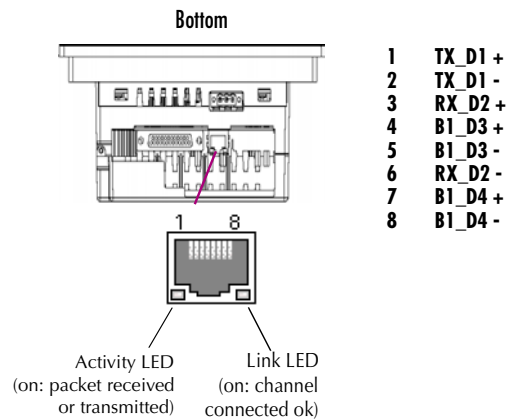

There are two methods for setting an IP address on the QuickPanel View:

- **DHCP (Dynamic Host Configuration Protocol).** This is the default method that is carried out automatically.

Note: There must be a DHCP server on the connected network for a valid IP address to be assigned. Contact your network administrator to ensure correct DHCP server configuration.

- **Manual method.** The user uniquely specifies the numeric addresses for the QuickPanel View, the Subnet Mask (if applicable), and the Default Gateway.

Note: Use a crossover cable to connect the QuickPanel View to a PC directly; when connecting to a LAN HUB, use a straight through cable. Contact your network administrator if you require further information.

To set an IP address

1. From the Control Panel, tap  **Network and Dial-up Connections**.

The **Connection** window appears.



2. Select a  connection and choose  **Properties**.

The **Built-in Ethernet Port Settings** dialog box appears.

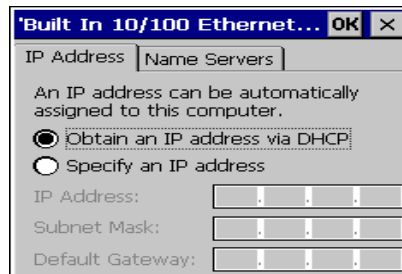

3. Select a method:
 - **Obtain an IP address via DHCP** (automatic).
 - **Specify an IP address** (manual).
4. Enter the **IP Address**, **Subnet Mask** and **Default Gateway** numbers obtained from your network administrator (manual method only).
5. Tap **OK**.
6. To save the settings, run  **Backup** (see page 16).

If the DHCP method was selected, the network server will assign an IP address while the QuickPanel View is initializing. (You must be connected to the network).

After setting an IP address for the QuickPanel View, you can access any network drives or shared resources for which you have permission.

To set up access to a Windows network

1. In the Control Panel, double-tap  **System**.

The **System Properties** dialog box appears.

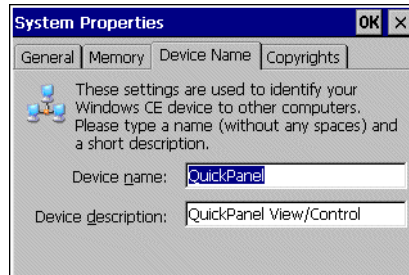

2. On the **Device Name** tab, in the **Device name** box, type a unique name for your QuickPanel View. In the **Device description** box, type a description.
3. Tap **OK**.
4. In the Control Panel, double-tap  **Owner**.

The **Owner Properties** dialog box appears.

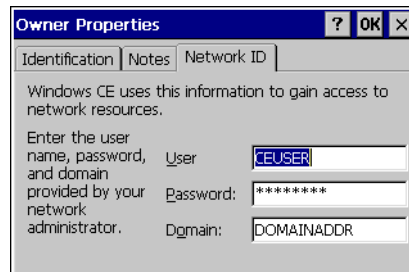

5. On the **Network ID** tab, type your assigned **User name**, **Password** and **Domain**.
6. Tap **OK**.
7. To save the settings, run  **Backup** (see page 16).

Using Windows CE Explorer, you can now access anything on your local network for which you have permission.

To access a remote resource on a Windows network

1. Start  **Windows Explorer**.

The **Explorer** window appears.

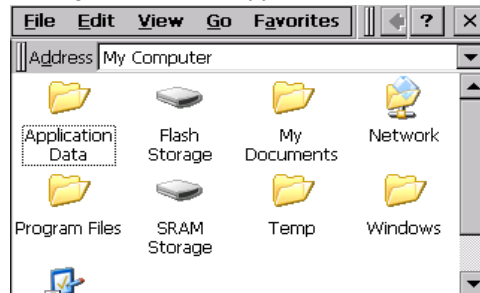

2. Type in the **Address** box, or choose from a list, the path to a remote resource.

For example '\\MyRemoteComputer\MyFolder' specifies the folder named 'MyFolder' on a computer with the name 'MyRemoteComputer'.

3. Press **ENTER**.

The resource specified is displayed as a collection of files and folders. It can take a few moments to retrieve the data from your local network.

Note: You can use the NET command from the shell to map a network resource to the QuickPanel View for frequent access. The resource then appears in the

 **Network** folder.

EXPANSION BUS

An expansion bus is included with the QuickPanel View, and optional modules that mount directly to it are available. For more information on expansion modules, contact your distributor.

The expansion bus connectors are accessed by opening the back of the unit.

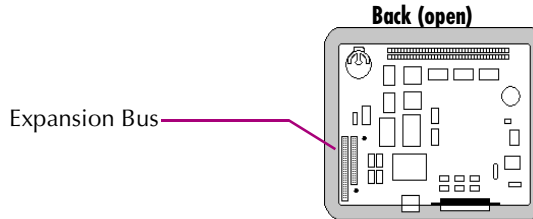

Caution: Remove power from the QuickPanel View before opening the back. Working on a “live” unit may result in damage to equipment and injury to personnel. Always use anti-static precautions (i.e. grounded wrist strap) when accessing the interior of the unit. Do not allow conductive material, liquid or solid, to contact the electronics of the QuickPanel.

Caution: Ensure all pins are properly aligned when inserting expansion cards. Misalignment could cause damage to the QuickPanel View and/or the expansion card.

DIP SWITCHES

The QuickPanel View is equipped with four DIP switches that each control separate functions.

DIP switches are set to “OFF” by default in the factory. DIP switch 2 is the Force Startup switch. Turning this switch on forces the startup applications to run when the operating system is started.

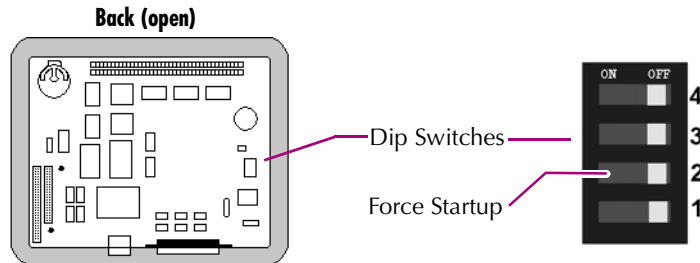

When the switch is set to “OFF”, the QuickPanel View operates normally, displaying the startup splash screen. You can skip running the startup applications by tapping the “Don’t run StartUp Programs” button on the startup splash screen.

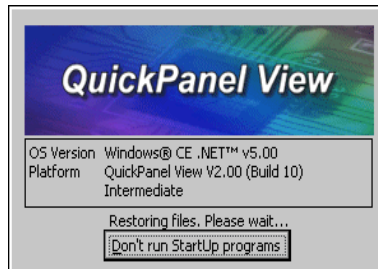

When the switch is set to “ON”, the startup programs are forced to run and the “Don’t run Startup Programs” button is not available on the startup splash screen.

Note: Do not adjust switches other than switch 2. They are reserved for factory functions.

To configure startup behavior with DIP switch 2

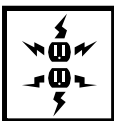

Caution: Remove power from the QuickPanel View before opening the back. Working on a “live” unit may result in damage to equipment and injury to personnel. Always use anti-static precautions (i.e. grounded wrist strap) when

accessing the interior of the unit. Do not allow conductive material, liquid or solid, to contact the electronics of the QuickPanel.

1. **Open the back cover of the QuickPanel View.**
2. **Locate the DIP switches and set DIP switch 2 to "ON".**

The startup applications are now forced.



Note: Do not adjust the other switches. They are reserved for factory functions.

MEMORY

The QuickPanel View supports a variety of memory subsystems to ensure the requirements of your application are met. All system memory is tied directly to the microprocessor's address and data busses for fastest access. To increase DRAM by up to 64 MB, a 100-pin DIMM memory expansion slot is also included.

Flash Memory

This 32 MB block of non-volatile memory is the main long-term program storage for the QuickPanel View, operating like a virtual hard drive from the point of view of Windows CE. It is divided into two areas, of which only one is accessible from Windows CE Explorer. The  **Flash Storage** folder represents a 16 MB block of memory available for long-term storage of user application programs. Another 16 MB block is used to store the Windows CE operating system, and is not directly accessible from Windows CE Explorer.

The operating system and all user application programs are transferred from Flash to DRAM for execution. Any user additions to the  **Windows** folder are retained in  **Flash Storage** when the  **Backup** utility is run.

FLASH memory has a limited write-cycle lifetime. That is, the physical memory devices wear out after approximately 100,000 cycles (minimum), so it is advisable to limit file operations such as copy, delete, etc.

The write cycle is much slower for FLASH than it is for other portions of RAM, therefore FLASH is not recommended for the storage of program variables, or any data items whose values are dynamic.

Flash memory can optionally be added with a CF Card, which will appear as the  **PCFlash Storage** folder.

Caution: Do not remove power while the system is writing to flash memory, such as when downloading a Proficiency Machine Edition project. Removing power while writing may lead to data loss and file system corruption. To ensure the system completes writing to flash and closes all files, see "Shutdown" on page -4.

To add External Flash memory with a CF Card

- Insert a Compact Flash card into CF Port (see page 42).

The unit immediately reads the new secondary storage. If the disk requires formatting, you will be prompted to do so.

New memory appears in Windows CE Explorer as  **PCFlash Storage**.

External flash memory devices are named after their types of connection and order of attachment. For example, if you connect two flash memory devices, one via the CF port and one via the fieldbus connector, the first device connected device is named *PCFlash Storage*, and the second device is named *PCFlash Storage2*. At powerup, a CF port device is recongnized and named first. Otherwise, the name depends on connection order.

SRAM Memory

This 512 KB block of static RAM is battery-backed to provide data retention through a power cycle. This memory block is shared by the operating system and user applications. A portion of the SRAM memory, represented as the  **SRAM Storage** folder, operates as a virtual hard drive and is accessible from the Windows CE Explorer. Typical application programs create files in this folder in which to store critical program data.

The portions of SRAM memory used by the operating system and by user applications varies between models.

DRAM Memory

The QuickPanel View is equipped with 32 MB of dynamic RAM. Part of the DRAM (13.2 MB) is reserved for the Windows CE operating system and is not accessible by user applications. The other 18.8 MB is split between two functions: an object store for temporary file storage, and the main memory for running programs.

Typically, compressed programs stored in FLASH are expanded and moved to DRAM for execution. Temporary storage of program variables or data files is also provided by DRAM—any data stored in DRAM will not be retained through a power cycle.

The split between program memory and storage memory may be adjusted as necessary to make more room for one or the other, depending on your specific application needs. For example, if you find that an application is short of memory, use the System Properties dialog box to alter DRAM memory allocation.

Caution: Setting Program Memory too low may prevent additional applications from starting , or may cause currently running applications to fail due to lack of memory. Setting Storage Memory too low may prevent the saving of files into the object store portion of the file system, which may also cause application failures.

To change the DRAM memory allocation

1. In the Control Panel, double-tap  **System**.

Detailed Operation

Memory

The **System Properties** dialog box appears.

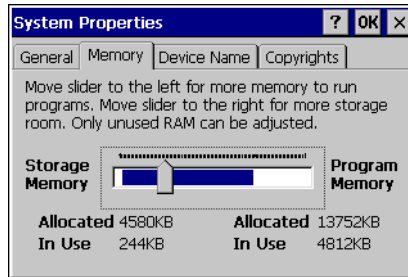

2. On the **Memory** tab, drag the slider to divide the DRAM into Storage and Program memory.

The amount of memory allocated to and used by each area is displayed numerically. The blue bar indicates the current amount of unallocated DRAM and determines the boundaries within which the slider can move.

3. Tap **OK** to apply the new setting.
4. To save the settings, run  **Backup** (see page 16).

Boot Loader ROM

The Boot Loader ROM provides 512 KB of non-volatile storage for the QuickPanel View's initialization program. This program configures the QuickPanel View hardware then starts the operating system's execution. This memory is not accessible from Windows CE Explorer, nor should any attempts be made to modify the contents of this ROM.

Memory Expansion Slot

The QuickPanel View is equipped with a 100-pin DIMM memory expansion slot which lets you increase DRAM to a total of 96 MB.

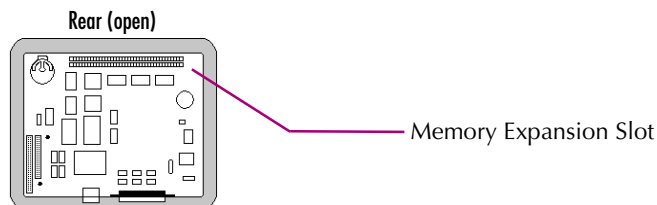

Caution: Remove power from the QuickPanel View before opening the back. Working on a “live” unit may result in damage to equipment and injury to personnel. Always use anti-static precautions when accessing the interior of the

QuickPanel View. Do not allow conductive material, liquid or solid, to contact the electronics of the QuickPanel.

To install additional DRAM

1. Disconnect AC power from the 24VDC supply.
2. Open the rear access panel.
3. Insert the new DIMM carefully into the expansion slot, noting the orientation of the pin locators. When the DIMM is fully seated, lift each side clip until it clicks into place.

OTHER SUBSYSTEMS

Power Management

The QuickPanel View's Power Properties control panel displays the status of the backup battery. The  Battery Very Low Or Missing icon displays in the taskbar when the battery is either missing or very low.

To access the Power Properties control panel

1. In the Control Panel, double-tap  Power.

The Power Properties dialog box appears.



Battery Backup

Auxiliary backup power for the real-time clock and SRAM is provided by a **non-rechargeable**, internal lithium battery (+3VDC, BR2032), ensuring that no loss of data occurs when the main 24VDC supply is removed. Backup power is enabled or disabled by installing or removing the battery, accessed via the rear panel as shown in the following illustration.

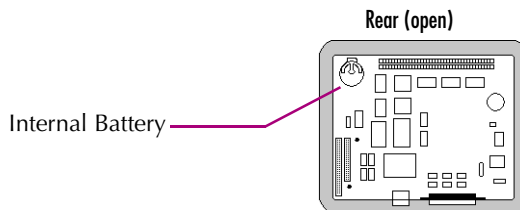

Caution: Remove power from the QuickPanel View before opening the back. Working on a “live” unit may result in damage to equipment and injury to personnel. Always use anti-static precautions when accessing the interior of the QuickPanel View. Do not allow conductive material, liquid or solid, to contact the electronics of the QuickPanel.



To remove the internal battery

1. Disconnect AC power from the 24VDC supply.
2. Open the rear access panel.
3. Release the battery by *gently* lifting it from the completely exposed side, past the small protrusions. To avoid breaking the battery retainer clips, do not apply excessive upward pressure.
4. Slide the battery out of its carrier, noting the arrow on the carrier indicating the direction of removal.

Real-time Clock

The QuickPanel View has a programmable real-time clock capable of reporting the current time in Year/Month/Day/Hour/Minute/Second. The time is set from the Windows CE interface and retained through a power cycle if battery backup is available. Automatic adjustment for daylight savings time is enabled by a check box within the dialog box. The time can be displayed in the system tray on the task bar. Help for this dialog box is activated by selecting the question mark.

To set the real-time clock

1. In the  Control Panel, double-tap  **Date/Time**.

The **Date/Time Properties** dialog box appears.

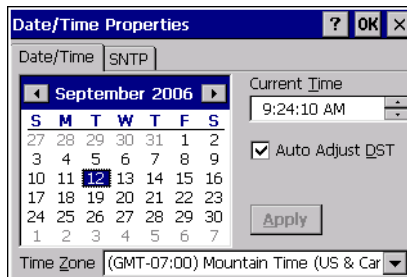

Note: Tap Apply after making changes in any box.

2. To modify the date, select the **Date/Time** tab.
3. Tap the year to choose a new year; tap the month to choose a new month.
4. Tap a date to specify the day of month.
5. From the **Time Zone** box, choose your zone.
6. Select **Auto Adjust DST** to have the clock automatically compensate for daylight savings time.
7. In the **Current Time** box, adjust the hours, minutes and seconds.
8. Tap **OK** to finish.

The time can be displayed in the system tray on the task bar.

To display the time on the taskbar

1. From the  **Start** menu, choose  **Settings**, then  **Taskbar and Start Menu...**

The **Taskbar Properties** dialog box appears.

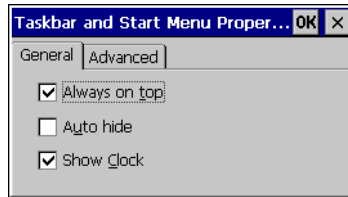

2. On the **Taskbar Options** tab, select **Show Clock**.
3. Tap **OK**.

An hours and minutes display now appears in the taskbar.

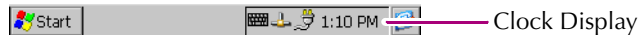

Configuring SNTP

There are two levels of Network Time Protocol (NTP) time servers available on the Internet.



First-level time servers are primarily intended to act as source time servers for second-level time servers. First-level time servers may also be capable of providing mission-critical time services. Some first-level time servers may have a restricted access policy.

Second-level time servers are intended for general SNTP time service needs and usually enable public access. It is recommended that you use second-level time servers for normal SNTP time server configuration because they are normally located on a closer network that can produce faster updates.

It is recommended that you research any time server selection to ensure that it can meet your specific time server requirements. More information and a list of SNTP time servers can be found at <http://support.microsoft.com/kb/262680/>.

If the time on the time server is more than the threshold value away from the current time on the QuickPanel View, then the time is not updated. Setting the Threshold to 0 tells the utility to always accept the time from the server. This setting would be useful in a case where the backup battery has died and the QuickPanel View was power cycled, since the internal clock would have reset back to January 1, 1980 12:00 am.

To set SNTP

1. In the  Control Panel, double-tap  **Date/Time**.

The **Date/Time Properties** dialog box appears.

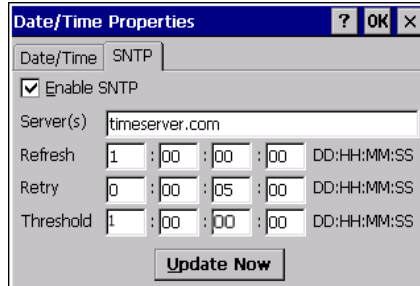

Note: Tap Apply after making changes in any box.

2. To add or modify SNTP settings, select the SNTP tab.
3. To enable SNTP, ensure the **Enable SNTP** check box is selected.
4. Enter the time server name in the **Server(s)** field.
5. Set the **Refresh**, **Retry**, and **Threshold** parameters.
6. Tap **Update Now** to update SNTP settings immediately.
7. Tap **OK** to finish.

A1

Design Specifications

The specifications listed in this appendix are the design goals for the QuickPanel View. In most cases the “as built” or tested specifications are identical. See page 63 for a list of agency approvals for environmental service and safety.

Physical

Enclosure dimensions	Height: 4.852 in (123.2mm) Width: 6.14 in (156mm) Depth: 2.76 in (70mm)
Bezel dimensions	Height: 6.68 in (169.6mm) Width: 8.50 in. (215.9mm) Depth: 1.13 in (28.7mm) - using small cutout 0.28 in (7.11mm) - using large cutout
Weight	2.5lb (1.16 kg)
Cutout dimensions	Small: Height: 4.86", +0.103", -0" (123.5mm, +2.6mm, -0mm) Width: 6.14", +0.55", -0" (156mm, [+14mm, -0mm]) Large: Height: 6.12", +/- 0.02" (155.45mm [+/- 0.51mm]) Width: 7.95", +/- 0.02" (202mm, [+/- 0.51mm])

DC Power

Input Voltage	12 to 30 VDC
Power Dip Tolerance	-30% nominal input voltage, 10msec
Insulation Resistance	268Mohm @1000V frame ground to 0V 366Mohm @1000V frame ground to 24V

Design Specifications

Real Power	12 W Power requirement nominal for startup when DC supply is already powered and stable. Applying power to the supply while connected to the QuickPanel View increases total inrush current requirements. In this case, supply should be rated at 10x the nominal startup current. Otherwise, an interposing relay or switch must be used between the DC supply and the QuickPanel View. NOTE : For compliance with UL 1604, switches or relays in-line with the DC power wiring cannot be used in hazardous locations.
Connector (Vendor, p/n)	Phoenix Contact, 1777992
Power Supply Conductor Size	12 to 18 AWG For compliance to CE Mark, the isolated frame ground must be connected. Recommended frame ground connection is via the shortest possible route, using a 14 AWG conductor.

Display

Size	5.75" 14.6 cm
Colors	65,536 (color) 256 shades of gray (monochrome)
Resolution	320 X 240
Fabrication	Passive STN transmissive (color) Passive FSTN (monochrome)
Backlight	Cold Cathode Fluorescent (CCFL) - rated half life: 40,000 hours (color) Cold Cathode Fluorescent (CCFL) - rated half life: 50,000 hours (monochrome) Backlight not field replaceable.

Front Panel

Bezel Material	Valox 3706 For material specifications, visit www.gepolymerland.com
Membrane Material	Lexan HP60 For material specifications, visit gestructuredproducts.com
LEDs	
Left (bottom on color model)	Power status indicator (green with power applied, amber if backlight fails)
Right (top on color model)	Programmable tri-color (green, red, amber)

Touch Screen

Type	Resistive, 12 bit
Resolution	X axis- 320 cells Y axis - 240 cells (after calibration)

CPU

Processor	Intel XScale PXA255
Clock speed	300 Mhz

Memory

FLASH	32 MB
SRAM	512KB (Battery Backed)
DRAM	32 MB
ROM	512 KB (Boot loader)

Memory Expansion Slot

Form Factor	100 pin DIMM
Memory Type	SDRAM
Maximum DRAM	64 MB
Maximum Devices/Module	4
Bus Width	32 bits
Bus Speed	100 MHz or faster
Voltage	3.3 VDC
CAS Latency	CL=3
Refresh Type	Self
Refresh Cycle Time	64 ms maximum
Error Correction	Non-ECC
Error Detection	No parity
Buffering	None

Design Specifications

Device Row Addressing	12 Address Lines (A0 to A11)
Expansion Memory Catalog Number	32MB - IC754ACC32MEM 64MB - IC754ACC64MEM

Expansion Ports

Compact Flash Memory	One slot (type 2)
Expansion Bus	One slot

Communication Port

Ethernet	IEEE 802.3 10/100BaseT RJ45 connector Two status LEDs Maximum cable length: 30M
Serial COM1	EIA232C/EIA485, DP25S (female)
Speed	300 bps - 115200 bps
Mounting h/w	M2.6 jackscrew
Fuse	1.0A, 125V fast blow cartridge type, Littlefuse part #154001

Environmental

	Mono	Color
Operating Temperature	14°F to 140°F (-10°C to 60°C)	32°F to 140°F (0°C to 60°C)
Operating Humidity	10% to 85%, non-condensing	10% to 90%, non-condensing
Storage Temperature	-4 to 158°F -20 to 70 °C	-4 to 140°F -20 to 60 °C
Storage Humidity	10% to 85%, non-condensing	10% to 90%, non-condensing
NEMA Rating	4, 4x, and 12 when mounted in a panel (IP65 equivalent)	4, 4x, and 12 when mounted in a panel (IP65 equivalent)

Operational Vibration	IEC 68-2-6 10 - 57Hz, 0.012" peak to peak displacement 57 - 500Hz, 1.0g acceleration	IEC 68-2-6 10 - 57Hz, 0.012" peak to peak displacement 57 - 500Hz, 1.0g acceleration
Operational Shock	IEC 68-2-27 15g, 11ms (sine wave)	IEC 68-2-27 15g, 11ms (sine wave)

Battery

Type	CR2032 (3V, 190mAh, lithium)
Life (Approximate)	5 years

Calendar/Clock

Resolution	1 second
Retention	Life of battery

Agency Qualifications

Model # ES0611 (color)

Model # ES0601 (mono)

Description	Agency Standard or Marking	Comments
North American Safety for Industrial Control Equipment	UL 508/C-UL	Certification by Underwriter's Laboratories to UL standard and equivalent CSA standard
North American Safety for Hazardous Locations Class I, Div. 2, Groups A, B, C, D	UL 1604/C-UL	Certification by Underwriter's Laboratories to UL standard and equivalent CSA standard
Explosive Atmospheres Directive European Safety for Hazardous Locations Equipment Group II, Category 3	ATEX (pending)	Certification in accordance with European directives; refer to Declaration of Conformity and Independent 3 rd Party Assessment Certificate

Design Specifications

Description	Agency Standard or Marking	Comments
Low Voltage Directive European Safety for Industrial Control Equipment	CE	Self-declaration in accordance with European directives; refer to Declaration of Conformity
Electromagnetic Compatibility Directive European EMC for Industrial Control Equipment	CE	Certification by competent body in accordance with European directives; refer to Declaration of Conformity

A2

Troubleshooting

The tables contained in this appendix can be used to identify and remedy problems that can occur with the 6" QuickPanel View.

Power up

Problem	Suggested remedy
Blank screen.	Check all power connections to the QuickPanel View. Note: Left LED glows amber when backlight fails.

Pocket Internet Explorer

Problem	Suggested remedy
Cannot access any URLs when using a dial-up connection to an ISP.	If you have previously set up an IP address on a local Ethernet Network, it must be cleared. Disconnect your Ethernet cable and reboot. Your ISP will reassign an IP address when you reconnect the cable.

Physical Unit

Problem	Suggested remedy
Slow or sluggish touch response.	Ensure that configured I/O or communications channels such as serial or Ethernet are operating without error. These errors can cause higher system overhead leading to delayed response to touch inputs. Ensure that flash drives, internal or external, are operating without error. If the flash drives are highly fragmented or corrupted, reads & writes to the drive can experience significant delays leading to delayed response to touch inputs. Corrupted external flash drives may be corrected with Storage Manager. See "Storage Manager" on page 18.

Problem

After adding expansion memory in the DIMM connector the system won't boot, or, if it does boot, it displays an error message.

Suggested remedy

When the system is first started, observe the screen to notice any memory error messages from the boot loader. If error messages such as the following are seen, "DIMM not 12 row" or "DIMM not 32 bit" or "DIMM Refresh Unsupported", power down the system and remove the memory module.

If the error message is displayed from the Windows CE desktop, also power down the system and remove the memory module. For proper operation, expansion memory modules must meet the requirements stated in the Design Specifications on page 59.

Index

A

- accessing
 - Windows network 45, 46
- adding
 - connections 38, 39
- addresses
 - IP 44
- adjusting
 - display brightness 26, 27

B

- backlight
 - (note) 10, 60
 - set for auto turn off 27
- backup 16
- battery 54
 - specifications 63
 - status 54
- baud rate 41
- bezel 60
- block diagram 12
- boot loader ROM 52
- brightness 26, 27

C

- cabling, COM1 36
 - connections 37
 - grounding 37
 - interconnect media 37
 - shielding 38
 - termination 37
- calibrating
 - touch screen 28
- clock 55
- COM1 36
- communication ports 36, 62
 - locations 10

compact flash

- adding memory 50
- configuring
 - set IP address 44
 - TCP/IP settings 41
- connections
 - adding 38, 39
 - set IP address 44
 - TCP/IP settings 41
 - Windows network 45
- cutout 4
 - see also design specifications

D

- design specifications 59
- device properties, configuring 40
- DHCP (Dynamic Host Configuration Protocol) 43
- dial-up connection 38
- dip switches 48
- displaying
 - real-time clock 56
- double-tap sensitivity
 - setting 28, 29
- DRAM 51
 - partition DRAM memory 51
 - partitioning 51

E

- Emulate PPC 19
- Ethernet 43
 - port settings 44
- expansion bus 47
- expansion busses
 - locations 10
- expansion ports 62
- Explorer, Internet 14

F

- flash 50
- flow control 41
- front panel 10, 60
 - bezel 60
 - LEDs 10, 60
 - membrane 60

I

- input panel 31
 - displaying 31
- Internet Explorer 14
- IP address
 - setting 44

K

- key configurations
 - changing 34
 - large 32
 - small 32
- keyboard 31
- keyboard shortcuts 13

L

- LEDs
 - Ethernet 43, 62
 - front panel 10, 60

M

- Machine Edition 3, 14, 18
- membrane 60
- memory 50, 61
 - adding with CF card 50
 - boot loader ROM 52
 - DRAM 51
 - flash 50

- partition DRAM memory 51
- SRAM 51
- memory expansion slot 52
- modem configuration 38
- mounting
 - dimensions 4
 - hardware 5, 6
 - mounting directions 5, 7
- mounting brackets 7

P

- panel cutout 4
 - see also design specifications
- parity 41
- partitioning
 - DRAM 51
- physical layout 10
- Pocket Internet Explorer 14
- ports
 - communication 36, 62
 - Ethernet 43
 - expansion 62
 - keyboard 31
 - locations 10
 - serial 36
- power management 54
 - control panel 54
- power supply 2
- power supply terminals
 - location 10

- PPPoE 39
- product support 8
- Proficy Machine Edition 3, 14, 18
- programs
 - start menu 14
- proxy server 15

R

- real-time clock 55
 - displaying 56
 - setting 55, 57
- Reboot 17

S

- serial ports 36
- setting
 - double-tap sensitivity 29
 - sensitivity 28
 - IP address 44
 - real-time clock 55, 57
- setup
 - basic 2
 - runtime 3
- shutdown 4
- specifications 59
- SRAM 51
- start menu 14
- startup 3
 - configuring behavior 48
 - force startup switch 48

- stop startup programs 48
- storage card 50, 51
- storage manager 18
- support 8
- switches, dip 48
- System Information 18

T

- Technical Advisor 8
- technical support 8
- terminal emulation 41
- touch screen 28
 - calibrating 28
- troubleshooting 65

U

- utilities
 - backup 16
 - System Information 18

V

- virtual private network 39

W

- Windows CE 13
- Windows network
 - accessing 45, 46