

GFK-1670

[Buy GE Fanuc Series 90-30 NOW!](#)

GE Fanuc Manual Series 90-30

VersaPro Programming Software

1-800-360-6802

sales@pdfsupply.com



GE Fanuc Automation

Programmable Control Products

VersaPro™ Programming Software

User's Guide

GFK-1670C

October 2000

Warnings, Cautions, and Notes as Used in this Publication

Warning

Warning notices are used in this publication to emphasize that hazardous voltages, currents, temperatures, or other conditions that could cause personal injury exist in this equipment or may be associated with its use.

In situations where inattention could cause either personal injury or damage to equipment, a Warning notice is used.

Caution

Caution notices are used where equipment might be damaged if care is not taken.

Note: Notes merely call attention to information that is especially significant to understanding and operating the equipment.

This document is based on information available at the time of its publication. While efforts have been made to be accurate, the information contained herein does not purport to cover all details or variations in hardware or software, nor to provide for every possible contingency in connection with installation, operation, or maintenance. Features may be described herein which are not present in all hardware and software systems. GE Fanuc Automation assumes no obligation of notice to holders of this document with respect to changes subsequently made.

GE Fanuc Automation makes no representation or warranty, expressed, implied, or statutory with respect to, and assumes no responsibility for the accuracy, completeness, sufficiency, or usefulness of the information contained herein. No warranties of merchantability or fitness for purpose shall apply.

The following are trademarks of GE Fanuc Automation North America, Inc.

Alarm Master	Genius	PROMACRO	Series Six
CIMPLICITY	Helpmate	PowerMotion	Series Three
CIMPLICITY 90-ADS	Logicmaster	PowerTRAC	VersaMax
CIMSTAR	Modelmaster	Series 90	VersaPro
Field Control	Motion Mate	Series Five	VuMaster
GENet	ProLoop	Series One	Workmaster

This manual describes the features that are used to program Series 90™-30 PLCs, VersaMax™ PLCs, VersaMax Nano/Micro PLCs, and Series 90 Micro PLCs using the VersaPro™ programming software, Version 2.00.

Revisions to This Manual

This manual and the product online help have been updated to reflect the new features provided by Version 2.00. New features include:

- Support for Series 90-70 PLCs, including Genius redundancy and CPU redundancy over Genius. (Refer to the Important Product Information document, GFK-1671K or later, for a complete list of features supported.)
- Support for additional VersaMax I/O modules and Series 90-30 power supply modules. (Refer to GFK-1671K or later for a list.)
- Usability enhancements:
 - SNF/VCD Import able to swap variable names
 - Multiple instances of VersaPro on the same computer simultaneously communicating to PLCs.
 - Minimum supported Firmware Revisions / Unsupported CPU models
 - Warn if Store to PLC with LM90 folder
 - Block Locking/Unlocking (other than via an import or load)
 - Online Use Tables
 - Print Header / Footer
 - Auto-backup
 - Find local scope variables
 - Size of block reported to the Information Window
 - %R upper limit change
 - Serial number provided in Help About box
 - Site licensing

Content of This Manual

- Chapter 1. Introduction:** Provides an overview of the VersaPro Programming Software components.
- Chapter 2. Working With Folders:** Describes how to create new folders, perform file operations on existing folders and provides an overview of the Folder Browser.
- Chapter 3. Working With Blocks:** Describes how to create and manage blocks and objects in the VersaPro browser. This chapter also describes how to convert blocks between IL and RLD.
- Chapter 4. Working in the LD Editor:** Describes how to customize the LD Editor Window, enter and edit logic, and how to work with variables in the LD editor.
- Chapter 5. Working in the Instruction List Editor:** Describes how to customize the IL Editor Window, enter and edit logic, and how to work with variables in the IL editor. This chapter also provides information on Instruction List operands.
- Chapter 6. Working with the Variable Declaration Table:** Provides an overview of working in the Variable Declaration Table (VDT) and shows how to create and edit variables.
- Chapter 7. Configuring PLC Hardware:** Describes how to access hardware configuration and how to configure Series 90-30 and VersaMax PLC systems.
- Chapter 8. Using Reference and Variable View Tables:** Provides an overview of Reference View Tables (RVT) and Variable View Tables (VVT). Describes how to create and manage data in the view tables.
- Chapter 9. Motion Programming.** Provides an overview of motion programming for the Motion Mate DSM314 motion control module. Describes the Motion, Local Logic, and Cam editors.
- Chapter 10. Communicating with the PLC:** Describes how to connect your computer to the PLC and gives the procedures for common online operations.
- Chapter 11. Working with Fault Tables:** Gives the procedures for viewing the PLC and I/O Fault Tables.
- Appendix A: VersaPro Menus and Toolbars:** Provides summary information about the menus and toolbars available in VersaPro.
- Appendix B: Communications Cabling:** Provides cabling information and diagrams.
- Appendix C: VersaPro License Transfer Procedure:** Describes how to transfer a VersaPro license from one machine to another.
- Appendix D: Using the VersaPro Keyboard:** A quick reference guide to keyboard shortcuts.

Related Publications

GFK-1742	<i>Motion Mate™ DSM314 for Series 90™-30 PLCs User's Manual</i>
GFK-1645	<i>VersaMax™ Micro PLCs User's Manual</i>
GFK-1504	<i>VersaMax™ Modules, Power Supplies and Carriers</i>
GFK-1503	<i>VersaMax™ PLC User's Manual</i>
GFK-1411	<i>Series 90™-30 System Manual</i>
GFK-1065	<i>Series 90™-30 Micro PLC User's Manual</i>
GFK-0356	<i>Series 90™-30 Programmable Controller Installation Manual</i>
GFK-1541	<i>TCP/IP Ethernet Communications for the Series 90™ PLC User's Manual</i>
GFK-1873	<i>VersaMax™ Station Manager Manual</i>

Chapter 1	Introduction.....	1-1
	Welcome to VersaPro.....	1-1
	Installing VersaPro Software.....	1-2
	Starting VersaPro Software.....	1-2
	Multiple Instances of VersaPro.....	1-3
	Using VersaPro – Overview.....	1-3
	The Workbench Window.....	1-4
	Setting Workbench Options.....	1-4
	Setting Display Options.....	1-6
	Setting Autoconnect Options.....	1-7
	Setting Ladder Options.....	1-9
Chapter 2	Working With Folders	2-1
	Creating and Opening VersaPro Folders	2-2
	Creating a New Folder.....	2-2
	To create a new, empty folder:.....	2-2
	To create a new folder based on an existing VersaPro folder:	2-4
	To create a new folder, importing a Logicmaster 90 Folder:	2-6
	To create a new folder, importing logic from a Control folder:	2-8
	Rules for Folder Names and Nickname.....	2-10
	Directory structure and files for a new folder	2-11
	Opening an Existing Folder	2-11
	Using the Folder Browser.....	2-12
	Information Window	2-13
	Context-sensitive Menu	2-14
	Working with Windows in the VersaPro Workspace	2-15
	Folder Operations	2-16
	Closing a VersaPro Folder.....	2-16
	Saving a Folder	2-16
	Deleting a Folder.....	2-16
	Backing Up and Restoring.....	2-17
	Backing Up a Folder	2-17
	Restoring a Folder from Backup.....	2-17
	Restricting Folder Access	2-18
	Locking a Folder	2-18

Contents

Unlocking a Folder.....	2-19
Changing Properties	2-19
Printing Your Program.....	2-20
Printing a Report	2-20
Printing Logic, Variable Declaration Table, or Information Window Contents.....	2-22
Chapter 3 Working With Blocks.....	3-1
Creating, Inserting and Opening Blocks	3-2
Creating a New Block	3-2
Inserting a Block from Another Folder.....	3-3
Opening a Block.....	3-5
Maximum Block Size.....	3-6
Inserting and Editing Objects	3-6
Working with Blocks and Objects in the Folder Browser	3-7
Arranging Blocks	3-7
Viewing and Modifying Block Properties	3-7
Modifying Blocks and Folder Components.....	3-8
To cut blocks:.....	3-8
To copy blocks:	3-8
To paste blocks:	3-9
To copy components as bitmap or text:	3-9
To drag and drop-cut in the Folder Browser:.....	3-9
To drag and drop-copy in the Folder Browser:	3-10
Deleting a Block.....	3-11
To delete a block or View Table:	3-11
To delete the contents of the _MAIN block:.....	3-11
Saving a Block	3-12
To save a block	3-12
Closing Blocks	3-12
Using Editing Operations on Folder Components	3-13
Using Undo and Redo	3-13
Working with Variables while Editing Blocks	3-14
Searching and Replacing in VersaPro.....	3-16
Navigating in VersaPro	3-16
Locating and going to a Rung, Row or Variable.....	3-16

	Locating Names, Instructions, Addresses or Call Statements in Blocks.....	3-17
	Using Search and Replace	3-18
	Performing Syntax Checks	3-20
	Converting Block Logic.....	3-21
	Setting Conversion Variables.....	3-21
	Converting Block Logic	3-22
	Rules for Successful Conversion.....	3-22
	Converting Non-Nested Instructions.....	3-23
Chapter 4	Working in the LD Editor.....	4-1
	Overview of the LD Editor	4-2
	Customizing the LD Editor Window	4-3
	Customizing Ladder display options	4-3
	Adjusting the Zoom Ratio.....	4-4
	Entering Instructions and Instruction Parameters	4-5
	Entering Instructions	4-6
	Entering Instructions using the Function Toolbar	4-6
	Entering Instructions using the Ladder Toolbar	4-8
	Entering Instructions using Keyboard Entry	4-9
	Completing Address and Length Information.....	4-9
	Completing Function Block Parameters.....	4-10
	Assigning Variables to Function Block Parameters	4-10
	Assigning Constants to Function Block Parameters.....	4-13
	Editing Ladder Logic.....	4-14
	Selecting Logic	4-14
	Using Cut, Copy, Paste and Delete in the LD Editor.....	4-15
	Inserting an empty row in the LD Editor	4-16
	To go to the next coil:.....	4-16
Chapter 5	Working in the Instruction List Editor	5-1
	Overview of the Instruction List Editor	5-2
	Customizing the IL Editor Display.....	5-3
	Entering Instructions and Instruction Parameters.....	5-4
	Selecting the Instruction	5-4
	Completing Address and Length Information.....	5-5
	Completing Instruction Parameters	5-5
	Assigning Variables to Instruction Operands.....	5-5

Contents

	Assigning Constants to Instruction Operands	5-7
	Using Cut, Copy, Paste and Delete in the IL Editor	5-8
	Instruction List Operation	5-9
	Constants	5-11
	Functions.....	5-12
	Function Blocks	5-12
	PLC Built-in Functions and Function Blocks.....	5-13
	Nesting of Boolean Expressions	5-17
	Using ENO.....	5-18
	Defining Temporary Variables	5-19
	Error Checking.....	5-19
Chapter 6	Working with the Variable Declaration Table.....	6-1
	Overview of the Variable Declaration Table.....	6-2
	Variable Table Field Descriptions	6-3
	Reserved Words	6-4
	Creating and Modifying Variables	6-5
	To create a new variable or modify an existing variable in the VDT:.....	6-5
	Navigating in the VDT	6-6
	Navigating Using the Mouse or Keyboard	6-6
	Locating a Variable using the Go To Variable Dialog Box	6-7
	Using Cut, Copy, Paste and Drag and Drop in the VDT.....	6-8
	To cut, copy and paste in the Variable Declaration Table:	6-8
	Details on Cutting and Copying.....	6-9
	Details on Pasting.....	6-9
	To drag and drop-cut in the VDT:.....	6-10
	To drag and drop-copy in the VDT:.....	6-10
	Details on Dragging and Dropping in the VDT	6-11
	To drag and drop from the VDT to the LD or IL Editor:.....	6-11
	Details on Dropping a Variable into an Editor	6-11
	Variable Declaration Table Utilities	6-12
	Sorting Variables.....	6-12
	Deleting Variables and the Contents of a VDT.....	6-12
	Saving Edits in the VDT.....	6-13
	Compacting the VDT	6-14
	To compact the VDT:.....	6-14

	Viewing the Highest References Used.....	6-14
	Finding Unused Variables	6-14
	Creating a Cross-Reference Listing of Variables	6-14
	Importing and Exporting Variables	6-15
	To import a variable:	6-15
	Details on Importing an SNF File	6-15
	To export a variable:.....	6-16
	Details on Exporting an SNF File	6-17
	Variable Resolution.....	6-18
Chapter 7	Configuring PLC Hardware	7-1
	Accessing Hardware Configuration 	7-2
	Hardware Configuration Toolbar	7-3
	Using the Parameter Editor.....	7-3
	Editing Tips	7-4
	Undoing Changes.....	7-5
	Error Notification.....	7-5
	Correcting Errors.....	7-6
	Shortcut Keys for HWC	7-6
	Setting Options in Hardware Configuration	7-7
	Configuring a Series 90-30 Rack	7-8
	Changing Rack Type	7-8
	Changing/Configuring Power Supply and CPU	7-9
	Configuring a Power Supply.....	7-9
	Configuring a CPU.....	7-9
	Adding/Configuring Rack Modules	7-10
	Configuring Expansion Racks	7-10
	Deleting Rack Modules	7-11
	Clearing the Rack.....	7-11
	Configuring a VersaMax Modular Rack.....	7-12
	Changing/Configuring the CPU.....	7-13
	Rack/Module Operations	7-13
	Changing/Configuring the Power Supply.....	7-14
	Adding Module Carriers.....	7-14



Contents

Adding Power Supply Booster Bases	7-14
Adding/Configuring Modules	7-15
Configuring Module Parameters	7-15
Deleting Rack Modules	7-16
Deleting Carriers.....	7-16
Clearing the Rack.....	7-16
Configuring VersaMax Expansion Networks	7-16
Loading VersaMax Hardware Configurations.....	7-20
VersaMax Modules with Shared IDs.....	7-20
Configuring a VersaMax Remote I/O Rack.....	7-21
Configuring an NIU	7-21
Configuring the RIO Rack.....	7-22
Load/Store/Verify RIO Configuration	7-22
Communications Setup.....	7-22
Storing RIO Configuration	7-23
Loading RIO Configuration.....	7-24
Verifying RIO Configuration.....	7-24
Clearing RIO Configuration	7-25
Ethernet Global Data Configuration.....	7-26
Configuring the Ethernet Interface Adapter Name (CPU364)	7-27
Setting Aliases for Remote Ethernet Interfaces (CPU364)	7-27
Name Resolution and Routing Table Configuration (CPU364).....	7-27
Defining EGD Exchanges.....	7-29
PLC Timing Considerations	7-30
Ethernet Global Data: Example 1	7-31
Ethernet Global Data: Example 2	7-32
Restoring EGD and Name Resolution.....	7-34
Advanced User Parameters for EGD (CPUE05)	7-34
Configuring VersaMax Nano and Micro PLCs.....	7-36
Rack/Module Operations	7-36
Counter, Pulse Width Modulation, and Pulse Train Output.....	7-37
PWM Frequency and Duty Cycle.....	7-37
Configuring Averaging Filter for Analog Input Potentiometers.....	7-37
Configuring Series 90 Micro PLCs.....	7-38
Rack/Module Operations	7-38

	Counter, Pulse Width Modulation, and Pulse Train Output.....	7-39
	PWM Frequency and Duty Cycle.....	7-39
	Configuring Averaging Filter for Analog Input Potentiometers.....	7-39
	Hardware Configuration Reference View.....	7-40
	Hardware Configuration Log View.....	7-41
	Hardware Configuration Power Consumption View.....	7-42
	Power Consumption Limit Calculations	7-42
	Components of the Power Consumption View.....	7-44
	Converting Rack Systems	7-45
	Printing Hardware Configuration.....	7-45
Chapter 8	Using Reference and Variable View Tables	8-1
	Variable View Tables – Overview.....	8-2
	Reference View Tables – Overview	8-3
	Customizing View Table Display	8-4
	Changing Reference View Table Display Format	8-5
	Customizing Variable View Table Display Format.....	8-6
	Creating New Reference and Variable View Tables.....	8-7
	Adding Elements to a View Table.....	8-8
	Adding an Element by Direct Entry to a VVT	8-8
	Valid VVT Variable Entries	8-8
	Adding an Address to a Reference View Table.....	8-9
	Valid RVT Entries.....	8-9
	Adding a Range to a Reference View Table.....	8-9
	Modifying Information in a View Table.....	8-10
	Editing Operations in View Tables.....	8-11
	Using cut, copy, paste in a VVT	8-11
	Details on Cutting and Copying.....	8-11
	Details on Pasting.....	8-12
	To drag and drop-cut in a VVT:.....	8-12
	To drag and drop-copy in a VVT:	8-12
	Details on Dragging and Dropping in a VVT	8-13
	Saving View Tables.....	8-13

Contents

	Online Viewing	8-14
	Details about Online Viewing.....	8-14
	To Toggle or Override a Reference in an RVT	8-14
	To Write a Value to a Reference in an RVT	8-15
Chapter 9	Motion Programming.....	9-1
	Setting Motion Program/Local Logic Editor Options	9-3
	Using the Motion Program Editor.....	9-4
	To Open the Motion Program Editor	9-4
	Creating Motion Program Logic	9-5
	Basic Requirements.....	9-5
	Using the Local Logic Editor	9-7
	To Open the Local Logic Editor	9-7
	Local Logic Commands.....	9-7
	Using the Local Logic Variable Table	9-8
	To open the Local Logic Variable Table.....	9-8
	Information Provided by the Local Logic Variable Table	9-9
	Saving Motion/Local Logic Programs	9-11
	Printing Motion/Local Logic Programs.....	9-11
	Storing Motion Programs and Subroutines to the PLC	9-11
	Restoring Motion and Local Logic Blocks	9-12
	Using the Cam Editor.....	9-14
	Installing the Cam Editor.....	9-14
	Starting the Cam Editor.....	9-14
	Adding a Cam Block to the VersaPro Folder	9-16
	Opening an Existing Cam Block.....	9-16
	Deleting a Cam Block	9-16
	Duplicating a Cam Block	9-16
	Viewing and Editing Cam Block Properties.....	9-17
	Renaming a Cam Block.....	9-17
	Using Cam Profiles in a Motion Program	9-17
Chapter 10	Communicating with the PLC	10-1

Connecting to a PLC	10-2
Direct Serial Port Connection	10-2
Multidrop and Modem Connections	10-3
Configuring Your Device and PLC CPU.....	10-3
Connecting to the PLC	10-4
TCP/IP Ethernet Connection	10-5
Configuring Your PC and PLC Hardware.....	10-5
Connecting to the PLC	10-7
Guidelines for Communications Configuration.....	10-8
Opening the CCU.....	10-8
Serial Parameter Settings.....	10-8
Modem Issues	10-9
Transferring Folders	10-10
Storing a Folder to the PLC 	10-10
Word for Word Changes in LD.....	10-11
Loading a folder to Your Computer 	10-12
Clearing the PLC.....	10-13
Verifying Folder Data	10-14
Reading/Writing/Verifying Flash Memory	10-15
Reading/Writing/Verifying the EZ Program Store Device.....	10-16
Viewing PLC Status Information	10-17
Placing the PLC in Run or Stop Mode	10-19
Monitoring Logic Execution	10-20
Turning Monitoring On and Off	10-20
Changing the Display Format of Monitored Logic	10-21
Update in progress or unavailable - Press F1 for Help.....	10-21
Searching for Overrides.....	10-22
Chapter 11 Working with Fault Tables	11-1
Working with the PLC and I/O Fault Tables.....	11-2
Viewing the PLC and I/O Fault Tables	11-2
Viewing Fault Details.....	11-3
Sorting Faults.....	11-4

Contents

Saving Fault Information.....	11-4
Clearing the Fault Table	11-5
Opening Other Fault Tables.....	11-5
Changing Fonts	11-6
Printing Fault Tables	11-6
Appendix A VersaPro Menus and Toolbars	A-1
VersaPro Menus.....	A-1
File Menu.....	A-1
Edit Menu	A-2
View Menu	A-3
Insert Menu	A-3
Folder Menu.....	A-4
PLC Menu.....	A-5
Tools Menu	A-6
Window Menu.....	A-6
Help Menu	A-6
VersaPro Toolbars	A-7
Standard toolbar	A-7
Ladder toolbar.....	A-8
View toolbar	A-9
Folder toolbar.....	A-9
PLC toolbar.....	A-10
Function toolbar	A-10
HWC Menus.....	A-11
File Menu.....	A-11
Edit Menu	A-12
Edit menu, Expansion Rack System Sub-menu	A-12
Edit menu, Expansion Receiver Sub-menu.....	A-13
Edit menu, Rack Operations Sub-menu.....	A-13
Edit menu, Module Operations Sub-menu.....	A-14
Parameter Menu	A-14
View Menu	A-14
View Menu, Parameter Edit Sub-menu	A-15

Tools Menu	A-15
Window Menu.....	A-16
Help Menu	A-16
HWC Toolbar.....	A-17
Appendix B Serial Connections.....	B-1
Serial Port and Cables.....	B-2
RS-422 Interface	B-2
Cable and Connector Specifications.....	B-3
PLC Serial Port	B-4
IBM-AT/XT Serial Port	B-5
RS-232/RS-485 Converter.....	B-5
Serial Cable Diagrams	B-6
RS-232 Point-to-Point Connection.....	B-6
Multidrop Connections.....	B-7
Miniconverter Kit.....	B-8
Description of Miniconverter.....	B-8
Pin Assignments, RS-232 Port.....	B-9
Pin Assignments, RS-422 Port.....	B-9
System Configurations	B-10
Appendix C VersaPro License Transfer Procedure	C-1
Appendix D Using the VersaPro Keyboard	D-1

Welcome to VersaPro

Welcome to VersaPro™, GE Fanuc's Windows®-based programming software for the Series 90™-30 and VersaMax™ PLCs. VersaPro is designed to install and run under Windows 95, Windows 98, and Windows NT® 4.0, and Windows 2000.

With VersaPro, you can:

Create PLC logic and information associated with that logic in a folder

- Configure PLC Hardware
- Create and edit variables
- Create, edit, and monitor the execution of Ladder or Instruction List logic
- Create Motion, Local Logic and Cam programs for the 90-30 DSM314 Motion module

Chapter Contents

- Overview of the VersaPro Programming Software components
- The Workbench Window
- Configuring Workbench Options (setting editor and target hardware)

Installing VersaPro Software

Note: VersaPro must be installed on a hard drive in your computer. *Do not* attempt to install VersaPro on removable media such as Jaz® or Zip® drives.

1. It is recommended that you close all applications including virus checking, Internet Explorer, and CIMPPLICITY HMI software that might be running in the background. You may need to check the task manager to determine if other applications are running.
2. Put the VersaPro CD in the CD-ROM Drive.
3. Select the CD drive from Windows Explorer.
4. Double click Setup.exe
5. Follow the user prompts to complete the installation. If you have a previous version of VersaPro installed, the installation tool will first uninstall the previous version. During this uninstall process, you may be asked whether you would like remove shared files. It is recommended that you always answer “No to All” to ensure that no files are deleted that might be needed by another application.

Note: When you upgrade from VersaPro Version 1.0x or VersaPro 1.1x to 1.50, your user screen settings and the directory location for program files will be lost. You will need to re-establish these settings after completing the upgrade.

Note: For procedures to transfer your VersaPro license to another computer, refer to Appendix C.

Starting VersaPro Software









The VersaPro application is installed in the GE Fanuc Software Program group. The application can be started by selecting Start->Programs->GE Fanuc Software->VersaPro. It is also possible to create a shortcut to the VersaPro application and place the shortcut on the desktop, or to click on a file created by VersaPro (the file in the VersaPro folder with a .fld extension), and start the application in the context of the selected folder. VersaPro may also be started using CTRL-ALT-V.

Multiple Instances of VersaPro

- If you are using a serial connection, only one instance of VersaPro can be connected to the PLC. You can have multiple offline (not connected to the PLC) instances.
- If you are connecting to the PLC via Ethernet, you can have only one instance of VersaPro.

Using VersaPro – Overview

VersaPro provides a single programming interface to configure your PLC hardware, create and edit PLC logic, and monitor the execution of the PLC program.

Component	Description
 Folder Browser	Displays a tree-like structure that provides an overview of the current folder
 Hardware Configuration	VersaPro's default hardware platform is the VersaMax PLC. You can change the hardware platform to create programs and hardware configuration for all Series 90-30, VersaMax, and Series 90 Micro PLCs.
 Logic Editors	There are two editors for creating PLC logic: the Instruction List Editor and the Ladder Diagram Editor. You can convert programs and blocks from IL to RLD.
 Motion Editors	A Motion editor and a Local Logic editor are provided for creating local logic and Motion programs for the Motion Mate DSM314 motion control module. A Cam editor has been added to VersaPro 1.5. If the Cam editor is installed, it can also be used with DSM314 release 2.0.
 Syntax Checking	VersaPro provides a tool to check that your program is syntactically valid before storing to the PLC.
 PLC Communications	VersaPro supports serial and Ethernet connections to the Series 90-30 and VersaMax PLCs.
 Online Monitoring	Online monitoring and control is supported in logic editors and Reference View Tables and Variable View Tables.
 Fault System	The fault system provides quick connection to view PLC and I/O fault tables in the PLC.
 Information Window	The Information window displays the results of actions performed in VersaPro.

The following abbreviations are used in VersaPro:

Abbreviation	Component
IL	Instruction List
RLD	Relay Ladder Diagram
RVT	Reference View Table
VDT	Variable Declaration Table
VVT	Variable View Table
LL	Local Logic
LLVT	Local Logic Variable Table

The Workbench Window

When you first start VersaPro, the workbench is displayed. You can perform the following tasks from the workbench:

- Create and Open Folders
- Backup and Restore VersaPro folders
- Setup communications parameters, Connect to the PLC and view Fault Tables
- Customize Workbench Options

Setting Workbench Options

VersaPro allows you to customize editor and window options. It is important to confirm the default language and hardware configuration before creating a new folder. Other options may be customized before opening a folder, or after the folder is opened.

General Options

VersaPro's default hardware configuration is the VersaMax PLC. The default block language is Ladder Diagram. To change the default configuration so that you can create programs and hardware configuration for the target devices, or to customize display and editing options, select the Tools menu and choose Options. The Options dialog box will appear.

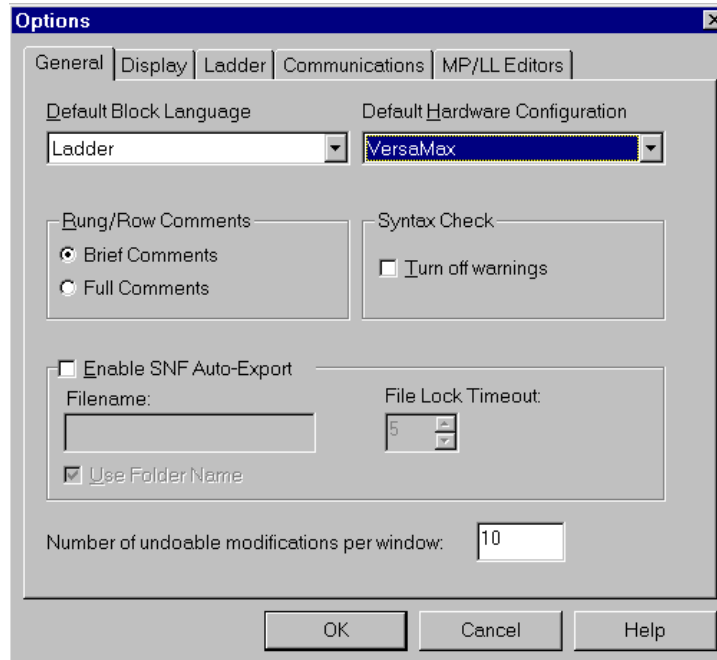

-
- **Setting Block Language:** The default language is Ladder Diagram. To change the default block language to Instruction List, select the General tab. Click the Default Block Language and select Instruction List
 - **Changing Hardware Configuration default:** VersaPro's default hardware platform is the VersaMax PLC. You can create programs and hardware configuration for all Series 90-30, VersaMax, VersaMax Nano/Micro, and Series 90 Micro PLCs. To change the default hardware configuration, select the General tab and set the Default Hardware Configuration field.
 - **Setting Full or Brief comments:** In the LD and IL Editors, comments can be configured to be viewed in full or brief mode. The default is to view comments in brief mode. To change the default, select the General Tab and check the Full Comments button.
 - **Setting Syntax Check (Turn off Warnings):** By default, when VersaPro performs syntax checking on logic, multiple coil usage warnings are displayed in the information window. To suppress the warnings, select the General tab and check the Turn Off Warnings box.
 - **Enable SNF Auto-Export:** This option causes variables to be automatically exported in SNF format when you create or edit variables and then save the VDT. Only variables in the VDT with the EXT checkbox selected will be auto-exported. The .snf file will be exported to the current folder; any existing .snf file with the same name will be overwritten.
 - **Setting the number of undoable actions:** VersaPro allows you to configure the number of undo/redo operations available during editing sessions. The default number is 10. The valid range is 1 to 100.
 - **Filename:** If Use Folder Name is not selected, a filename is required. This name follows the same naming rules as VersaPro folder names.
 - **Use Folder Name (default):** If this box is checked, the exported filename will be *foldername.snf*.
 - **File Lock Timeout:** A *.lck (lock) file is generated at the same time as the *.snf file. The *.lck file is used to prevent reading or writing of the *.snf file while it is in use. VersaPro will attempt to access the *.lck file for the number of seconds specified in this field. Valid values are from 1 to 60 seconds.

Setting Display Options

VersaPro allows you to set text font, size and color separately for the IL, LD, Local Logic, and Motion Editors, for the VDT, and for Variable View, Reference View, and Local Logic Variable tables.

Perform these steps to set display options:

1. Choose Options from the Tools menu, or from the LD or IL Editor context sensitive menu (CSM).
2. The Options dialog box appears.
3. Select the Display tab.

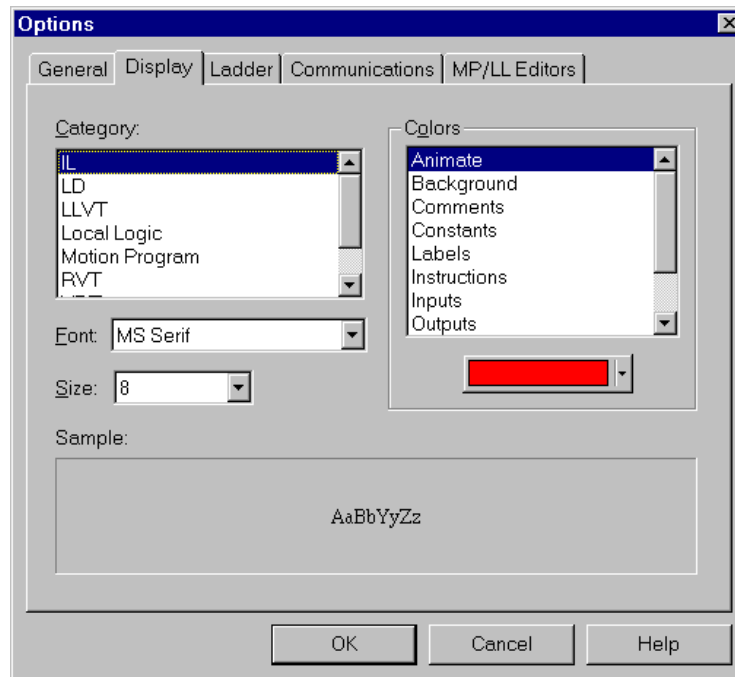

4. From the Category list, select the editor or table whose display options you wish to configure.
5. The Colors list displays the items you can configure for the selected editor or table.
6. Select the color to be used for each configurable area of the selected editor or table. The list of configurable areas differs based on the window whose display you are configuring.

Note: Certain combinations of colors and backgrounds can be difficult to read.

7. Select the font name and font size to be used to display text in the selected editor or table. Click OK

Note: You cannot change the font used for Column and Row headings.

The selected colors are applied to selected areas of the selected editor or table. The selected font is applied to all text within the selected editor or table. If the selected editor or table is visible, it appears with its changed colors, font and size.

Note: Selected fonts are used when you print your program.

Setting Communications Options

You can configure VersaPro to connect to a particular device immediately upon startup and to open the folder associated with that PLC.

To configure Autoconnect

1. Choose Options from the Tools menu, or from the Editor CSM.
2. The Options dialog box appears.
3. Select the Communications tab.

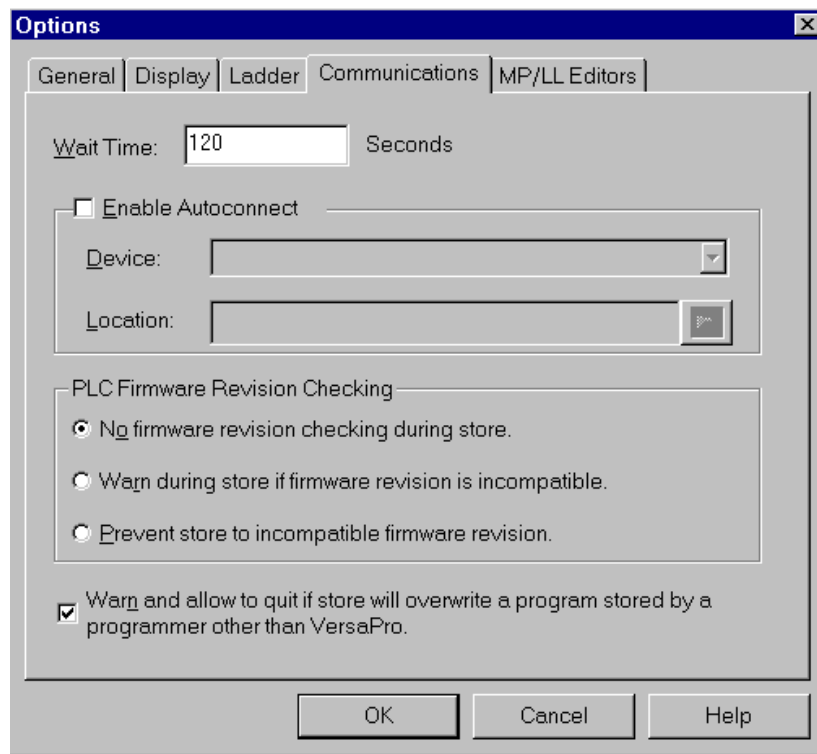

Note: The Wait Time parameter on the Communications tab has no effect on the operation of Autoconnect. The length of time that VersaPro tries to connect on startup is determined by the Connect Timeout parameter in the CCU. To set Connect Timeout, go to the Tools menu, and select Communications Setup. In the CCU, choose the Global Parameters tab.

4. Click the Enable Autoconnect checkbox.
5. In the Device field, select the Device to which you wish to connect automatically upon startup.
6. In the Location field, enter the starting search path for the folder associated with this PLC, or click the Browse for Folder button  and select the location from the Browse for Folder dialog box. This specifies the location where VersaPro will start to search for the VersaPor folder that is stored in the PLC.

VersaPro uses the PLC Folder Nickname (PLC program name) to determine what folder to open. By default, the Nickname is the last seven characters on the folder name. The Nickname may be viewed and set in the Folder Properties dialog box. (Choose Properties from the Edit menu or the folder root node CSM.)

7. Click OK.

Note: To turn off Autoconnect, select the Communications tab in the Options dialog and uncheck the Enable Autoconnect button.

Setting Ladder Options

VersaPro allows you to specify the types of information displayed about LD Editor symbols, and the width of LD Editor grid cells. You can also zoom in or out in order to proportionally enlarge or decrease the display size information in cells.

To specify the types of information displayed about LD Editor symbols:

1. Choose Options from the Tools menu, or from the LD Editor CSM. The Options dialog box appears.
2. Select the Ladder tab.

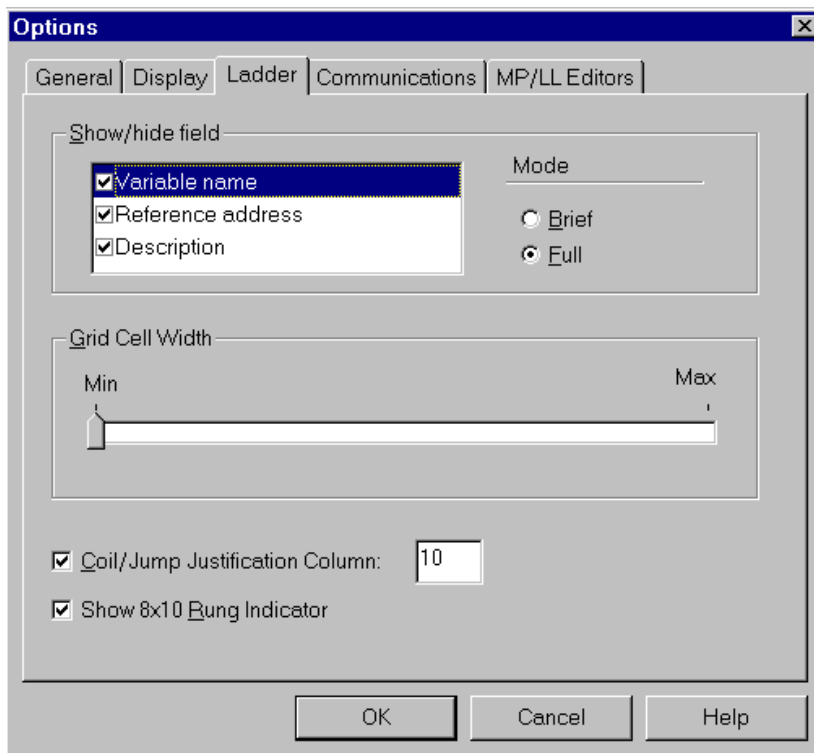

3. Choose whether to show or hide the variable name, reference address, and description. Each of the checked items appears in the LD Editor.
4. Determine whether variable names and descriptions should be displayed in part or full by selecting Brief or Full for each.
5. The variable description and/or reference address display in the bottom portion of each cell according to the current cell width. Text that exceeds the available space is replaced with "..."

To set LD Editor grid cell width:

VersaPro allows you to change the width of LD Editor grid cells, to make more text visible. Only the width of the cells changes: cell height and font size remain unchanged.

1. Choose Options from the Tools menu, or from the LD Editor CSM. The Options dialog box appears.
2. Select the Ladder tab.
3. Under Grid Cell Width, drag the slider to the right to increase the grid cell size, or to the left to decrease the size.
4. Click OK. The LD Editor grid changes to the new size.

Setting Motion Program/Local Logic Editor Options

1. Choose Options from the Tools menu, or from the Editor CSM. The Options dialog box appears.
2. Select the MP/LL Editors Tab.

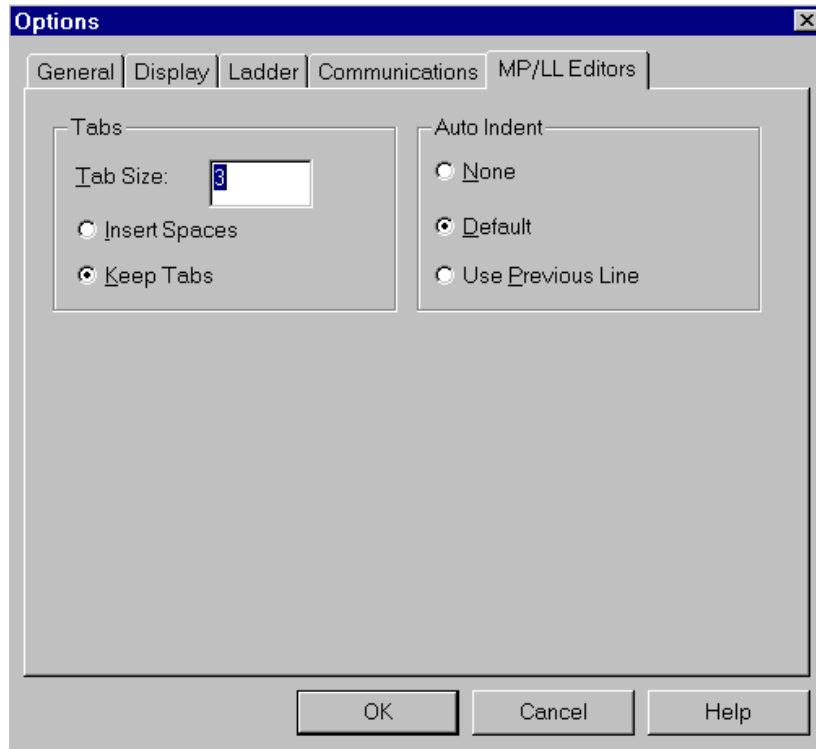

Tab Size	Sets the number of spaces that is equal to one tab. Valid values are integers 1 to 64.
Insert Spaces	Converts the tabs to the number of spaces specified in Tab Size.
Keep Tabs	Saves the tabs as tab characters.
None	No automatic indenting of code.
Default	Indent code using the Tab Size. The indent is based on the scope words.
Use Previous Line	Indents the current line the same as the line directly above it.

3. Select the tab and auto-indent options you want.
4. Click OK.

Chapter 2

Working With Folders

A folder contains all of the components required to program, configure and monitor your Series 90-30, VersaMax, VersaMax Nano/Micro, and Series 90 Micro PLCs. The components include Hardware Configuration, Variable Declaration Table, View Tables and program blocks. You can also insert other windows-components into the folder, like user documents and spreadsheets.

VersaPro allows you to have only one folder open at a time. However, you can have multiple instances of VersaPro running on your PC.

Chapter Contents

This chapter describes how to create and manage folders using the VersaPro software.

- Creating a New Folder
 - Creating an empty folder
 - Creating a folder, based on an existing VersaPro folder
 - Creating a new folder – importing logic from a Logicmaster 90 folder
 - Creating a new folder – importing logic from Control
- Working with existing folders (opening, saving, closing, deleting)
- Overview of the folder browser view
- Backing up and Restoring folders
- Protecting folders
- Changing folder properties
- Inserting blocks and objects
- Printing folder logic

Creating and Opening VersaPro Folders

Creating a New Folder

VersaPro provides several options when creating a new folder. You can create an empty folder, or create a new folder based on an existing VersaPro folder. VersaPro also provides an option for you to create a folder by importing content from Logicmaster 90 (Series 90-30 or Series 90 Micro folders) or Control (Series 90-30 or VersaMax folders).

To create a new, empty folder:

The default language for new folders is Ladder Diagram. The default hardware configuration is VersaMax. If you want to change the default language or target hardware for your new folder, select the Tools menu and choose Options. Change the settings in the Options dialog box.

To create a new, empty folder from the VersaPro workbench:

1. Click the New Folder button , choose New Folder from the File menu, or press Ctrl+N. The New Folder Wizard will appear.

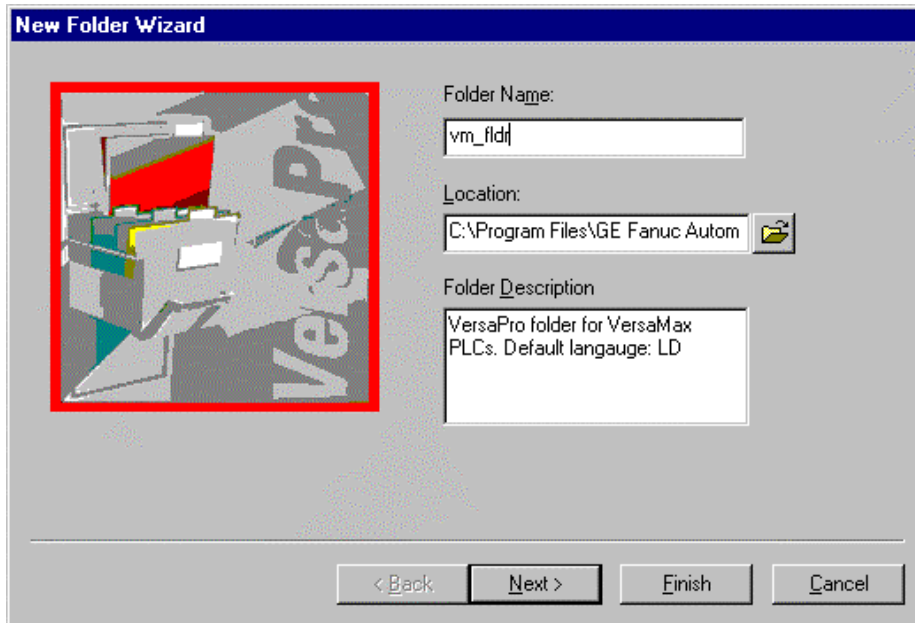

- In the Folder Name field, type a name for the new folder. A folder name is required. (See "Rules for Folder Names and Nicknames" on page 2-10.)
 - If you want to save the new folder to a location different from the default, click on the Browse button opposite the Location field.
 - Enter a folder description in the Folder Description field. You may enter up to 64 characters. This field is optional.
2. Click the Next button. The next screen of the New Folder Wizard will appear.

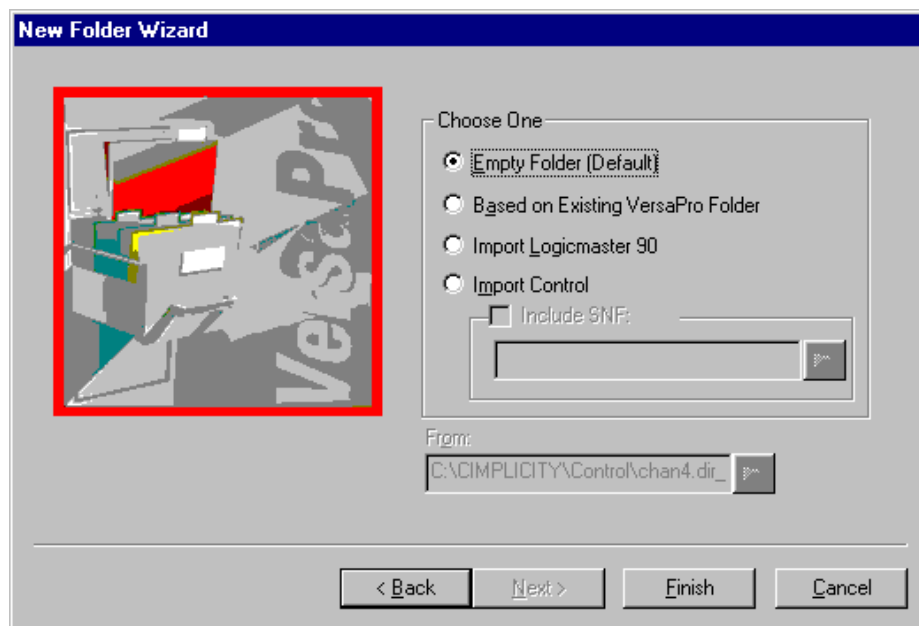

3. The Empty Folder (Default) button is automatically selected. Click Finish to create the new, empty folder.

The Folder Browser appears, displaying the new folder. The `_MAIN` block will appear in the default language's editor.

To create a new folder based on an existing VersaPro folder:

To create a new folder based on an existing VersaPro folder, launch VersaPro and perform the following steps:

1. Click the New Folder button , choose New Folder from the File menu, or press Ctrl+N. The New Folder Wizard will appear.

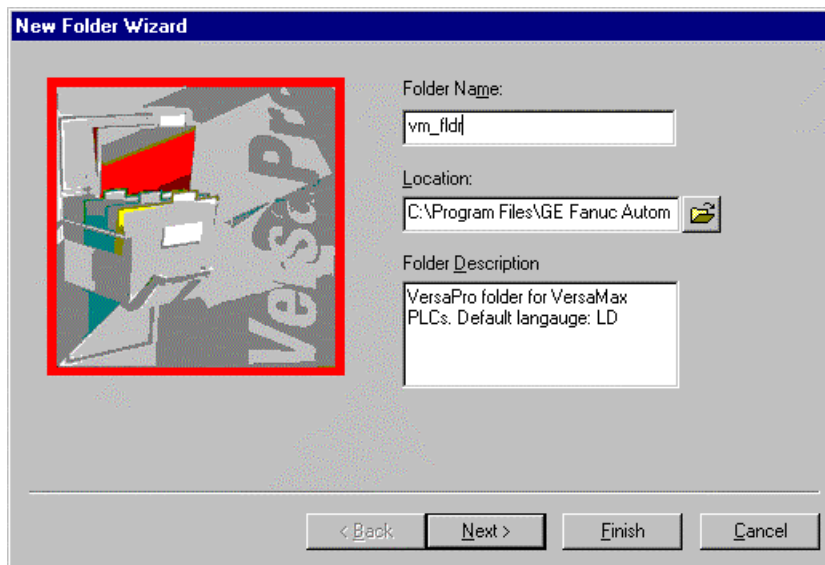

- In the Folder Name field, type a name for the new folder. A folder name is required.
 - If you want to save the new folder to a location different from the default, click on the Browse button opposite the Location field.
 - Enter a folder description in the Folder Description field. You may enter up to 64 characters. This field is optional.
2. Click the Next button. The next screen of the New Folder Wizard will appear.

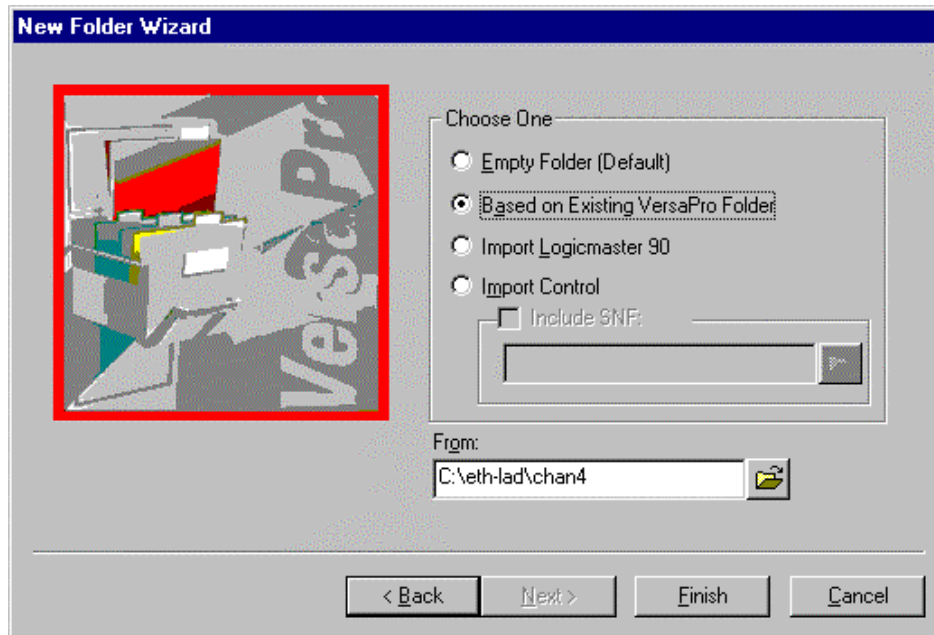

3. Click the Based on Existing VersaPro Folder button, then click the Browse button for the From field and, in the Browse dialog box that appears, locate the VersaPro folder upon which you wish to base this new folder.
4. Click Finish. The existing folder's structure and contents (blocks, VDT, etc) are duplicated in the new folder.

The Folder Browser appears, displaying the new folder. The _MAIN block will appear.

To create a new folder, importing a Logicmaster 90 Folder:

You can import Logicmaster folders configured for Series 90-30 or Series 90 Micro PLCs.

To create a new folder based on an existing Logicmaster 90 folder, start VersaPro and perform the following steps:

1. Click the New Folder button , choose New Folder from the File menu, or press Ctrl+N. The New Folder Wizard will appear.

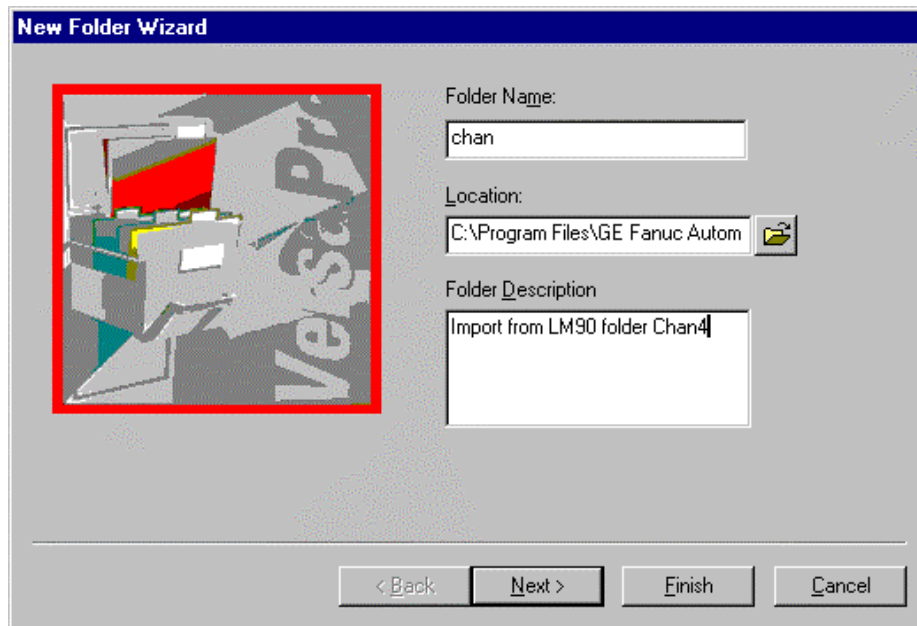

- In the Folder Name field, type a name for the new folder. A folder name is required.
- If you want to save the new folder to a location different from the default, click on the Browse button opposite the Location field.
- Enter a folder description in the Folder Description field. You may enter up to 64 characters. This field is optional.

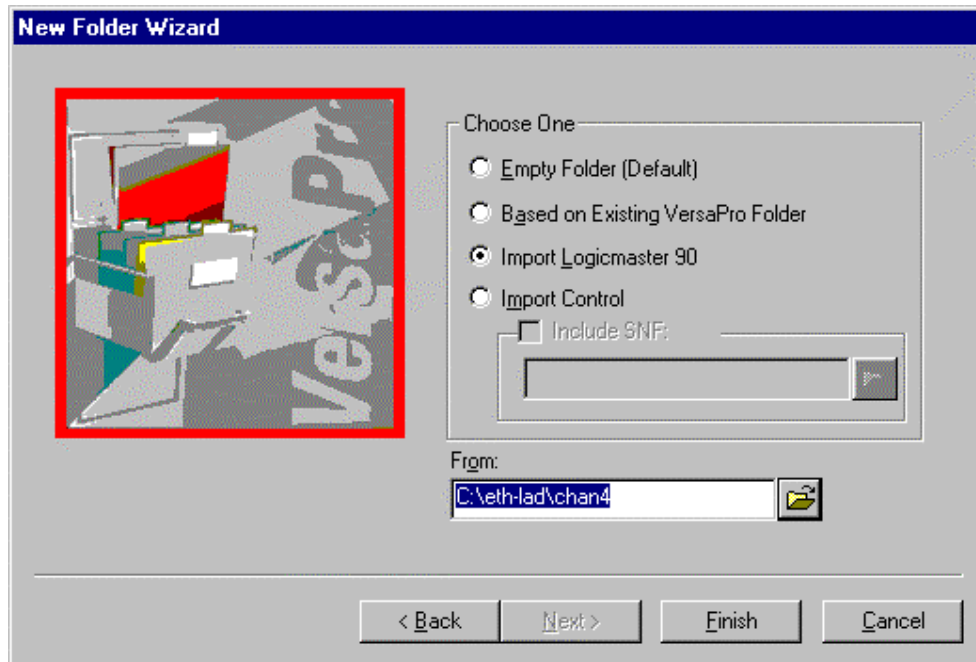

2. Click the Next button. The next screen of the New Folder Wizard will appear.
3. Click the Import Logicmaster 90 button, then click the Browse button for the From field and, in the Browse dialog box that appears, locate the Logicmaster 90 folder upon which you wish to base this new folder.
4. Click Finish. The content of the Logicmaster 90 folder is imported into the new folder. The logic is checked for correct syntax.
5. If any syntax errors are found, they are reported in the Information Window, and the process is aborted. The new folder is not created.
 - If no syntax errors are found, the folder is populated with the logic and hardware configuration from the Logicmaster 90 folder.

When a folder contains a locked block

You may import a Logicmaster 90 folder or load a folder from a PLC containing a locked (protected) block. The following will occur:

- When a folder containing a locked block is imported from Logicmaster 90 or Control, the block name, type and language are retained, but the block contains no contents.
- When a protected block is loaded from a PLC, an empty block is created.

The Folder Browser displays an icon for the block.

To create a new folder, importing logic from a Control folder:

You can import VersaMax (.F2K) and Series 90-30 (.F3X) folders from Control.

To create a new folder based on an existing Control folder, launch VersaPro and perform the following steps:

1. Click the New Folder button , choose New Folder from the File menu, or press Ctrl+N. The New Folder Wizard will appear.

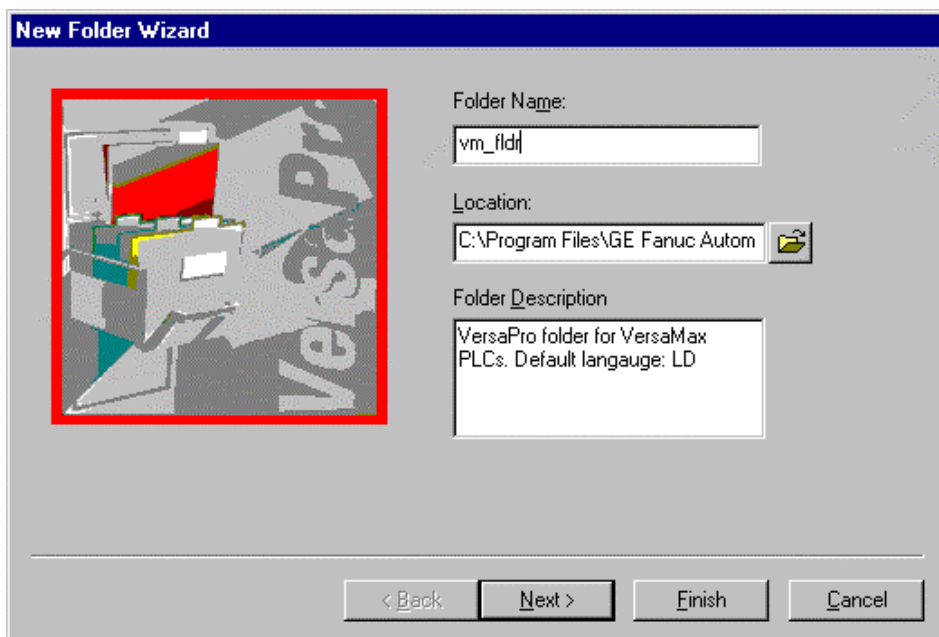

- In the Folder Name field, type a name for the new folder. A folder name is required.
- If you want to save the new folder to a location different from the default, click on the Browse button opposite the Location field.
- Enter a folder description in the Folder Description field. You may enter up to 64 characters. This field is optional.

- Click the Next button. The next screen of the New Folder Wizard will appear.

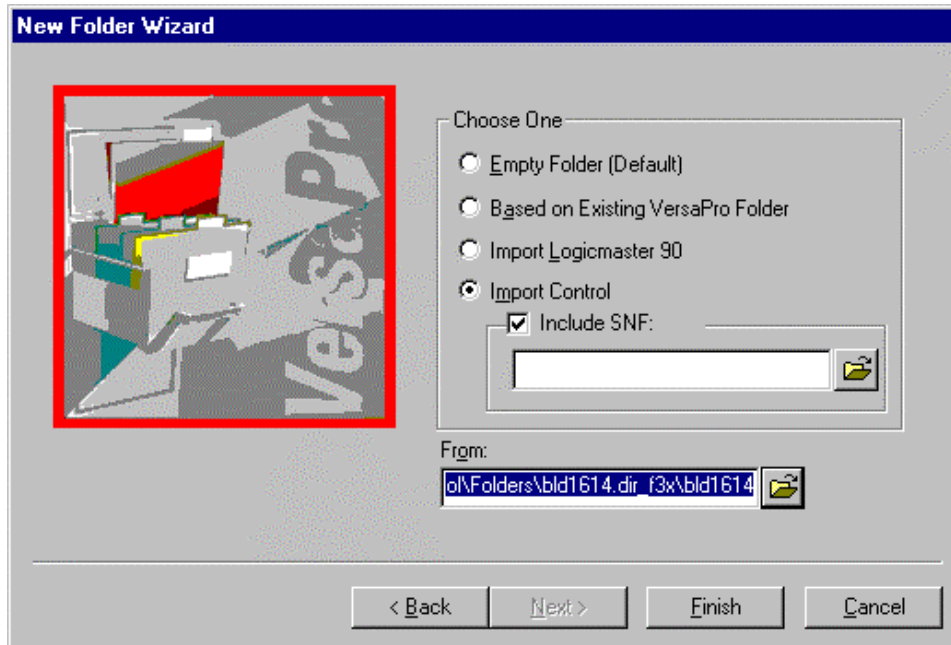

- Click the Import Control button, then click the Browse button of the From field and, in the Browse dialog box that appears, locate the Control folder upon which you wish to base this new folder.

Note: Only Control folders with .f3x and .f2k extensions may be imported.

Note: Your Control folder must be successfully built in Control before importing, and the hardware configuration must also have been built in Control.

- If you are importing variables from Control, select the Include SNF checkbox, then click the Browse button and, in the Browse dialog box that appears, locate the SNF file that is associated with the Control file to be imported. (This field is optional.)

Note: When importing a Control folder, in order to add variable nicknames, the SNF (shared name format) file associated with the folder to be imported must first be exported from the Control folder using Control. Refer to the Control online help for details on exporting an SNF file.

5. Click Finish. The content of the Control folder is imported into the new folder. The logic is checked for correct syntax.
 - If syntax errors are found, they are reported in the Information Window, and the process is aborted. The new folder is not created.
 - If no syntax errors are found, the folder is populated with the logic and hardware configuration from the Control folder.

Rules for Folder Names and Nickname

This section describes naming conventions and rules for new folders and folder nicknames.

Rules for Folder Names

The following rules apply to folder names for new VersaPro folders:

- A folder name may be no longer than 103 characters.
- The following characters may not be used in a folder name: . (period), \ (backslash), / (forward slash), : (colon), * (asterisk), ? (question mark), < (less than), > (greater than), | (vertical bar), " (quotation mark).

Rules for Folder Nicknames

The Folder Nickname (or Program Name) is the name used when storing the folder to the PLC. Both the Series 90-30 and VersaMax PLCs will recognize a nickname that is 7 characters or less.

- A nickname must be 7 characters or less.
- The first character of a nickname must be a letter.
- The remaining characters may be letters, digits, or the underscore character ("_").
- An underscore may not appear directly after an underscore.
- When a folder is created, the Folder Nickname defaults to the last 7 characters of the folder name.

Directory structure and files for a new folder

When a new empty folder is created, the following files are created at the folder's specified location. For these examples, the folder's name is *newfolder*.

- *_MAIN.blk* (the *_MAIN* block)
- *newfolder.fld* (a description of the folder's contents)
- *newfolder.vdt* (the Variable Declaration Table)
- *newfolder.hwcfg* (Hardware Configurations)
- *newfolder.ssx* (Smart Store Extensions)

For a new folder created based on an LM90 import named, for example, *LM90impt*, the folder is created at the specified location including these files:

- *_MAIN.blk* (the *_MAIN* block)
- a *.blk* file for each LM90 block
- *LM90impt.fld* (a description of the folder's contents)
- *LM90impt.vdt* (the Variable Declaration Table)
- *newfolder.hwcfg* (Hardware Configurations)
- *newfolder.ssx* (Smart Store Extensions)

Opening an Existing Folder

VersaPro allows you to open a folder from a local drive or diskette, or from a network drive. Perform the following steps to open an existing VersaPro folder.

1. From the File menu, choose Open Folder, or on the toolbar, click the Open Folder button.  button.
2. If another folder is already open, a dialog box appears, asking if you wish to close the open folder.
3. Once you have closed the open folder, an Open dialog box appears. Folders have file type *.fld*, so you will see *"*.fld"* in the "Files of type:" list.
4. Select the drive and folder to open.
5. Click the Open button.
6. The folder opens. Its components are displayed according to the properties retained upon the last Save.

Using the Folder Browser

After creating a new VersaPro folder or opening an existing folder, the Folder Browser appears, along with the default windows (logic editor, information window, etc.).

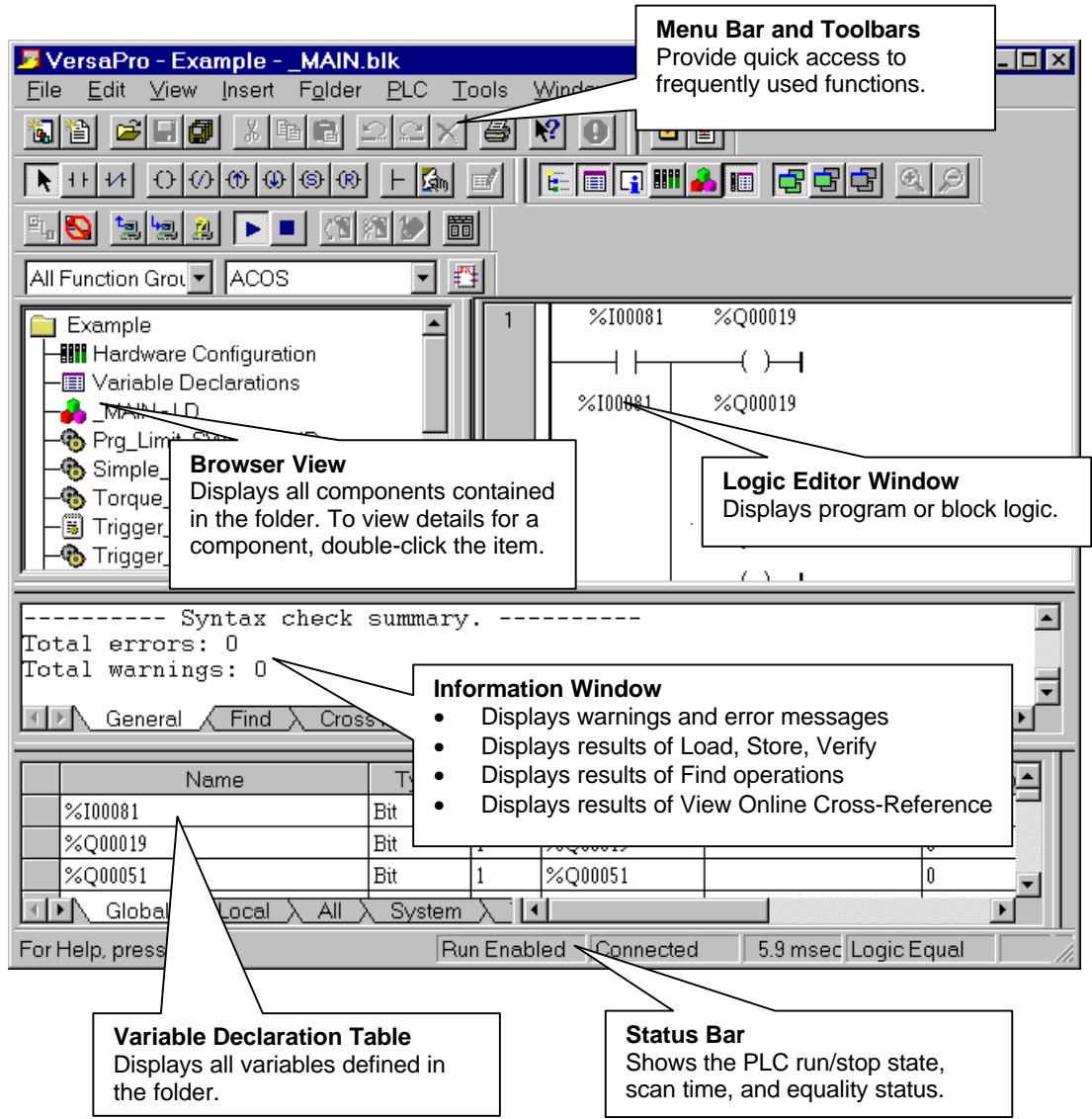

The Folder Browser displays a tree-like structure, showing all of the components associated with the folder. The display includes a list of all blocks included in the folder (including _MAIN block), as well as icons providing access to Hardware Configuration, the Variable Declaration Table and View Tables.

The Folder Browser allows you to navigate through the current folder easily and to create, arrange, modify or delete blocks and block properties. It also allows you to check the syntax of blocks within a folder.

To open an item in the browser window, double-click the item in the browser.

Information Window

The General tab displays error and warning messages (for example, the results of checking logic for syntax errors). It also displays the details of searches, replacements, conversions from one language to another, and the results of the Find Unused Variables command (from the Folder menu, select Find Unused Variables).

The Find tab displays the results of the Find in Blocks operation. (Select Find in Blocks from the Edit menu or the Folder Browser CSM.) Lists block, rung, and instruction where each instance of the item being searched for was found.

The Cross Reference tab lists all variables used in the selected block and identifies the rung and instruction each variable is used in. To display the Cross Reference, select View Online Cross Reference from the Tools menu or the Folder Browser CSM.

Note: When the Information Window is resized to a larger window, the scroll box becomes too large to be moved in the scroll bar. To scroll the window, use the arrow buttons at the top and bottom of the scroll bar.

Context-sensitive Menu

The context-sensitive menu (CSM) is not on the menu bar. It appears when you click the secondary (right) mouse button in certain VersaPro windows or on certain elements. The menu contains a list of frequently-used options appropriate to the given context.

To use the CSM

1. Select a folder element (the folder or one of its sub-elements).
2. Click the secondary mouse button on the element.
3. A CSM similar to the one shown below appears. Unavailable options appear in gray text.
4. Click the desired option.

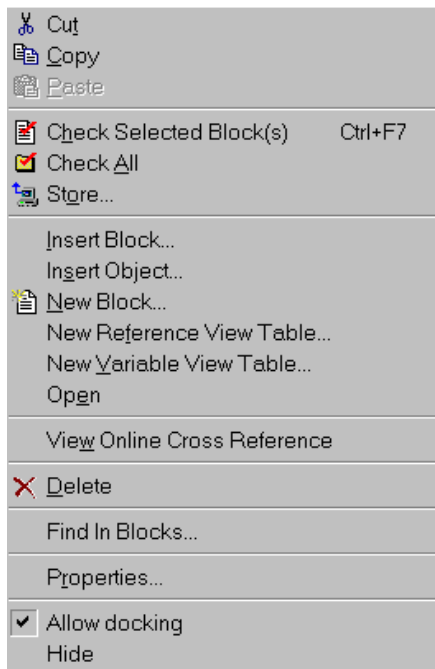

Working with Windows in the VersaPro Workspace

All windows in the VersaPro workspace can be moved by dragging and dropping and resized. To move a window, click its title bar or top border, if it doesn't have a title bar, and drag it. To resize a window, click its edge or corner and drag.

The Folder Browser, Information Window, Variable Declaration Table, and Local Logic Variable Table (used in Motion programs) can be docked (fixed) or undocked (floating). To select or deselect docking, click the secondary mouse button in the window and choose Allow Docking from the context-sensitive menu.

Note: If you click in an undocked window, you will not be able to select items from the main menus or other windows in VersaPro until the window is docked again. These windows can be docked and undocked by selecting Allow Docking from the CSM.

You should undock these windows only temporarily in order to move them to a new docked location.

Hiding a window makes it disappear temporarily. It does not cause the window's data to be saved. To hide a window, click the window's button on the View toolbar, or choose the window's name from the View menu. To hide a dockable window choose Hide from the CSM.

To display a window once it has been hidden, click the window's toolbar button, or from the View menu, choose the window's name.

Folder Operations

This section describes additional operations and functions which may be performed on VersaPro folders, including:

- Performing standard file operations (close, save, delete, backup, restore)
- Restricting access to VersaPro folders (enabling password protection)
- Editing folder properties

Closing a VersaPro Folder

Since only one folder can be open at a time in a single instance of VersaPro, an open folder must be closed before creating a new folder or opening an existing folder. When you try to open a folder when a folder is currently open in VersaPro, you will be prompted to save the currently-open folder before opening the new folder. You can also close a folder by performing the following steps:

1. Select the File menu and choose Close Folder. If any of the folder's components have changed, you will be prompted to save the changes for each component.
 - Click Yes to save changes or No to ignore changes. Clicking Cancel aborts the close operation.
2. The folder is closed. As part of the folder closing process, the Folder Browser is automatically saved, the size of the last active block is saved as the retentive block state, and the individual size and position of all dockable windows and all columns are saved as retentive states.

Saving a Folder

VersaPro allows you to save an open folder and folder contents to its current location. This operation saves the entire folder, not individual parts.

To save a folder, select the File menu and choose Save All. You can also click the Save folder button  on the toolbar. The open folder is saved.

The File, Save menu item saves only the selected component.

Deleting a Folder

To delete a VersaPro folder, locate the folder on your hard drive and use Windows Explorer to delete.

Backing Up and Restoring

VersaPro provides commands to back up a folder and to restore a folder from backup. VersaPro creates backup files with a .flb extension.

Backing Up a Folder

Backing up ensures that data is not lost in any event. It is recommended that you backup your folder occasionally to protect your program.

1. Select the Folder menu and choose Backup. The Backup Folder dialog box will appear.
2. In the Source Folder field, enter the path and name of the folder that you want to back up, or locate it by clicking on the Open Folder button and selecting the folder in the Browse dialog box that appears.
3. In the Destination field, enter the name of the backup and the location to which you wish to save it, or locate the path by clicking on the Open Folder button and selecting the folder in the Browse dialog box that appears.
4. Click OK. A backup of the folder you select is created and saved under the specified name to the indicated location.

Restoring a Folder from Backup

VersaPro allows you to restore backed up files as necessary. Compressed backup files are decompressed and fully restored when a restore is performed. Perform the following steps to restore a folder from backup.

1. Close any open folders.
2. Select the Folder menu and choose Restore. The Restore Folder dialog box will appear.
3. In the Source Folder field, enter the path and name of the folder that you want to restore, or locate it by clicking on the Open Folder button and selecting the folder in the Browse dialog box that appears.
4. In the Destination field, enter the location to which you wish to restore the folder, or locate the path by clicking on the Open Folder button and selecting it in the Browse dialog box that appears.
5. Click OK. The folder that you selected is restored to the location that you specified.

Restricting Folder Access

VersaPro allows you to restrict access to a folder by locking it. A locked folder's contents may be viewed but not changed. A folder may be locked with or without a password. If a folder is locked with a password, you must enter the password to unlock the folder. A locked folder is "read-only."

Locking a Folder

Perform the following steps to lock a folder:

1. Open the folder you want to lock.
2. From the Folder menu, select Lock. The Folder Security dialog box will appear.
 - To lock the folder without a password, click OK.
 - To lock the folder with password protection, check the Lock with Password checkbox. Enter the password in both the Enter Password and Verify Password fields. Note: The password is case sensitive.
 - A password must be eight characters or less.
 - Valid password characters are digits (0-9), uppercase (A-Z) and lowercase (a-z) letters, and the underscore (_).
3. Once the folder is successfully locked, the folder title bar will display READ_ONLY, indicating that the folder is protected. You cannot edit any portions of the folder, except for temporarily adding variables to existing view tables.

Note: Once a folder is locked with a password, that password cannot be changed. To assign a new password, unlock the folder, then lock it with a new password.

Operations permitted on locked folders

- Edit existing view tables. You may not create new view tables. Variables already defined in the Variable Declaration Table may be added to VVTs for the purposes of monitoring, but the changes cannot be saved. New variables may not be created in the VVT. Addresses may be added to RVTs, but cannot be saved.
- Open and close windows or blocks
- Rearrange windows
- Monitor logic execution
- Toggle and Override I/O

-
- Change variable values
 - Copy blocks and portions of logic from the folder
 - Create a new folder based on the locked folder. The new folder will also be locked, with the old folder's password.
 - Store and Verify folders

Unlocking a Folder

If a folder is `READ_ONLY`, you must unlock the folder to edit the folder. If passwords were used when locking the folder, they must be supplied to successfully unlock the folder. Perform the following steps to unlock a folder:

1. From the Folder menu, select Unlock.
2. If the folder has a password, the Enter password dialog box appears.
3. Type the password.
4. The phrase "READ ONLY" in the folder's title bar disappears.
5. The old password is cleared. The folder can now be edited.

Changing Properties

Folder properties are set when a folder is created. However, you can change the folder description and nickname. Perform the following steps to change folder properties:

1. Open the folder whose description or nickname you wish to change.
2. From the Edit menu, choose Properties, Folder. The Folder Properties dialog box will appear.
3. Change the description as desired. A description may be up to 64 characters long.
4. Change the nickname as desired. The nickname may be up to 7 characters
5. Click OK. The folder properties are saved, and the Properties dialog box closes.

Printing Your Program

Hardware Configuration is not included in any printed report. If you want to print out Hardware Configuration, you must do so using the Stand Alone Hardware Configuration utility.

Printing a Report

The Print Report dialog box allows you to define which components should be printed when you generate a report. You can print Blocks, a Cross Reference, a Table of Contents, a Header Page, and Variables. The Print dialog box allows you to choose printers, print ranges, and the number of copies that you want to print. The Page Setup dialog box allows you to select paper size, source, orientation, and margins.

Information about which Print Components, which Blocks and which details about blocks, whether or not a Table of Contents or a Header page, and whether Cross References and the associated Reference Addresses are to be included in printing, is retained after you generate your first report. You can change this information as desired, but you need not reset the specifications every time you print. All other settings require input each time a report is generated.

Perform the following steps to customize and print your program:

1. From the open folder, select the File menu and choose Print Report. The Print Report dialog box will appear. Use this dialog box to customize your listing as described below.

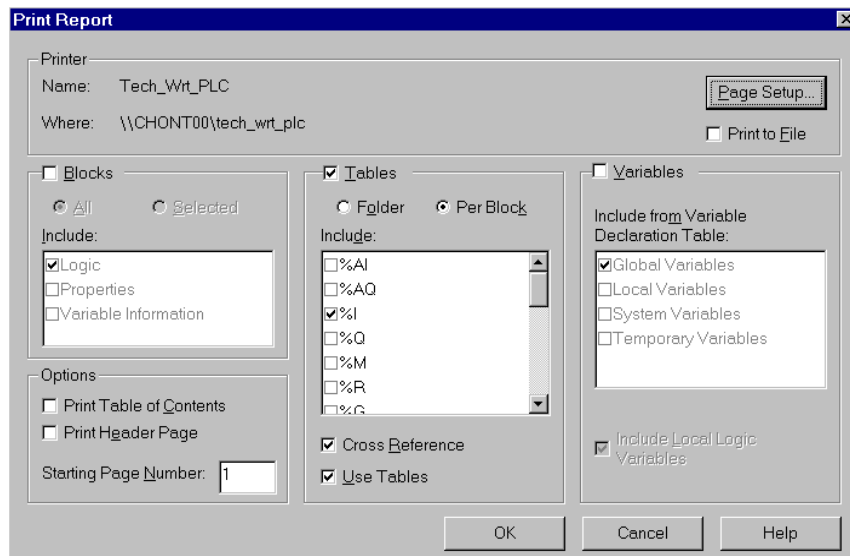

- To include Blocks in your report, click the Blocks checkbox.

Note: When multiple blocks are printed, they are printed in the order they appear in the Folder Browser.

In the Blocks group, check each block element that you want to include in the report. You can choose:

- Logic
- Properties
- Variable Information (all variables used in this block plus local variables, even if they are not used in the block)

Note: To activate the Selected radio button, you must first go to the folder browser and select the block or blocks that you want to print.

- To include a Cross Reference list in your report, click the Cross References checkbox, then choose whether you want to include Cross References for the entire folder, or per block by clicking the appropriate option button.
 - If you choose to print Cross References per block, and you want to include identifiers (Jump, Label Names, Calls, and MCR Names) check the Include Identifiers checkbox.

Note: The Cross Reference includes implicit addresses for all variables that use them. Implicit addresses are enclosed by brackets [].

- To include Variable Tables in your report, click the Variables checkbox, then select which variables you want to include by checking the appropriate checkboxes.
 - To include Local Logic variables, select the Include Local Logic Variables checkbox.
 - To select paper size, source, orientation, and margins, choose Page Setup from the File menu, or click the Page Setup button in the Print Report dialog. Click the OK button to save your specifications.
 - To print contents of the report, select Print Table of Contents.
 - To print Folder Properties information, select Print Header Page.
 - To change the starting page number for the report, type the number you want in the Starting Page Number box. Maximum is 9999. Default is 1.
2. Click the OK button or press Enter to print.

Printing Logic, Variable Declaration Table, or Information Window Contents

With the window you want to print selected, choose Print from the File menu, click the Print button , or press Ctrl + P. The Print dialog box appears.

1. In the Printer group, use the drop-down list to choose the printer that you want to use to print the report. You can also view or alter Printer Properties by clicking the Properties button, or choose to print to file by clicking in the Print to file checkbox.
2. In the Print range group, determine whether the current selection, a certain range of Rows, Rungs or Tabs, or All items should be printed in the report.
3. In the Copies group, determine the number of copies that you want to print by entering it manually or by using the arrow buttons to the right of the field.
4. Click OK to print, or Cancel to close the dialog box without printing.

Chapter 3

Working With Blocks

The Series 90-30 and VersaMax PLCs support multiple blocks per folder (the total number of blocks vary, depending on the PLC configured). All PLCs require that one of the blocks is `_MAIN`. This block is automatically created when you create a new folder.

This chapter describes how to work with blocks using VersaPro Programming Software.

Chapter Contents

- How to create and open blocks and objects
- How to manage blocks and related components in the folder browser
- How to work with variables associated with folder components.
- How to convert blocks between IL and LD

Creating, Inserting and Opening Blocks

VersaPro allows you to use multiple blocks per folder, one of which must always be a `_MAIN` block. A name is always required in order for a block to be created. Note that each PLC model has a different limit for the number of blocks, excluding `_MAIN`, that can be created in a folder. (Series 90 Micro supports only a `_MAIN` block.) More than one block can be open at once.

Once a block has been created, it can be called from within the `_MAIN` or any other block. You can also call a block that does not yet exist, but that you intend to create. When you compile, a syntax error appears, reminding you that the new block has not been defined.

The following types of blocks can be created in VersaPro:

Block Type	Supported by
Ladder Subroutine	All, except Series 90 Micro
Instruction List Subroutine	Series 90-30, VersaMax, VersaMax Nano/Micro
External (C Block)	Series 90-70 Series 90-30 models 350, 351, 352, 360, 363, and 364
Motion (Local Logic, Motion, and Cam programs)	Series 90-30 DSM314 motion module

Creating a Subroutine

1. With a folder open, choose New from the File or Context-Sensitive menu. From the Subroutine submenu, select Ladder or Instruction List. (You can also create a Ladder subroutine by clicking the New Block button on the toolbar. )

The Create New Ladder Diagram or Create New Instruction List dialog box appears.

2. On the Basic Properties tab, enter a unique name for the new block. Restrictions on name entries.

If you are creating a timed interrupt block for a 90-30 PLC, the block name must conform to the requirements for Timed Interrupt.

3. If you wish, enter a description for the block.
4. To assign Interrupt parameters to the block, select the Schedule tab. Double click under the Type column to select I/O Interrupt or Timed Interrupt. For details about the interrupt parameters, click the dialog box Help button.

Note: For a 90-30 timed interrupt block, the block name determines the time base, delay, and time interval parameters. If you change these values, an error message will appear when you try to close the dialog.

5. To place restrictions on editing or viewing the block, select the Lock tab.
6. Click OK. A new block is created.

If the Folder Browser is open and a block is selected, the block is added to the Folder Browser above the currently selected item. If the Folder Browser is closed, or the Folder node, Hardware Configuration, or VDT in the browser is selected, the block is added at the end of the browser.

Creating an External C Block

Note: The C executable file must be created using the C Programmer's Toolkit for Series 90 PLCs. Also, it must be created specifically for the target PLC (90-70 or high-end 90-30). 90-30 C blocks do not use input/output parameters.

1. With a folder open, choose New, External from the File or Context-Sensitive menu. The Create New C Block dialog box appears.
2. On the Basic Properties tab, enter a unique name for the new block. Restrictions on name entries.
3. If you wish, enter a description for the block. Restrictions on Descriptions..
4. To associate a C executable file (.exe) to the block, select the C Binary tab. To locate the C program that you want to use, click the browser button next to the Update Using field.
5. To assign Interrupt parameters to the block, select the Schedule tab. Double click under the Type column to select I/O Interrupt or Timed Interrupt. For details about the interrupt parameters, click the dialog box Help button. (A C block can have either Interrupt parameters or Input/Output parameters, not both.)
6. To assign Input/Output parameters to the block, select the Parameters tab. Up to seven parameter pairs can be assigned to an external C block for 90-70.
7. Click OK. A new block is created.

If the Folder Browser is open and a block is selected, the block is added to the Folder Browser above the currently selected item. If the Folder Browser is closed, or the Folder node, Hardware Configuration, or VDT in the browser is selected, the block is added at the end of the browser.

90-30 Timed Interrupt Block Name Requirements

For the 90-30 PLC, Timed Interrupt blocks are defined and named in the form "pTiiii" where p is the time base and iiii is the time interval.

If p is 1, iiii can range from 0001 to 0010 (with block names 1T0001 to 1T0010).

If p is 2, iiii must be 0001 (with block name 2T0001).

Examples:

Block Name	Time Base	Initial Delay	Time Interval
1T0005	.001 sec.	0	5 msec.
2T0001	.01 sec.	0	10 msec.

The Timed Interrupt block 1T0005 would be defined as follows: Time Base = .001 s; Initial Delay = 0; Time Interval = 5 (5 msec).

The Timed Interrupt block 2T0001 would be defined as follows: Time Base = .01 s; Initial Delay = 0; Time Interval = 1 (10 msec).

The Initial Delay for a 90-30 PLC Timed Interrupt block is always 0.

If a 90-30 PLC is declared in Hardware Configuration and the block is designated as a Timed Interrupt block, but the name does not match the naming specification, an error is reported when you click OK to close the Create new block dialog box.

Name Field Restrictions

- Only the characters A-Z, a-z, 0-9, and _ (no consecutive “_”s) are permitted.
- The block name must start with a letter or underscore. Series 90-30 Timed Interrupt Blocks follow different rules.
- A block cannot have the same name as another block that exists in the open folder. An error appears if you enter a repeated name.
- The block name can be no longer than seven characters.

Description Field Restrictions

- The description may be up to 64 characters.
- There is no restriction on the type of characters that can be used in a description.

Inserting a Block from Another Folder

You can copy blocks between folders using the Insert Block option. The name of the block you are inserting must be unique for the current folder. If the block you want to insert has the same name as an existing block, an error message will display.

When you add a block, the block's variables are added to the Variable Declaration Table.

Perform the following steps to insert a block from another folder.

1. Open the folder into which you wish to insert a block, and go to the Folder Browser.
2. Select the Insert menu and choose Block, or click the right mouse button and select Insert Block. The Insert Block dialog box will appear.
3. In the Look In box, navigate to the folder containing the block you want to insert.

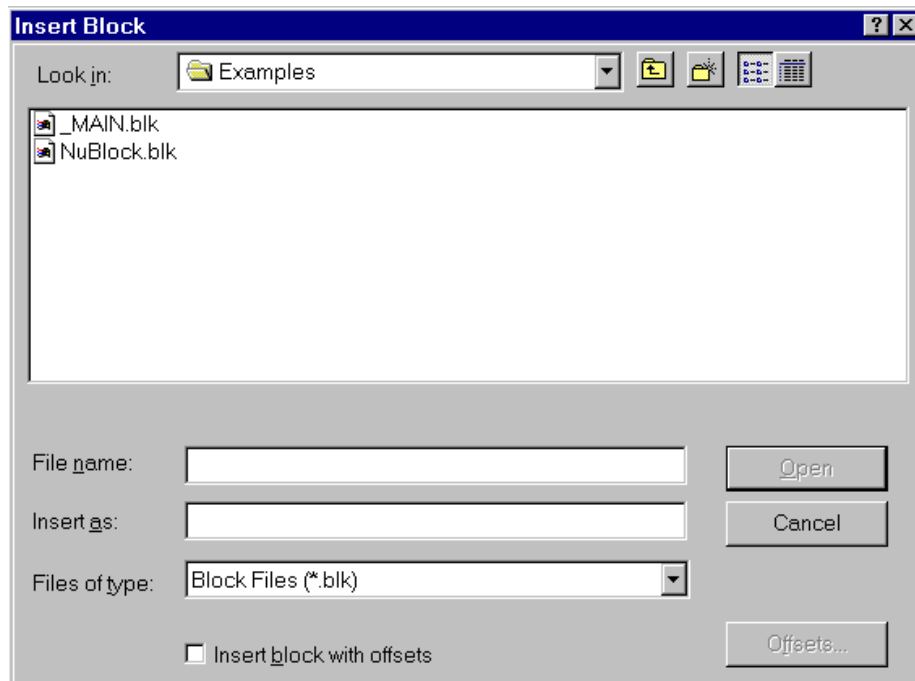

4. Select the block type:
 - *.blk for LD, IL, Local Logic, or Motion blocks
 - *.exe for C blocks
5. To change the name of the block, edit name in the Insert As box.
6. To define variable offsets for the block, or add a prefix or suffix to the variable names, select the Insert Block With Offsets checkbox, then click the Offsets button.

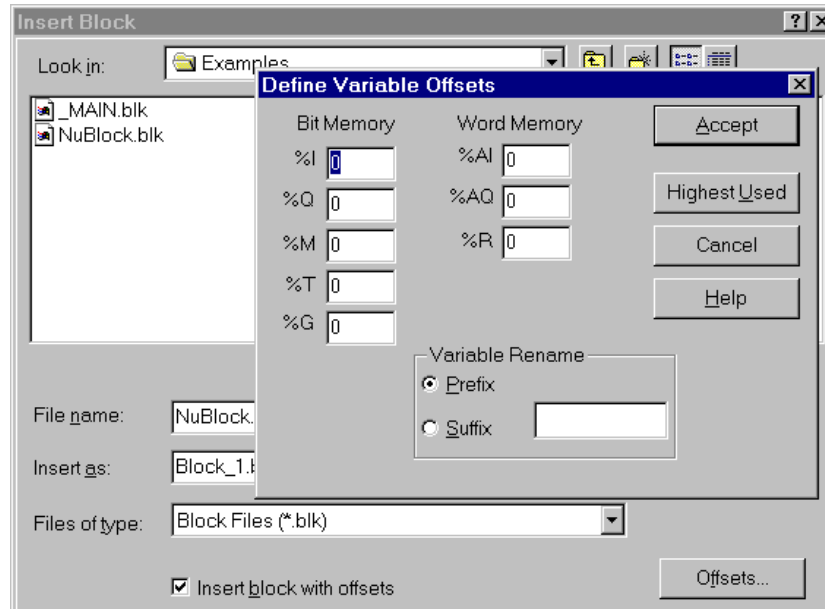

7. Make the needed changes in the Define Variable Offsets dialog box and click Accept.
 8. In the Insert Block dialog box, click Open.
- The block is copied to the current folder's directory.
- If the Folder itself, Hardware Configuration, or the Variable Declaration table are selected in the Folder Browser tree, the block is inserted at the bottom of the tree.
 - If a block or view table is selected, the block appears above the selected item.
 - If the inserted block has the same name as an existing block, an error message appears.
 - Adding a block includes adding the block's variables to the Variable Declaration Table. If the block being inserted contains variables that conflict with existing variables in the folder, the message, "Variable name/scope already exists in the variable declaration table" appears. Clicking OK, opens the Variable Resolution dialog box, which allows you to resolve variable conflicts. (See "Variable Resolution" in chapter 6.)
 - If you are inserting a "C" block, select the .exe file you created using the C Toolkit.

Opening a Block

Once a block is part of the Folder Browser, you can open and edit the block at any time. Multiple blocks may be open at the same time. To open a block in the Folder Browser, select the block you want to open and double-click the block name.

Note: "C" blocks cannot be opened in VersaPro.

Maximum Block Size

The following table lists maximum sizes for subroutine blocks.

VersaMax	16KB
VersaMax Nano/Micro	18KB
Series 90-30	16 KB for LD blocks 80 KB for C blocks
Series 90-70	32 KB for LD blocks 64 KB for C blocks

Inserting and Editing Objects

VersaPro allows you to associate objects with your folder. For example, you can insert an Excel spreadsheet, Word document or Access database file into your folder. Once the object is associated with your folder, you can edit the object by double-clicking in the Folder Browser.

To insert an object into a folder:

1. Open the folder into which you wish to insert an object. Go to the Folder Browser.
2. Select the item below which you want to insert an object.
3. Select the Insert menu and choose Object, or click the right mouse button and select Insert Object. The Insert Object dialog box will appear.
4. Select the name and the location of the file you want to insert. VersaPro component files (files with an extension of .blk, .fld, .hwc, .wvr, .wrt, or .vdt) may not be inserted.
5. Click Open. The object is inserted.

To launch an inserted object:

1. Open the folder containing the object that you want to launch. Go to the Folder Browser.
2. To open the object, double-click on the inserted object, or select the object using the up or down arrow keys and then press Enter, or select the object, click the right mouse button and choose Open.

If an application is associated with the folder type, the application will start up, opening the selected object. If no application is associated with the object, the standard “Open With” Windows prompt will appear.

Working with Blocks and Objects in the Folder Browser

VersaPro provides a flexible browser interface to manage the blocks, view tables, variable declaration tables and objects associated with the folder.

This section describes how to manage the files and information associated with the components in the Folder Browser.

Arranging Blocks

VersaPro allows you to change the order in which blocks are displayed and printed. (Blocks are printed in the order they appear in the Folder Browser). To rearrange the order, simply select the component you want to move and then drag and drop it to the new location. You can also move blocks using standard Windows cut, copy and paste commands.

Viewing and Modifying Block Properties

After a block is created, you can view and modify the block name, description and type.

Perform the following steps to edit the properties of a block.

1. From the Folder Browser, select the block whose properties you wish to view.
2. Select the Edit menu and choose Properties, Block, or click the right mouse button and choose Properties. The Properties dialog box will appear.

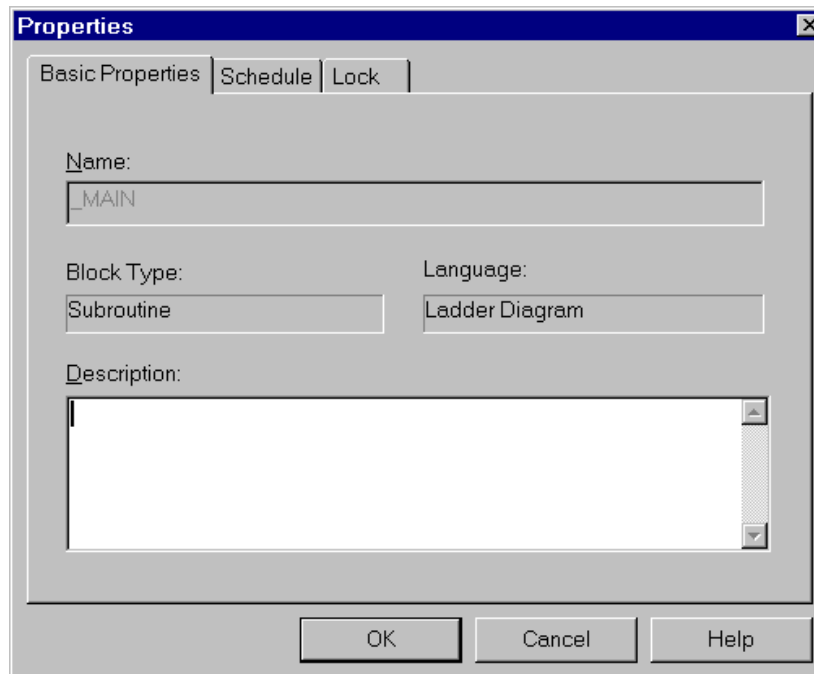

3. Select the General Properties tab, which displays the block's name, language, type, description, and description. You can edit the Name and Description.
4. To define Timed Interrupts or I/O Interrupts, select the Schedule tab.
5. To lock or unlock the block, select the Lock tab.

Moving Folder Components

VersaPro allows you to determine the order in which folder components, including logic blocks, are displayed and printed by dragging and dropping or cutting/copying and pasting.

You can cut or copy IL, LD, Motion, and Local Logic blocks, and view tables, and paste them in the same folder with a unique name or a repeated name with a suffix number. You can also drag and drop, and rename blocks and view tables. Block pasting and dropping works within and across folders. (_MAIN can be copied and pasted, but not cut.) When you copy or move a block, its properties will be included.

You can copy and paste (or drag and drop) Cam blocks within a folder, but not between folders.

You can copy and paste Hardware Configuration between folders, but not within the same folder.

Cutting Folder Components

Note: To cut a block, it must be closed.

1. Open the Folder Browser.
2. Select an item or number of items in the Folder Browser. The _MAIN block, VDT, Hardware Configuration, and Folder node cannot be cut.
3. Choose Cut from the Edit or Context-Sensitive menu, click the Cut button  or press Ctrl + X.

The selected item and its contents are moved to the clipboard. It may now be pasted within other VersaPro folders or to another application.

Copying Folder Components

Note: To copy a block, it must be closed.

1. Open the Folder Browser.
2. Select an item or number of items in the Folder Browser. The Folder node and the VDT cannot be copied.
3. Choose Copy from the Edit or Context-Sensitive menu, click the Copy button  or press Ctrl + C.

The selected item and its contents are copied to the clipboard. They may now be pasted within other VersaPro folders or to another application.

Pasting Folder Components

1. Cut or copy an item from the Folder Browser.
2. In the same or another folder, select an item above which you wish to paste the cut or copied item.
3. Select Paste from the Edit or Context-Sensitive menu, click the Paste button  or press Ctrl + V.
4. If the item you are pasting has been copied from the same folder, a dialog appears asking you to provide a new name for the item.
5. Type a new name for the item, then click OK.

The item is pasted above the selected item in the Folder Browser.

Dragging and Dropping in the Folder Browser

You can use drag and drop to move or copy a components within a folder or between VersaPro folders. The following drag and drop operations are allowed:

- Moving blocks, Reference View Tables and Variable View Tables within a folder browser (changing order)
- Copying the _MAIN block to a different folder (must rename the copy of _MAIN)
- Moving or copying blocks, Reference View Tables, and Variable View Tables between folders
- Copying Hardware Configuration between folders

Note: To drag and drop a block, it must be closed. Drag and Drop works only within VersaPro. Items are not placed on the clipboard and are not available to other Windows applications.

You cannot drag and drop the folder's root node.

Moving Folder Components

1. Select (highlight) an item in the Folder Browser.
2. Click and hold on the selected item. (The selected item is highlighted.)
3. Drag the image of the selected item to the desired location in the same or another folder.
4. Drop the image by releasing the mouse button.

The selected item and its contents are moved to the new location.

If you are dragging from one instance of VersaPro to another, and the drop action that you are attempting involves a conflict in variables (for instance, if you are copying a Reference View Table that contains a variable already defined in the target folder's VDT), the Variable Resolution dialog box appears so that you can change the conflicting variable to eliminate the conflict. You can change the variable name, type, length, or scope, then click OK. Or, click Cancel to cancel the drag and drop operation.

Copying Folder Components

1. Select (highlight) an item in the Folder Browser.
2. Press and hold the Ctrl key.
3. Click and hold on the selected item. (The selected item is highlighted.)

4. Drag the image of the selected item to the desired location in the same or another folder.
5. Drop the image by releasing the mouse button and the Ctrl key.

Variable conflicts are handled the same as for components being moved.

Deleting a Block

If you decide that a block is no longer desirable within a folder, you can delete it. If the block is `_MAIN`, it cannot be deleted, but the same procedure allows you to clear any contents from `_MAIN`. Deleting a block does not delete global variables from the Variable Declaration Table, but it does delete local variables.

To delete a block or View Table:

1. Open the folder from which you wish to delete a block. The folder must contain multiple blocks.
2. Make sure that the block to be deleted is closed.
3. Select any block except `_MAIN` in the Folder Browser tree.
4. Choose **Delete** from the Edit or the Context-Sensitive menu, click the Delete button , or press the Delete key.
5. A warning message appears asking if you are sure you want to perform this operation. If you click OK, the block is deleted from your folder and removed from the browser tree.

In the future, any reference to the deleted block will produce a warning at syntax check.

Global variables contained in a deleted block are not deleted from the Variable Declaration Table, but local variables are.

To delete the contents of the `_MAIN` block:

1. Open the folder from which you wish to delete the contents of `_MAIN`. Select `_MAIN` in the Folder Browser.
2. Press the Delete key, or click the delete toolbar button . You will be prompted that the contents of `_MAIN` will be cleared.
3. Click OK. `_MAIN` is cleared of all logic and the Block Description is cleared. Other blocks in the folder are kept intact and are unaffected by this operation. Variables local to `_MAIN` are deleted. Global variables are not deleted from the Variable Declaration Table.

Saving a Block

VersaPro allows you to save the selected block to its current location. If the VDT or the Folder Browser have changed, they are also saved.

To save a block

1. Select the block you wish to save.
2. From the File menu, choose Save. (This option is available only if the selected block has changed since the last save.) The active block and any changed items (VDT, folder) are saved.

Closing Blocks

You may wish to close a selected block, or close all open blocks, but leave other windows (for example, the VDT and Folder Browser) open.

- **To close a block:** Select the block you want to close. From the File Menu, choose Close. The selected block will close.
- **To close all blocks:** Select the Window menu and choose Close All. If a block contains unsaved changes, you will be prompted to save changes before closing the block.
 - Click Yes to save the changes and close the block.
 - Click No to close the block without saving.
 - Click Cancel to leave the block open.

Using Editing Operations on Folder Components

VersaPro allows you to use any of the standard editing commands to cut, copy and paste information. VersaPro also supports undo and redo to manage changes made to folder components.



This section describes how to use windows-standard commands to manage data and changes in the VersaPro Folder Browser.

Using Undo and Redo

VersaPro allows you to undo or redo certain actions (like placing an element or deleting a row) in Hardware Configuration, in the Variable Declaration Table, in the Variable View Table, and in the IL Editor or LD Editor.

You can undo or redo actions using the standard menu commands, keyboard shortcut keys, or toolbar buttons.

The number of undo/redo operations supported can be set to a value between 1 and 100 (the default is 10). To adjust the number of undo/redos supported by VersaPro, select the Tools menu and choose Options. If you are about to perform an action which, due to its complexity or the amount of data involved, cannot be undone, a message box will appear, warning you of this fact.

- **To undo an action:** Click the Undo toolbar button. , select the Edit menu and choose Undo, or press Ctrl+Z. The Undo menu option will be grayed out if there is no previous undo operation to perform.
- **To redo an action:** click the Redo button , select the Edit menu and choose Redo, or press Ctrl+Y. The Redo menu option will be grayed out if there is no previous operation to redo.

Working with Variables while Editing Blocks

VersaPro allows you to create variables while you are working with logic. One way to do this is to add a block with new variables to your logic. New variables included in an added block are checked for validity. If they are valid, they are added to the Variable Declaration Table and are available for use.

Temporary variables must be declared if you are using Instruction List for blocks.

To create a variable when adding a block:

1. Open a folder.
2. Add a block with defined variables to the folder.
3. Row validation is performed on each variable to check for global scope conflicts with existing variables.
4. If a variable fails row validation, an error message appears describing the problem.
5. Click OK A dialog box appears allowing you to correct the problem. If the problem is corrected, row validation continues for other variables. If you click Cancel, the variable is not added to the VDT, and the entire process is cancelled. When row validation is completed and no conflicts exist, the Variable Declaration Table is populated with original data and with data from the added block.

To assign temporary variables:

1. Open a folder. Choose Properties from the Edit menu or from the Context-Sensitive menu in the Folder Browser.
2. The Properties dialog box appears.
3. Select the Temporary Variables tab.
4. Select the Temporary Variables (IL) radio button.
5. The starting address fields for Boolean and Integer variables become enabled.

Note: If at any point you wish to delete the current temporary variables, you can do so by selecting the No Variables (IL) radio button. The memory areas used for Temporary variables may not overlap with those used for Conversion variables.

-
6. To assign temporary Boolean variables, enter a valid starting bit address.
 - Boolean Temporary variables can only be assigned in the %M, %Q and %T Memory areas.
 - Boolean Temporary variables must start on a byte-aligned address (for example: 1, 9, 17, etc.) and use 8 bits of memory.
 7. To assign integer temporary variables, enter a valid starting word address.
 - Integer Temporary variables can only be assigned in the %R, %AI and %AQ Memory areas and use 2 words of memory.
 - Starting and ending address values must be in the range 1 - 99,999
 - Neither starting address field may be left empty. As you type each starting address, its ending address is dynamically calculated and displayed in the read-only field beneath it.
 8. Click OK. If all starting and ending values are valid, the dialog box is closed and the temporary variables are added to the VDT's Temporary tab. Syntax Check checks for the appropriate creation and correct number of temporary variables.

Searching and Replacing in VersaPro

VersaPro provides a number of tools to navigate, locate, and search for and replace data in folder components. This section describes the methods of locating information and using search and replace in the Folder Browser.

Navigating in VersaPro

There are several methods of finding and going to certain points in folder components:

Go To: This action allows you to go to a specific row or rung in language editors (IL or LD), or to locate and go to the location of a specific variable.

Find: This action allows you to locate variables, reference address or call references in block logic.

Edit Variable: Selecting this command from the IL or LD editor will take you to the variable definition in the Variable Declaration Table.

Locating and going to a Rung, Row or Variable

You can use the Go To feature to change focus to a specific Rung (LD Editor), Row (IL Editor) or Variable (Variable Declaration Table).

Follow the steps below to use the Go To feature:

1. Place the cursor in the LD Editor, IL Editor, or Variable Declaration Table.
2. Select the Edit menu and choose Go To (LD or IL Editor) or choose Go To Variable (Variable Declaration Table). The Go To dialog box will appear.

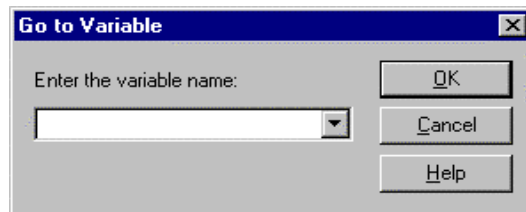
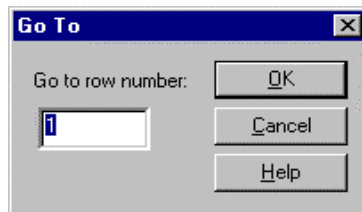

3. Complete the dialog box as described for the LD Editor, IL Editor or Variable Declaration Table. After entering the rung, row or name, click OK.

LD Editor: Type the number of the rung you want to go to.

IL Editor: Type the number of the row you want to go to.

Variable Declaration Table: Type the name of the variable you want to go to.

Locating Names, Instructions, Addresses or Call Statements in Blocks

You can use the Find In Blocks feature to find all occurrences of variable names, reference addresses, instructions, or call subroutines in IL and LD blocks.

Follow the steps below to use the Find In Blocks:

1. From the Folder Browser or folder components, select the Edit menu and choose Find In Blocks. The Find In Blocks dialog box will appear.

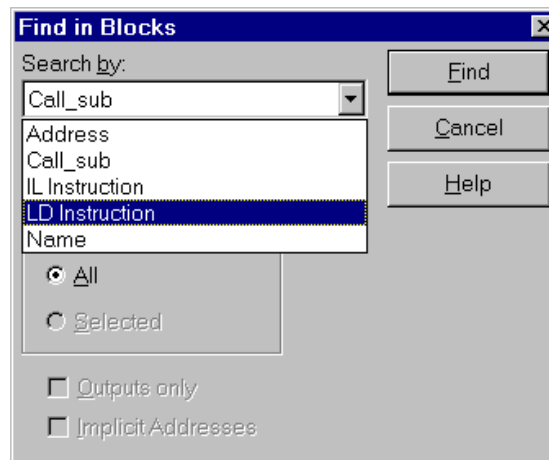

2. Complete the dialog box as follows: Click the Find button to start the search.

- **Search By:** Specifies what you are searching for
 - Address:** Select address to search for a reference address.
 - Call Sub:** Select Call Sub to search for a call to a subroutine block.
 - IL Instruction:** Searches for an Instruction List instruction.
 - LD Instruction:** Searches for a Ladder Diagram instruction.
 - Name:** Select Name to search for a variable name
- **Search For** Sets the address, block name, instruction, or variable name to be used in the search.
- **Blocks:** Establishes the scope of the search. Choose All blocks or Selected blocks (searches all blocks currently selected in the Folder Browser)
- **Outputs Only:** Limits the scope of the search to references used as outputs only (coils). To limit the search to outputs only, check this box.
- **Implicit Addresses:** Allows you to locate logic where an address is used, but is not referenced explicitly in the function block. To search for implicit addresses, check this box.

The search is performed, and the results of the search appear in the Information Window. Found items are listed by block, rung or row, and instruction. Double-clicking an item in the Information window opens the appropriate block and selects the matching element.

Using Search and Replace

VersaPro allows you to search for and replace elements in block logic. You can search for variable names, reference addresses and other elements in block logic and replace the search item with a new name or address.

Follow the steps below to use the Find/Replace feature.

1. Open the block you want to modify using search and replace. Select the Edit menu and choose Find/Replace. The Find/Replace dialog box will appear

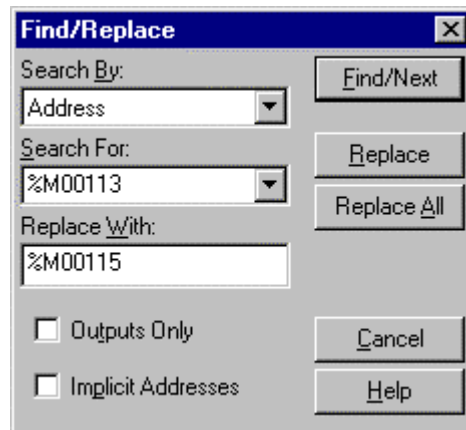

2. Complete the dialog box as follows
 - **Search By:** Use this field to define what you are searching for.
 - Address:** Select address to search for a reference address.
 - Call Sub:** Select Call Sub to search for a call to a subroutine block.
 - Name:** Select Name to search for a variable name.
 - Jump(n)/Label(n):** Select this choice to search for a Jump or Label in your program.
 - MCR(N)/END_MCR(N):** Select this choice to search for MCR/ENDMCR functions in your program.
 - **Search For:** Use this field to set the address, block name, variable name or label to be used in the search/replace

-
- **Replace With:** Enter the string, address, label or variable name which will be used in the replace operation.
 - **Outputs Only:** To limit the scope of the search to references used as outputs only (coils), check this box.
 - **Implicit Addresses:** To locate addresses which are included, but not named in a function block (for example, in an array), check this box.
3. Select the action you want to perform:
 - **Find Next:** Click this button to find the (next) instance of the search string in your program.
 - **Replace:** Click this button to replace the highlighted instance of the search string in your program.
 - **Replace All Button:** Click this button to replace all occurrences of the search string in your program.
 4. To close the Find/Replace dialog box, click the Cancel button.

Note: If a Find and Replace action has been specified during the current edit session, you can use the Find Next to locate additional occurrences of the search string using the Find Next command. To find the next instance, select the Edit menu and choose Find Next, or press F3.



Performing Syntax Checks

VersaPro provides syntax checking for logic blocks. Once you've created block logic, you can check either portions of the folder or the entire folder (all blocks) for syntax errors.

In a syntax check, instructions within your logic are compared against information about the configured PLC. Any unsupported instructions are flagged.

Syntax checking is automatically performed when you store or verify logic to the PLC.

To manually initiate a syntax check perform the following steps:

- To **Check All Blocks**, go to the Folder Browser, click the right mouse button and select Check All  or select the Check All Blocks toolbar button.
- To **Check Selected Blocks**, highlight the blocks you want to check in the Folder Browser, click the right mouse button and select Check Selected Blocks  or select the Check Selected Blocks toolbar button.

The block(s) are checked. All warnings and errors are written to the Information Window.

Note: You can navigate to the location of the syntax error by double-clicking on the error in the Information Window.

Converting Block Logic

VersaPro allows you to convert IL logic to LD logic (and from one editor) to another. Most, but not every, formation in one language can be translated to the other. Certain exceptional instructions may lead to errors upon attempted conversion. Therefore, if you intend your logic to be translatable, avoiding a particular set of instructions will minimize the errors you encounter. (See "Rules for Successful Conversion" on page 3-25.)

Note: Blocks are converted on an instruction by instruction basis, so logic is not optimized for the LD language.

Note: Series 90-70 and Series 90 Micro PLCs do not support IL programming.

Assigning Conversion Variables

1. Open a folder.
2. From the Edit menu, choose Properties, Variable Table, or select the Variable Declarations node and choose Properties from the CSM.
3. The Properties dialog box appears.
4. Select the Conversion Variables (LD) tab.
5. Select the Conversion Variables (LD) radio button.
6. The starting address fields for Boolean and Integer variables become enabled.

Note: If at any point you wish to delete the current temporary variables, you can do so by selecting the No Variables (IL) radio button.

7. To assign Boolean variables, enter a valid starting bit address.
 - Boolean conversion variables can only be assigned in the %M, %Q and %T Memory areas and must start on a byte-aligned address (for example: 1, 9, 17, etc.).
8. To assign integer variables, enter a valid starting word address.
 - Integer conversion variables can only be assigned in the %R, %AI and %AQ Memory areas.
 - Starting and ending address values must be in the range 1 - 99,999
 - Neither starting address field may be left empty.

As you type each starting address, its ending address is dynamically calculated and displayed in the read-only field beneath it.

9. Click OK.

If all starting and ending values are valid, the dialog box is closed and the temporary variables are added to the VDT's Temporary tab.

Converting Block Logic

Once conversion variables have been configured, you can select a block for conversion. Be sure to check the block's syntax before converting the block. (Select Check Block or Check All from the Folder menu.)

1. Select a block in the Folder Browser, or make the block you want to convert the active block.
2. Select the Tools menu and choose Convert Block.

The logic in the block you are attempting to convert is checked for syntactical validity. If the logic is found to be syntactically valid, the logic is converted from one language to the other, and the details of the conversion appear in the Information Window.

If any syntax errors are found, they are logged in the Information Window and the conversion is aborted.

Rules for Successful Conversion

The following guidelines are suggested for successful block conversion:

- IL logic containing the following instructions cannot be converted to LD
 - XOR, XORN, XOR(
 - ANDN(, ORN(, XORN(
 - NOT
- Use the Properties dialog box to define the use of temporary variables, which are necessary for IL logic, and conversion variables, which are necessary whenever you convert IL logic to the LD language.

Converting Non-Nested Instructions

Series 90 Micro and low-end 90-30 PLCs support non-nested forms of the MCR, ENDMCR, JUMP, and LABEL instructions. When you import a Logicmaster folder containing non-nested instructions or convert a Series 90 Micro folder to a VersaMax Nano/Micro folder, these instructions will not be automatically converted to nested forms. To be able to compile your programs after conversion, you will need to change these instructions to their nested forms (MCRN, ENDMCRN, JUMPN, and LABELN).

To convert non-nested instructions, go to the Tools menu and select Non-Nested to Nested Conversion. You will be prompted to indicate whether you wish to proceed with the conversion. To proceed, click OK.

Note: All non-nested instructions will be converted to their nested forms. This conversion may increase the size of the compiled logic. Also this conversion cannot be undone.

Chapter

4

Working in the LD Editor

The LD Editor window allows you to create, edit, display and monitor programs and blocks created in ladder logic. This chapter introduces you to the LD Editor window and how you can customize its look as well as how to create and edit logic.

Chapter Contents

- How to access the LD Editor
- An overview of the LD Editor Window
- How to customize the LD Editor Window display and set rung editing and coil checking options
- How to enter and edit logic

Overview of the LD Editor

The Ladder Diagram Editor is used to create programs using the Ladder Diagram programming language. Ladder Diagram is used to graphically represent the actions to be performed by a PLC.

The editor window is divided into rows (rungs). Each rung is divided into cells. Each cell can accept a logic element (function block or relay function.). The LD Editor allows you to enter ladder logic elements via keyboard, mouse, or toolbar. All elements are inserted by overwriting the contents of the selected cell.

The figure below shows some of the commonly-referenced components of the LD Editor window and browser view.

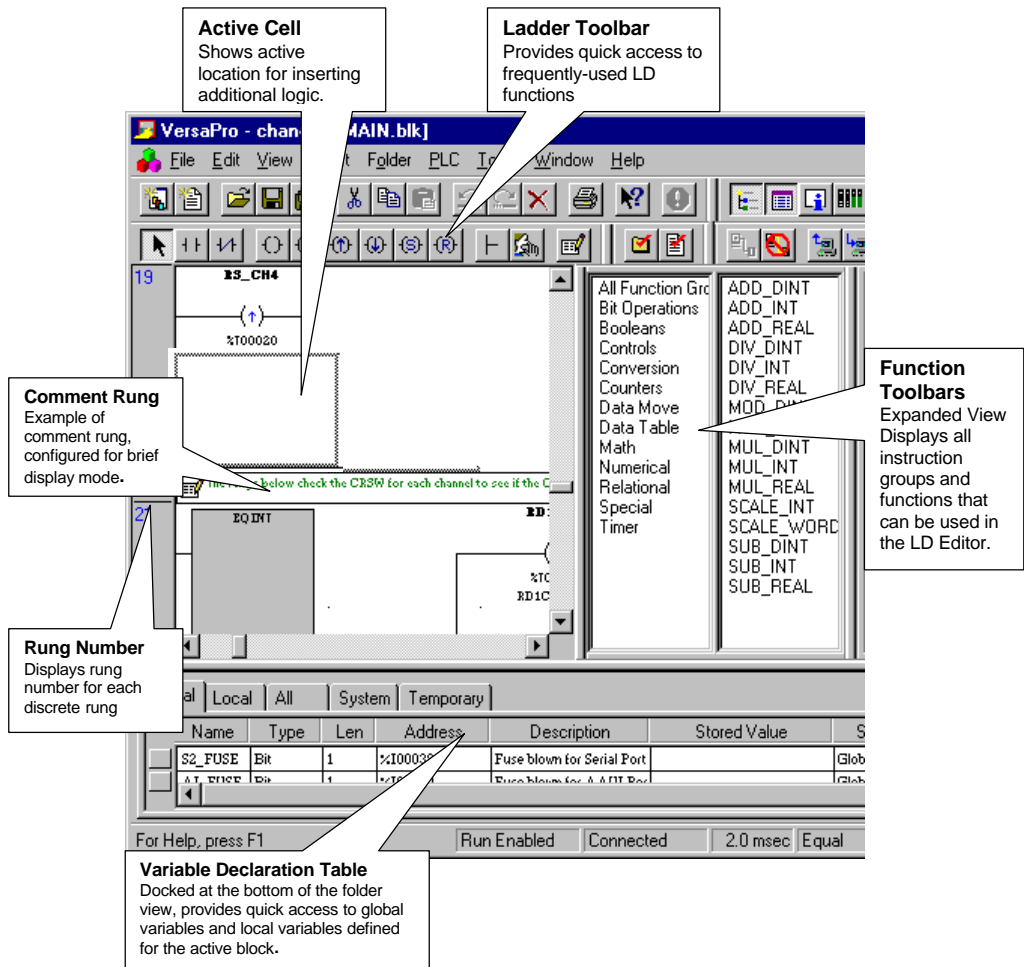

Customizing the LD Editor Window

VersaPro allows you to select the format of information displayed in the LD Editor window and control the grid and display size.

This section describes the elements of the LD Editor window which can be customized.

Customizing Ladder display options

When working in the LD Editor, you may want to customize the fields which display online. Perform the following steps to customize Ladder display options:

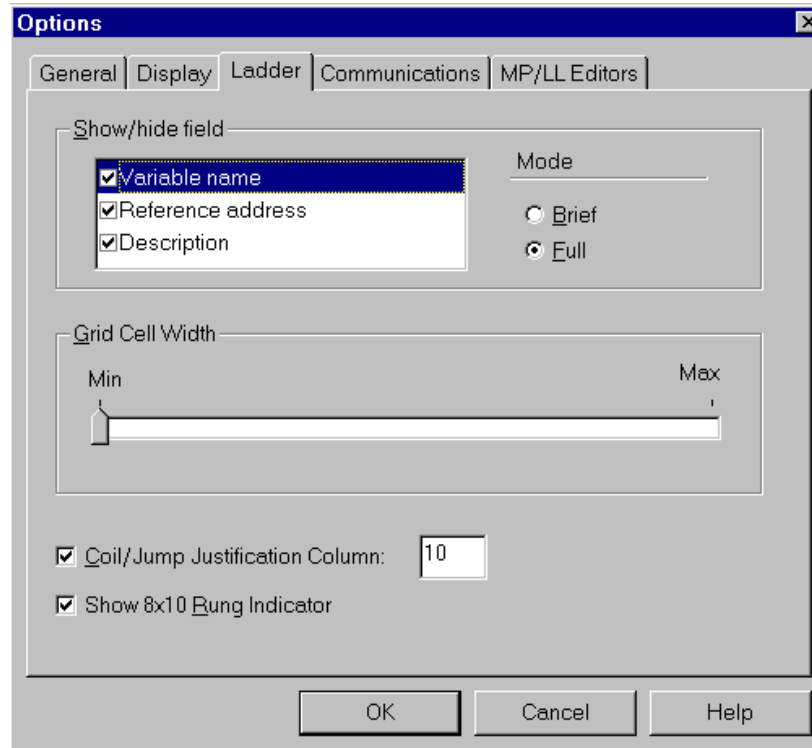

1. Select the Tools menu and choose Options, or click the right mouse button from the LD Editor and choose Options. The Options dialog box will appear. Select the Ladder tab.



2. Customize the display options to suit your needs: Click the OK button to accept changes.
 - **Show/Hide Field:** Allows you to set the fields which will display in the LD Editor window:
 - **Variable Name:** You can set the display mode to brief or full by selecting Variable Name and clicking the appropriate button in mode. checking the appropriate button. Brief mode displays one line, and full mode displays up to two lines.
 - **Reference Address:** To view the reference address associated with variables, check this box.
 - **Description:** To view the variable description, check this box. If you want to see the entire description, you may also need to increase the Grid Cell Width. You can also set the display mode to brief or full by checking the appropriate button. Brief mode displays one line, and full mode displays up to four lines.
 - **Grid Cell Width:** Allows you to make the grid for cells wider or narrower. To increase or decrease the width, slide the control between Min and Max.
 - **Coil Justification Column:** If this box is checked, when you insert a coil, it is placed in the column specified (right justified). Valid values are integers 10 to 20. If this box is not checked, coils are inserted in the next empty column.

Adjusting the Zoom Ratio

You can increase or decrease the zoom ratio for the LD Editor by click the zoom in/zoom out buttons. To adjust the zoom ratio perform the following steps:

1. Make an LD block active
2. Select the View menu and choose Zoom In  or Zoom Out . You can also click the toolbar buttons.

Entering Instructions and Instruction Parameters

This section describes how to enter and modify instructions and rungs in your ladder program. Program logic consists of elements such as relays, timers, math functions and other functions placed together to form rungs of logic. Variables and constants are assigned to function parameters as inputs and outputs to the function.

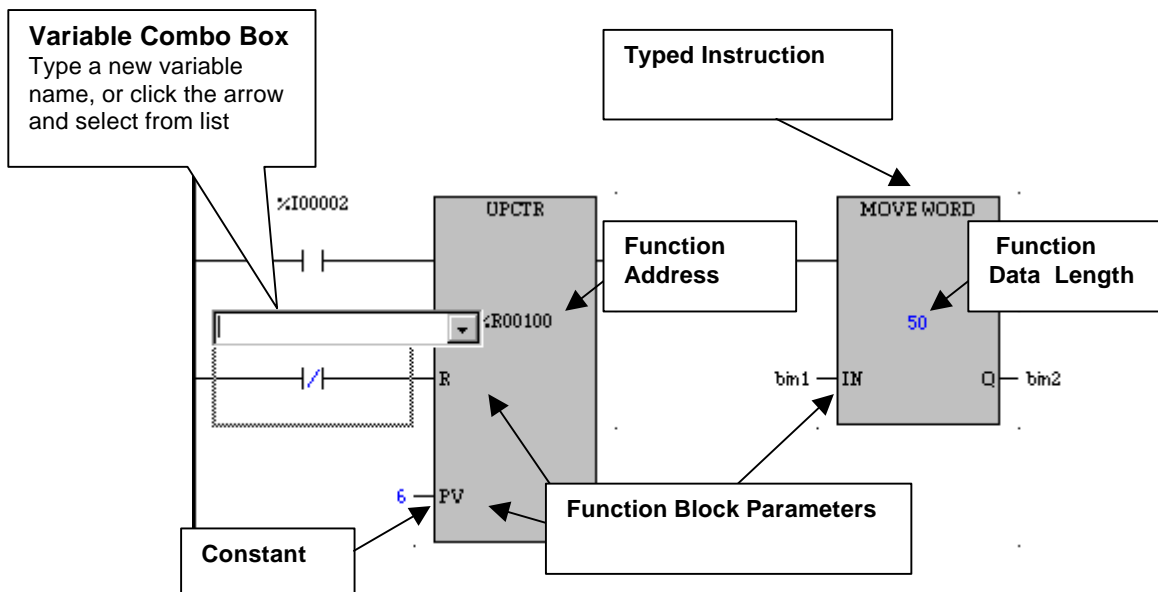

The example above highlights some of the concepts and details you will encounter entering logic in the LD Editor.

- **Typed Instructions (Functions):** In VersaPro, many function blocks are "typed". This means that the type (INT, DINT, REAL) is associated with the function, not the variable.
- **Function Data Length:** Many functions require a data length. The length is associated with the function, not the variable.
- **Function Address:** Displays the reference address if required by the function block.
- **Function Block Parameters:** Input and Output parameters to function blocks must be completed. Many function block parameters require variables or constant values, like the Add function. Other function blocks require Boolean parameters (like contacts) to enable or control how the function executes.

- **Variable Combo Box:** When assigning variables to function block parameters, the variable combo box allows you to quickly select existing variables or create new variables.

Entering Instructions

There are several methods of entering instructions into the LD Editor to suit personal preferences and editing styles. With VersaPro, you can enter instructions using the Function Toolbar, Ladder Toolbar or through direct keyboard entry (where no mouse interaction is required). This section describes the various ways you can enter instructions into your program.

Entering Instructions using the Function Toolbar

The Function toolbar is used to select and add function blocks to your LD program. The Function Toolbar can be displayed in either of two forms. The compact form, which requires less room on the screen and the expanded form, which displays all the groups and their functions.

Selecting Functions Using the Function Toolbar – Compact

The Function Toolbar, displayed in compact form, consists of a Group combo box, an Instruction combo box, and a Function Drop button. To select Compact form, select the View Menu, choose Function Toolbars -> Compact. The function toolbar will appear above the LD Editor window.

The screenshot shows the LD Editor interface. On the left is a 'Function Groups' list with a dropdown arrow. The 'Data Move' group is selected. On the right is a 'Functions' list with a dropdown arrow. 'BLK_CLR_WORD' is selected. A 'Function Drop Button' is located to the right of the 'Functions' list. Three callout boxes provide instructions: 'Function Drop Button' (click to select function and drop into LD program), 'Functions' (shows instructions for the active group), and 'Function Groups' (click arrow to select group or view all).

Function Group	Function
All Function Groups	BLK_CLR_WORD
Bit Operations	BLKMOV_INT
Booleans	BLKMOV_REAL
Controls	BLKMOV_WORD
Conversion	COMM_REQ
Counters	MOVE_BOOL
Data Move	MOVE_INT
Data Table	MOVE_REAL
Math	MOVE_WORD
Numerical	SHFR_BIT
Relational	SHFR_WORD
Special	
Timer	

Function Drop Button
Click button to select function, then click in the editor window to drop the function into your LD program.

Functions
Shows instructions available for the active Function Group.

Function Groups
Click the arrow to select a specific function group, or to view all function groups.

- To select a function group, click the arrow on the Function Groups box and choose a function group. To view all instructions, select All Function Groups.
- To select an instruction, click the arrow on the Functions box – use the mouse to scan through the list or type the first few characters of the function name to locate in the list.
- To drop the function in the LD Editor window, click the Function Drop Button, position the cursor at the insert location in the LD Editor window, and click to drop the function into your program.

Selecting Functions Using the Function Toolbar – Expanded

The Function Toolbar, displayed in expanded form, consists of a Group window and Instruction window. To select Expanded form, select the View Menu, choose Function Toolbars -> Expanded. The Group and Instruction windows will appear to the right of the LD Editor window.

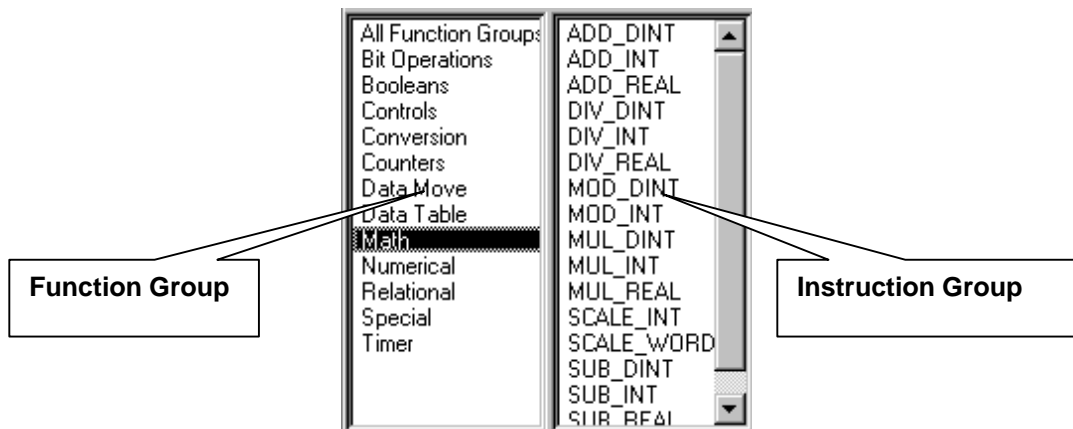

- To select a function group, highlight the Function Group name in the Group window. To view all instructions, select All Function Groups.
- To select an instruction, use the slide control to scan the list of instructions, locating the instruction you want to add to your program.
- To drop the function in the LD Editor window, double click the instruction name (notice that the cursor changes to a function block icon), position the cursor at the insert location in the LD Editor window, and click to drop the function into your program.

Entering Instructions using the Ladder Toolbar

You can use the Ladder Toolbar to select commonly-used Boolean functions, comments and call instructions to your LD program.

To select one of the toolbar instructions, simply click the toolbar button, move the cursor to the insertion point, and click to place the instruction.

The comment toolbar button places a comment at the current cursor location.

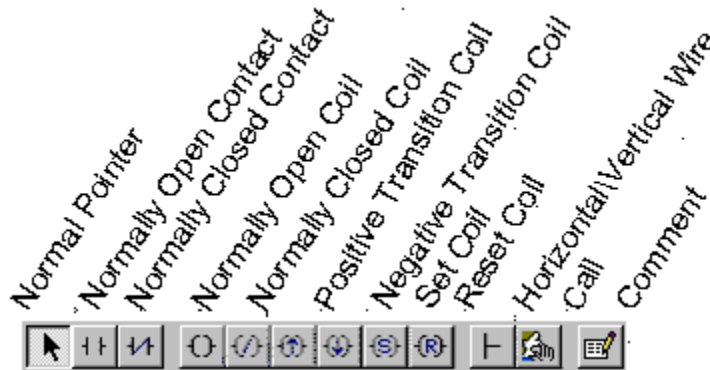

Note: When a function or instruction is selected, an instance of the function will be inserted into your LD Program each time you click the mouse button. To de-select the active function, click the Normal Pointer toolbar button.

Entering Instructions using Keyboard Entry

It is possible to enter logic directly with the keyboard, rather than using the mouse. Perform these steps to enter an instruction using keyboard entry:

1. Navigate to the cell where you want to insert an instruction.
2. Press Shift + Enter. A combo box containing the list of all instructions will appear. (If the cell is empty, simply press Enter.)

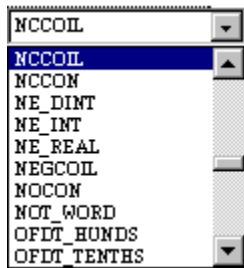

3. To locate the function, type the first few characters of the instruction name, or use the arrow keys to scroll through the list.
4. Press Enter to select the name and insert the instruction into your program.

Completing Address and Length Information

Certain function blocks require you to supply a length (for example, a Move Instruction) or an address (for example, a Timer Instruction) for the function to operate correctly. Functions which require this information will display ?? inside the function block. Perform the following steps to complete address or length information:

1. Enter a function which requires address or length information. Notice the ?? fields on the function block.
2. Double-click the ?? area or select the function and press Enter. The Function Properties dialog box will appear so that you can enter a length and/or address, as appropriate.

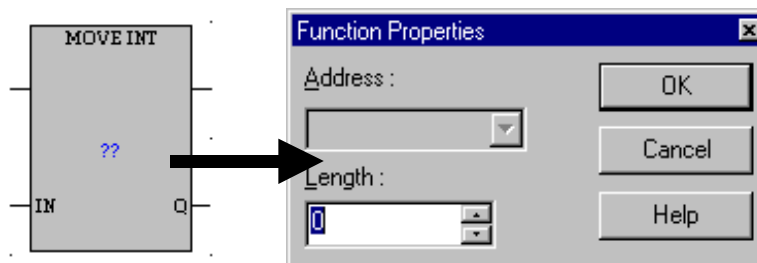

3. Type a length or address, depending on the active parameter in the Function Properties dialog box. Click OK when the information is complete.
4. The function will display the length and/or address supplied in the Function Properties dialog box.

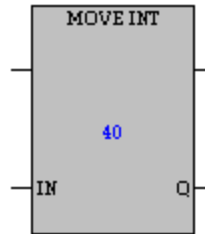

Completing Function Block Parameters

After a function block, coil or contact is added to the program, you need to assign a variable or constant to each parameter. This section describes how to complete function block parameters in one of the following ways:

- Assign an existing variable to a parameter
- Creating a new variable for a parameter
- Assigning a constant value to a parameter

Assigning Variables to Function Block Parameters

Variables can be assigned to elements and parameters in ladder logic. Variables may be Local Scope (local to the block) or Global Scope (Global to all blocks in the folder). The default scope for variables is Global Scope.

You may assign an existing variable or create a new variable for the function block parameter. This section describes how to assign variables to parameters using the mouse and the keyboard.

Note: You can also drag and drop selected variables from the Variable Declaration Table to the function block parameter.

Note: Declaration of variables with overlaps will result in conflicts when you attempt to Store the stored values to the PLC. In order to resolve these conflicts, you must use the VDT to relocate variables so that they do not overlap. (For example a variable at %R8 with length 3 and a variable at %R10 of length 2 have an overlap at %R10.)

To assign an existing variable using keyboard entry:

1. Use the arrow keys to position the cursor on the parameter where you want to assign a variable.
2. Type or select the variable as follows:
 - To select a variable from the list of defined variables, press Enter. The variable combo-box will appear. Use the up and down arrow keys to display the variables. When you find the variable you want to use, press Enter to accept.
 - To enter a variable by name, simply type the variable name. Press Enter to accept.

To assign an existing variable using the mouse:

1. Double-click on the parameter cell where you want to assign a variable. The variable combo-box will appear.
2. To expand the variable list, click the arrow on the combo-box. Use the slide control to scroll up and down through the list.
3. Select the variable from the list. Press Enter, or click outside the parameter cell area to accept.

To create a new variable for a function block parameter

1. Select the parameter cell using the keyboard or mouse
 - **Keyboard Select:** Use the arrow keys to position the cursor on the parameter where you want to assign a variable. Press Enter. The variable combo-box will appear.
 - **Mouse Select:** Double-click the parameter cell. The variable combo-box will appear.
2. Type a variable name, reference address and scope (optional) into the edit box using the following guidelines. (Fields must be separated by commas.)

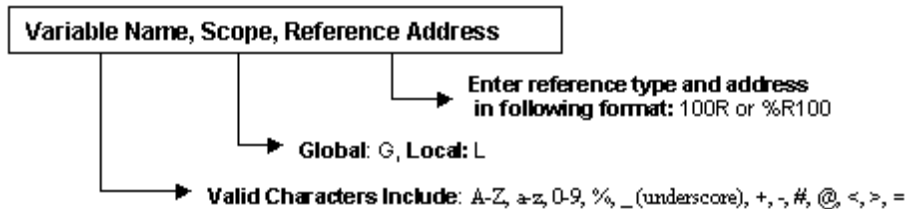

- The following example shows creating a variable "LINE2_COUNT" for parameter IN2 of the ADDINT Function.

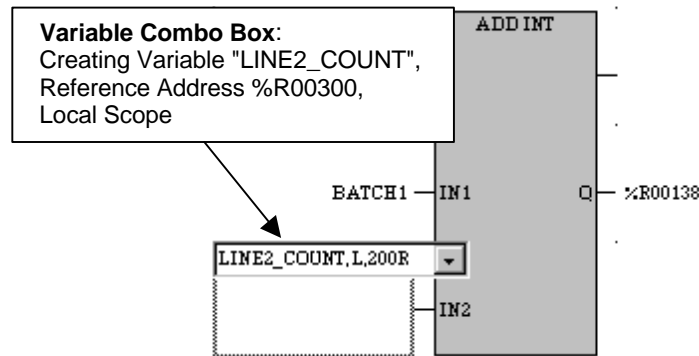

- To accept the variable, press the Enter key – or use the mouse to click off the active cell.

Note: To edit information for an existing variable, select the variable in the LD Editor, click the right mouse button and choose Edit Variable. The variable will be highlighted in the Variable Declaration Table, allowing you to edit information about the variable.

The exceptions in changing LD logic involve replacing existing variables. When a variable is replaced, information about that variable is still retained in the Variable Declaration Table. If you replace the existing variable with a new variable, the new variable information is added to the Variable Declaration Table. In some cases, a constant can be replaced by a variable.

You can replace a variable (or constant) either with an existing variable, or with a new variable.

To replace a variable with an existing variable in LD:

- Select the parameter cell using the keyboard or mouse
 - Keyboard Select:** Use the arrow keys to position the cursor on the parameter where you want to assign a variable. Press Enter. The variable combo-box will appear. The current variable or constant will display in the edit field.
 - Mouse Select:** Double-click the parameter cell. The variable combo-box will appear. The current variable or constant will display in the edit field.
- Type the name of the replacement variable, or enter a constant. Press Enter to accept.

Assigning Constants to Function Block Parameters

Constants can be assigned to functions and parameters in ladder logic. Constant values are displayed during monitoring, in the default type format of the element in which each is used.

To assign a constant using keyboard entry:

1. Use the arrow keys to position the cursor on the parameter where you want to assign a constant.
2. Type the constant value. Press the Enter key. If the constant is not valid for the function block an error message will appear.

To assign a constant using the mouse:

1. Click the arrow button  to de-select any active functions. Double-click on the parameter cell where you want to assign a variable. The variable combo-box will appear.
2. Type the constant value. Press the Enter key. If the constant is not valid for the function block an error message will appear.

Rules on constants

A constant's value may not exceed the capacity of the operand's type and must be entered in a format consistent with the Function Block type:

Format	Prefix	Example
Decimal (default)	None	43
Real	None	43.72
Scientific	None	6.93e4
Binary	2#	2#11110000
Octal	8#	8#730
Hexadecimal	16#	16#dc4b

Editing Ladder Logic

Once logic is in your LD program, you may need to edit, copy, or delete sections of logic. This section describes how to select logic in the LD editor, and how to delete, copy and paste selected logic.

Selecting Logic

Before you can perform editing operations on LD logic, you need to select the logic you plan to work with. This section describes how to select logic using the mouse and keyboard.

To set a selection in the Ladder Editor using the mouse:

1. Make sure placement mode is off by clicking on the arrow button (normal pointer) on the Ladder toolbar. 
2. Place the mouse pointer over a cell or over the power rail next to a rung.
3. Press and hold the primary mouse button.
4. Drag the mouse to move the selection over the desired cells, or along the power rail over the desired rungs.
5. To select non-contiguous rungs, hold down the Ctrl key while selecting rungs. The desired rungs are selected.

To set a selection in the Ladder Editor using the keyboard:

1. Make sure placement mode is off by pressing Esc.
2. Select cells:
 - To select a single cell, navigate to the desired cell and press the spacebar.
 - To select a group of cells, navigate to a cell, then hold down the Shift key while using navigation keys to move the selection over the desired area.
 - To select a single rung, navigate to the power rail and press Ctrl + the spacebar.
 - To select a contiguous group of rungs, navigate to the power rail. The entire rung is implicitly selected. To select more rungs, hold down the Shift key and use the up or down arrow keys to move the selection over contiguous rungs.
 - To select non-contiguous rungs, select a single rung, hold down the Ctrl key, navigate to another rung, and press the spacebar. The rungs are selected.

Using Cut, Copy, Paste and Delete in the LD Editor

In the LD Editor, you can cut or copy rung(s) or cell(s) from one portion of a ladder to another portion, or from one block to another, without removing the variables included in those rungs or cells from the Variable Declaration Table.



You can also delete selected rungs or cells.

Logic cannot be pasted from LD blocks to IL blocks, nor can you paste LD logic to applications other than VersaPro. You can, however, copy ladder logic as a bitmap image.

You can paste a variable from the VDT to the LD Editor.

This section describes the different ways you can perform cut, copy, paste, and drag-and-drop in the LD Editor window.

To cut or copy in the LD Editor:

1. Open the LD block you want to edit. Select rung(s) or cell(s) you want to copy or cut.
2. Choose **Cut** or **Copy** from the Edit or right mouse menu, click the Cut  or the Copy  button on the Standard toolbar, or press Ctrl+C to Copy or Ctrl+X to Cut. The selected information is cut or copied to the Clipboard.

To cut or copy in the LD Editor using Drag and Drop:

1. Open the LD block you want to edit. Select rung(s) or cell(s) you want to copy or cut.
2. **To Cut** (using drag and drop), position the mouse arrow over the selected logic, press down and hold down the primary mouse button.

To Copy (using drag and drop), position the mouse arrow over the selected logic, press and hold the CTRL key, then press and hold the primary mouse button.

3. Move the logic to the appropriate area. To drop the selection, release the mouse button and/or the Ctrl key.

To copy as a bitmap in the LD Editor:

1. Open the LD block you want to edit. Select rung(s) or cell(s) you want to copy.
2. Select the Edit menu and choose Copy As -> Bitmap.
3. The selected information is copied to the Clipboard as a bitmap image. This image may be pasted into any application which recognizes the bitmap image.

To paste in the LD Editor:

1. Open the LD block you want to edit. Select rung(s) or cell(s) you want to copy.
2. Select the Edit menu and choose Paste , click the Paste toolbar button or press Ctrl+V.
3. The elements are pasted into the ladder. The paste operation overwrites any elements previously existing in the destination cells. Existing comments, Labels, or MCRs are shifted down in order to accommodate a pasted element(s).

To delete one or more elements:

1. In the LD Editor, select a row or a group of rows, a cell or rectangular group of cells, or one or more rungs.
2. Select the Edit menu and choose Delete, click the Delete button  on the toolbar, or press the Delete key. The selection is deleted. Variables defined in the deleted logic remain in the VDT.

Note: Cut/Copy/Paste/Delete actions may be undone by selecting the Edit menu and choosing Undo, or by clicking the Undo toolbar button..

Inserting an empty row in the LD Editor

Perform these steps to insert an empty row into the LD Editor.

1. Open the block you want to edit.
2. Select any instruction in the row above which you wish to insert an empty row.
3. Select the Insert menu and choose Row, press the Insert key, or click the right mouse button and select Insert Row. An empty row is inserted above the selected row. All subsequent rows move down one row. The cell in the new row immediately above the insertion point is selected. If a cell in the first row of the rung is selected, the new row is appended to the previous rung. If a cell in the first row of the first rung is selected, a new rung is created above the first rung.

To go to the next coil:

In the LD Editor, select a contact or coil.

Choose Go to the Next Coil from the Edit menu or the CSM (or press Alt + F3.)

The cursor will go to the next coil that has the same name as the contact or coil you started from.

Chapter 5

Working in the Instruction List Editor

The Instruction List Editor window allows you to create, edit, display and monitor programs and blocks created in Instruction List. This chapter introduces you to the IL Editor window and how you can customize its look as well as how to create and edit logic.

Chapter Contents

- How to access the IL Editor
- An overview of the IL Editor Window
- How to customize the IL Editor Window display
- How to enter and edit logic
- Details about Instruction List Operation

Overview of the Instruction List Editor

The Instruction List Editor is used to create programs using the Instruction List programming language. Instruction List is a text-based language which consists of a series of instructions, which combined, represent actions to be performed on a PLC.

Row Numbers:
Lists the number for each row in the IL Editor

Instruction List Editor Window:
Displays IL Logic. Columns include Label, Instruction, Operand, Reference Address, Value and Comment.

Active Cell:
To change the contents of the active cell, double click the cell. A combo-box will appear, displaying valid choices based on the insertion point.

Variable Declaration Table
Lists all variables which can be used in your IL logic.

Label	Instruction	Operand	Ref. Address	Value	Comment
1	LD_BOOL	%I00001	%I00001		
2	AND	%I00005	%I00005		
3	ST_BOOL	%Q00001	%Q00001		
4	LD_BOOL	%I00001	%I00001		
5	AND	%I00002	%I00002		
6	ANDN	%I00005	%I00005		
7	ST_BOOL	%M00115	%M00115		
8	LDN_BOOL	%M00115	%M00115		
9	ST_BOOL	%M00113	%M00113		
10	LD_BOOL	%M00113	%M00113		
11	JMPC	LABEL0:			
12	LD_BOOL	alarm_high	%I00300		
13	ST_BOOL	%M00113	%M00113		
14	LDN_BOOL	%M00113	%M00113		
15	JMPC	LABEL3:			
16	LD_BOOL	ALW_ON	%S00007		
17					

Global							
Name	Type	Len	Address	Des...	Stor...
alarm_low	Word	1	%I00225			Global	
alarm_high	Bit	1	%I00300			Global	✓

The IL Editor contains the following columns/fields:

- **Label:** Displays a label that can be referenced by a JUMP instruction.
- **Instruction:** Displays the function name. Instructions are entered by clicking on the Instruction field and then typing or selecting from the drop-down list.
- **Operand:** Displays the variables or constants used by the instruction. Operands are entered by clicking on the field and then typing or selecting from the drop-down list. This list only displays variables appropriate to this type of instruction.
- **Reference Address:** Displays the memory location of the operand.
- **Value:** The actual value of the operand in the PLC.
- **Comment:** Displays an optional comment about the instruction.

Customizing the IL Editor Display

You can customize font selection and color for the IL Editor. Perform the following steps to customize the display:

1. From the Folder Browser, click the Tools menu and select Options. The Options dialog box will appear. Select the Display tab.

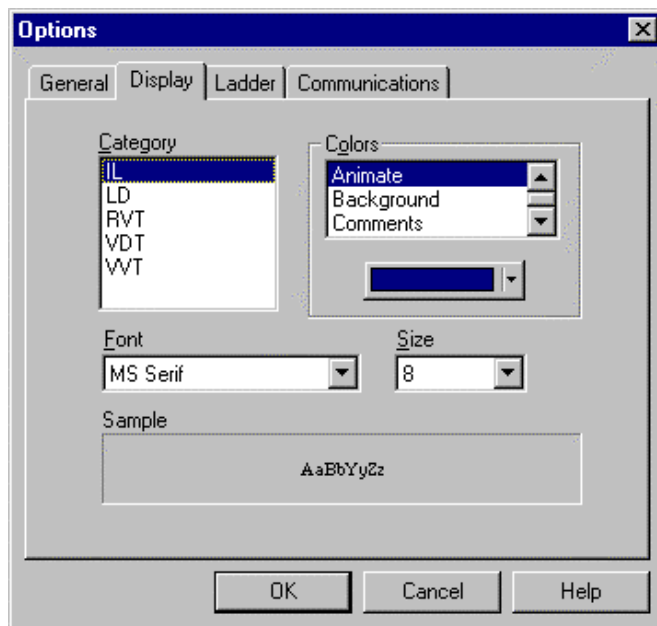

2. You can change the font selection and change the colors used for the display of online values (animate), background display color and color used to display comments.
3. Make the desired changes. Click OK to accept.

Entering Instructions and Instruction Parameters

This section describes how to enter and modify IL logic. Instructions consist of program elements to perform Boolean logic and execute functions such as timers, math functions and other functions. Variables and constants are assigned as operands for the instruction.

Selecting the Instruction

Instructions are selected directly in the IL Editor window. To add a new instruction or change an existing instruction, perform the following steps:

1. Select the location where you want to add a new instruction or modify an existing instruction.
2. Double-click the cell. The Instruction combo-box will appear, as shown below.

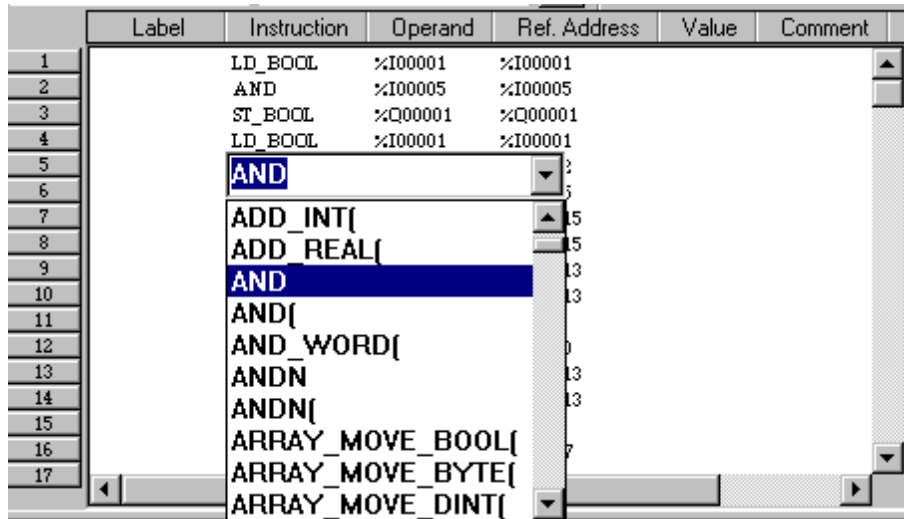

3. Select the instruction. Functions are identified as FUNCTION_NAME{. If a function is selected, parameters will appear between the brackets framing the function block.
4. The new instruction is inserted into the IL program.

Completing Address and Length Information

Certain instructions require you to supply a length (for example, a Move Instruction) or an address (for example, a Timer Instruction) for the instruction to operate. Instructions which require this information will show a Length or Address field in the Instruction column as shown below. Simply enter a length or address, as appropriate.

Label	Instruction	Operand
	ST_BOOL	%M00113
LABEL8:		
LABEL2:	MOVE_INT(IN := Length := Q =>)	
	TMR_HUND	
	Address	
	PV :=	

The MOVE_INT instruction requires a length to operate correctly.

The TMR_HUND instruction requires an address to operate correctly.

Completing Instruction Parameters

After an instruction is added to the program, you need to assign a variable or constant to each instruction operand. This section describes how to complete instruction operands in one of the following ways:

- Assign an existing variable to an operand
- Creating a new variable for an operand
- Assigning a constant value to an operand

Assigning Variables to Instruction Operands

Variables can be assigned to instruction operands. Variables may be Local Scope (local to the block) or Global Scope (Global to all blocks in the folder). The default scope for variables is Global Scope.

You may assign an existing variable or create a new variable for the instruction operand. This section describes how to assign variables to parameters using the mouse and the keyboard.

To assign an existing variable using keyboard entry:

1. Use the arrow keys to position the cursor on the operand where you want to assign a variable.
2. Type or select the variable as follows:
 - To select a variable from the list of defined variables, press Enter. The variable combo-box will appear. Use the up and down arrow keys to display the variables. When you find the variable you want to use, press Enter to accept.
 - To enter a variable by name, simply type the variable name. Press Enter to accept.

To assign an existing variable using the mouse:

1. Double-click on the operand where you want to assign a variable. The variable combo-box will appear.
2. To expand the variable list, click the arrow on the combo-box. Use the slide control to scroll up and down through the list.
3. Select the variable from the list. Press Enter, or click outside the operand area to accept.

To create a new variable for an instruction operand

1. Select the instruction operand using the keyboard or mouse
 - **Keyboard Select:** Use the arrow keys to position the cursor on the operand where you want to assign a variable. Press Enter. The variable combo-box will appear.
 - **Mouse Select:** Double-click the operand. The variable combo-box will appear.
2. Type a variable name, reference address and scope (optional) into the edit box using the following guidelines. (Fields must be separated by commas.)

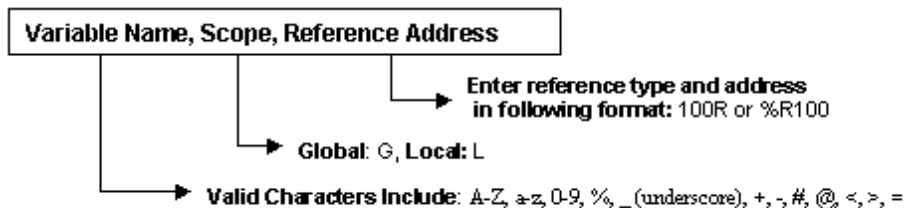

- The following example shows creating a variable "p1_count" for parameter IN of the MOVE_INT Function.

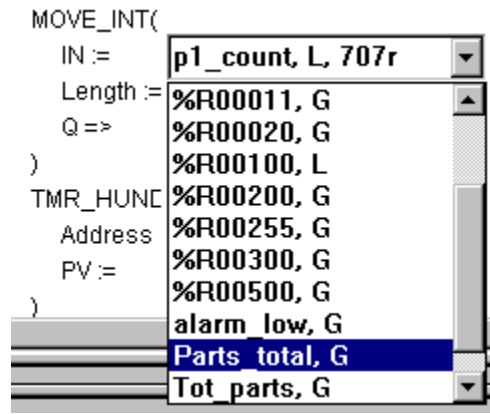

3. To accept the variable, press the Enter key – or use the mouse to click off the active cell.

Assigning Constants to Instruction Operands

Constants can be assigned to instruction operands.

To assign a constant using keyboard entry:

1. Use the arrow keys to position the cursor on the instruction operand where you want to assign a constant.
2. Type the constant value. Press the Enter key.

Rules on constants

A constant's value may not exceed the capacity of the operand and must be entered in a format consistent with the instruction type.

Format	Prefix	Example
Decimal (default)	None	43
Real	None	43.72
Scientific	None	6.93e4
Binary	2#	2#11110000
Octal	8#	8#730
Hexadecimal	16#	16#dc4b



Using Cut, Copy, Paste and Delete in the IL Editor

In the IL Editor, you can cut or copy row(s) or cell(s) from one portion of Instruction List logic to another portion, or from one block to another, without removing the variables included in those rungs or cells from the Variable Declaration Table.

You can also delete selected rungs or cells.

This section describes the different ways you can perform cut, copy, paste, and drag-and-drop in the IL Editor window.

To cut or copy in the IL Editor:

1. Open the IL block you want to edit. Select row(s) or cell(s) you want to copy or cut.
2. Choose Cut or Copy from the Edit or right mouse menu, click the Cut  or the Copy  button on the Standard toolbar, or press Ctrl+C to Copy or Ctrl+X to Cut. The selected information is cut or copied to the Clipboard.

Note: You can only copy a part of a multi-row instruction as text. If you copy a single row of a multi-row instruction, the selection cannot be pasted back into VersaPro.

To cut or copy in the IL Editor using Drag and Drop:

1. Open the IL block you want to edit. Select row(s) or cell(s) you want to copy or cut.
2. **To Cut** (using drag and drop), position the mouse arrow over the selected logic, press down and hold down the primary mouse button.

To Copy (using drag and drop), position the mouse arrow over the selected logic, press and hold the CTRL key, then press and hold the primary mouse button.

3. Move the logic to the appropriate area. To drop the selection, release the mouse button and/or the Ctrl key.

To copy as tab-delimited text for pasting into another application:

1. Open the IL block you want to edit. Select row(s) or cell(s) you want to copy.
2. Select the Edit menu and choose Copy as Text.
3. The selected information is copied as tab-delimited text, and becomes available for pasting into any application that accepts tab-delimited text.

Instruction List Operation

The IL programming language is an Accumulator based language. The instructions executed by the IL program modify or use an Accumulator that is located in PLC memory. The Accumulator also has a Type associated with it that has been set by an operator or Function call.

The operators that can be used in an IL program are listed in the following table. Since IL is an accumulator-based programming language, the operators work directly on the Accumulator. Comparison operators have a Boolean (1 or 0) result depending upon the result of the operation. Operands for IL instructions can be in the form of Variables, References, or Constants. Operators and Functions are unconditionally executed when encountered in the IL program. That is, an instruction is executed regardless of the result of a previous instruction.

The LD* (Load) operators are used to set the contents of the accumulator to the value of the variable or constant specified by the operand. The LD operators also set the Type of the accumulator. The ST* (Store) operators are used to set the value of the variable specified by the operand to the contents of the accumulator. The remainder of the operators manipulate the contents of the accumulator or perform an action based on the accumulator's value. For the Math and Relational operators, the type of the accumulator must be Integer.

Operator	Operand	Description / Affect upon Accumulator
LD_BOOL	Discrete Variable or Ref Address	Accumulator := Boolean Variable Load the contents of the Boolean variable into the Accumulator. Accumulator Type set to Boolean.
LDN_BOOL	Discrete Variable or Ref Address	Accumulator := NOT Variable Load the negative contents of the Boolean variable into the Accumulator. Accumulator Type set to Boolean.
LD_INT	Variable, Ref Address, or constant	Accumulator := Integer Variable Load the contents of the Integer variable into the Accumulator. Accumulator Type set to Integer.
LD_ENO	None	Accumulator := Boolean ENO Load the contents of the ENO (Enable Output) from the last Function or Function Block call into the Accumulator. Accumulator Type set to Boolean.
ST_BOOL	Discrete Variable or Ref Address	Variable := Boolean Accumulator Store the contents of the Boolean Accumulator to the Boolean variable. Accumulator value and Type are unchanged (Boolean).
STN_BOOL	Discrete Variable or Ref Address	Variable := NOT Boolean Accumulator Store the negative contents of the Boolean Accumulator

		to the Boolean variable. Accumulator value and Type are unchanged (Boolean).
ST_INT ST_DINT ST_REAL ST_WORD	Variable or Ref Address	Variable := Integer Accumulator Variable := Double Integer Accumulator Variable := Real Accumulator Variable := Word Accumulator Store the contents of the Integer, Double Integer, Real, or Word Accumulator to the variable. Accumulator value and Type are unchanged.
S	Discrete Variable or Ref Address	Set Coil Variable := Boolean Accumulator Store the contents of the Boolean Accumulator to the Set Coil Boolean variable. Accumulator value and Type are unchanged (Boolean).
R	Discrete Variable or Ref Address	Reset Coil Variable := Boolean Accumulator Store the contents of the Boolean Accumulator to the Reset Coil Boolean variable. Accumulator value and Type are unchanged (Boolean).
NT	Discrete Variable or Ref Address	Negative Transition Variable := Boolean Accumulator Store the contents of the Boolean Accumulator to the Negative Transition Coil Boolean variable. Accumulator value and Type are unchanged (Boolean).
PT	Discrete Variable or Ref Address	Positive Transition Variable := Boolean Accumulator Store the contents of the Boolean Accumulator to the Positive Transition Coil Boolean variable. Accumulator value and Type are unchanged (Boolean).
NOT	None	Accumulator := NOT Accumulator Invert the Boolean state of the Accumulator. Accumulator Type unchanged (Boolean).
AND ANDN AND(Discrete Variable or Ref Address	Accumulator := Accumulator AND Boolean Variable Accumulator := Accumulator AND NOT Boolean Variable Accumulator := Accumulator AND Boolean expression Accumulator Type unchanged (Boolean).
OR ORN OR(Discrete Variable or Ref Address	Accumulator := Accumulator OR Boolean Variable Accumulator := Accumulator OR NOT Boolean Variable Accumulator := Accumulator OR Boolean expression Accumulator Type unchanged (Boolean).
XOR XORN	Discrete Variable or Ref Address	Accumulator := Accumulator XOR Boolean Variable Accumulator := Accumulator XOR NOT Boolean Variable Accumulator Type unchanged (Boolean).
ADD	Variable, Ref Address, or Constant	Accumulator := Accumulator + operand Accumulator Type unchanged (Integer).
SUB	Variable, Ref Address, or Constant	Accumulator := Accumulator - operand Accumulator Type unchanged (Integer).
MUL	Variable, Ref Address, or Constant	Accumulator := Accumulator * operand Accumulator Type unchanged (Integer).
DIV	Variable, Ref Address, or Constant	Accumulator := Accumulator / operand Accumulator Type unchanged (Integer).

MOD	Variable, Ref Address, or Constant	Accumulator := Accumulator MOD operand Accumulator Type unchanged (Integer).
GT	Variable, Ref Address, or Constant	Accumulator := (Accumulator > operand) Accumulator Type set to Boolean.
GE	Variable, Ref Address, or Constant	Accumulator := (Accumulator >= operand) Accumulator Type set to Boolean.
EQ	Variable, Ref Address, or Constant	Accumulator := (Accumulator = operand) Accumulator Type set to Boolean.
NE	Variable, Ref Address, or Constant	Accumulator := (Accumulator != operand) Accumulator Type set to Boolean.
LE	Variable, Ref Address, or Constant	Accumulator := (Accumulator <= operand) Accumulator Type set to Boolean.
LT	Variable, Ref Address, or Constant	Accumulator := (Accumulator < operand) Accumulator Type set to Boolean.
RET RETC RETCN	None	Unconditional Return from Block Return from Block if Boolean Accumulator has value of 1 Return from Block if Boolean Accumulator has value of 0
JMP JMPC JMPCN	Label	Unconditional Jump to label Jump to label if Boolean Accumulator has value of 1 Jump to label if Boolean Accumulator has value of 0
CAL CALC CALCN	Subroutine Name	Unconditional Call Block Call Block if Boolean Accumulator has value of 1 Call Block if Boolean Accumulator has value of 0
FUNC_NAME(IN1:= IN2:= Q2=>)	Variable, Ref Address, or Constant, dependent upon type of the function parameters.	Call built-in PLC Function. Accumulator value and Type are set to value and type of Output parameter Q1, if it exists.
)		End of Boolean nested operation. Accumulator value and Type are unchanged (Boolean).

Constants

The IL editor supports the following constants for use as operands : Integer, Real, Real with exponents, Base 16 (16#xxxx), Base 8 (8#xxx), and Binary (2#xxxxxxxx). To use a Constant of 1 or 0 for an operand used with a Boolean operator, the ALW_ON (1 or TRUE) and ALW_OFF (0 or FALSE) System variables must be used.

Functions

Functions are invoked using formal input lists. Functions are also unconditionally executed, regardless of the result of a previous instruction. Functions usually place their result in the Accumulator. The type of the accumulator is also usually determined by the function.

```

                                ``AddResultGt100 := ((Sqrt_Int(Input1) > 100)
Sqrt_Int(
    IN:=      Input1      ``Input to Function call
)
GT          100
ST_BOOL    AddResultGt100 ``Set to TRUE if result greater than 100

```

Function Blocks

Function Blocks are also invoked using formal input lists. Function Blocks are also *unconditionally* executed, regardless of the result of a previous instruction. Function Blocks usually place their result in the Accumulator. The type of the accumulator is also usually determined by the function block. The Address of a Function Block is an input parameter.

```

UPCTR(
    Address :=  %R00022
    R      :=  %M00012
    PV     :=   1
)

```

PLC Built-in Functions and Function Blocks

The following PLC Built-in Functions and Function Blocks can be called by the IL program. The resulting Accumulator's value and Type are also specified for each function and function block. A Yes in the ENO column indicates that the function or function block sets the ENO (Enable Output) variable. The table also indicates whether the function or function block requires the accumulator to be initialized by placing an LD Bool instruction in front of the function block.

Function or Function Block	ENO	Requires LD Boolean Instruction	Resulting Accumulator Value and Type
Timers and Counters (Function Blocks)			
ONDTR_TENTHS	Yes	Yes	N/A
ONDTR_HUNDS	Yes	Yes	N/A
ONDTR_THOUS	Yes	Yes	N/A
TMR_TENTHS	Yes	Yes	N/A
TMR_HUNDS	Yes	Yes	N/A
TMR_THOUS	Yes	Yes	N/A
OFDT_TENTHS	Yes	Yes	N/A
OFDT_HUNDS	Yes	Yes	N/A
OFDT_THOUS	Yes	Yes	N/A
UPCTR	Yes		N/A
DNCTR	Yes		N/A
Standard Math (Functions)			
ADD_INT	Yes		Output Parameter Q, Integer
ADD_DINT	Yes		Output Parameter Q, Double Integer
ADD_REAL	Yes		Output Parameter Q, Real
SUB_INT	Yes		Output Parameter Q, Integer
SUB_DINT	Yes		Output Parameter Q, Double Integer
SUB_REAL	Yes		Output Parameter Q, Real
MUL_INT	Yes		Output Parameter Q, Integer
MUL_DINT	Yes		Output Parameter Q, Double Integer
MUL_REAL	Yes		Output Parameter Q, Real
DIV_INT	Yes		Output Parameter Q, Integer
DIV_DINT	Yes		Output Parameter Q, Double Integer
DIV_REAL	Yes		Output Parameter Q, Real
ADD_INT	Yes		Output Parameter Q, Integer
ADD_DINT	Yes		Output Parameter Q, Double Integer
ADD_REAL	Yes		Output Parameter Q, Real
MOD_INT	Yes		Output Parameter Q, Integer
MOD_DINT	Yes		Output Parameter Q, Double Integer

Function or Function Block	ENO	Requires LD Boolean Instruction	Resulting Accumulator Value and Type
SQRT_INT	Yes		Output Parameter Q, Integer
SQRT_DINT	Yes		Output Parameter Q, Double Integer
SQRT_REAL	Yes		Output Parameter Q, Real
Trig Functions (Functions)			
SIN	Yes		Output Parameter Q, Real
COS	Yes		Output Parameter Q, Real
TAN	Yes		Output Parameter Q, Real
ASIN	Yes		Output Parameter Q, Real
ACOS	Yes		Output Parameter Q, Real
ATAN	Yes		Output Parameter Q, Real
Logarithmic/Exponential Functions (Functions)			
LOG	Yes		Output Parameter Q, Real
LN	Yes		Output Parameter Q, Real
EXP	Yes		Output Parameter Q, Real
EXPT	Yes		Output Parameter Q, Real
Radian Conversion Functions (Functions)			
RAD_2_DEG	Yes		Output Parameter Q, Real
DEG_2_RAD	Yes		Output Parameter Q, Real
Relational Functions (Functions)			
EQ_INT	No		Output Parameter Q, Boolean
EQ_DINT	No		Output Parameter Q, Boolean
EQ_REAL	No		Output Parameter Q, Boolean
NE_INT	No		Output Parameter Q, Boolean
NE_DINT	No		Output Parameter Q, Boolean
NE_REAL	No		Output Parameter Q, Boolean
GT_INT	No		Output Parameter Q, Boolean
GT_DINT	No		Output Parameter Q, Boolean
GT_REAL	No		Output Parameter Q, Boolean
GE_INT	No		Output Parameter Q, Boolean
GE_DINT	No		Output Parameter Q, Boolean
GE_REAL	No		Output Parameter Q, Boolean
LT_INT	No		Output Parameter Q, Boolean
LT_DINT	No		Output Parameter Q, Boolean
LT_REAL	No		Output Parameter Q, Boolean
LE_INT	No		Output Parameter Q, Boolean
LE_DINT	No		Output Parameter Q, Boolean
LE_REAL	No		Output Parameter Q, Boolean
Relational Functions (Functions)			
RANGE_INT	No		Output Parameter Q, Boolean

Function or Function Block	ENO	Requires LD Boolean Instruction	Resulting Accumulator Value and Type
RANGE_DINT	No		Output Parameter Q, Boolean
RANGE_WORD	No		Output Parameter Q, Boolean
Bit Functions (Functions)			
AND_WORD	Yes		Output Parameter Q, Word
OR_WORD	Yes		Output Parameter Q, Word
XOR_WORD	Yes		Output Parameter Q, Word
NOT_WORD	Yes		Output Parameter Q, Word
Bit Functions (Functions)			
SHL_WORD	No		Output Parameter B2, Boolean
SHR_WORD	No		Output Parameter B2, Boolean
ROL_WORD	Yes		N/A
ROR_WORD	Yes		N/A
BTST_WORD	No		Output Parameter Q, Boolean
BSET_WORD	Yes		N/A
BCLR_WORD	Yes		N/A
BPOS_WORD	Yes		Output Parameter POS, Integer
MSKCMP_WORD	No		Output Parameter MC, Boolean
MSKCMP_DWORD	No		Output Parameter MC, Boolean
Data Move Functions (Functions)			
MOVE_BOOL	Yes		N/A
MOVE_INT	Yes		N/A
MOVE_WORD	Yes		N/A
MOVE_REAL	Yes		N/A
Data Move Functions (Functions)			
BLKMOV_INT	Yes		N/A
BLKMOV_WORD	Yes		N/A
BLKMOV_REAL	Yes		N/A
BLKCLR_WORD	Yes		N/A
SHFR_BIT	Yes	Yes	N/A
SHFR_WORD	Yes	Yes	N/A
COMM_REQ	No		Output Parameter FT, Boolean
Data Move Function Blocks (Functions)			
BIT_SEQ	Yes	Yes	N/A
Table Functions (Functions)			
ARRAY_MOVE_INT	Yes		N/A
ARRAY_MOVE_DINT	Yes		N/A
ARRAY_MOVE_BIT	Yes		N/A
ARRAY_MOVE_BYTE	Yes		N/A
ARRAY_MOVE_WORD	Yes		N/A
SRCH_EQ_INT	Yes		N/A
SRCH_EQ_DINT	Yes		N/A

Function or Function Block	ENO	Requires LD Boolean Instruction	Resulting Accumulator Value and Type
PID_ISA			
New Series 90-30 (36x) Function Blocks (Function Blocks) SER	Yes	Yes	N/A
VersaMax Release 1.1 and later Function Blocks DRUM SCALE_INT SCALE_WORD	Yes Yes Yes	Yes	Output Parameter Q, Word Output Parameter OUT, Integer Output Parameter OUT, Word

Nesting of Boolean Expressions

The user can nest Boolean expressions using the **AND(** and **OR(** operators up to a nesting level of 8. When a nested Boolean expression is started with an **AND(** or **OR(** operator, the next instruction must be a **LD_BOOL** or **LDN_BOOL** operator. The only operators that are allowed within a nested Boolean expression are : **S**, **R**, **ST_BOOL**, **STN_BOOL**, **NT**, **PT**, **NOT**, **AND***, **OR***, and **XOR***. Nested Boolean expressions can be used to evaluate complex Boolean equations. A sample nested Boolean expression is as follows :

```

LD_BOOL      %I00001      %I00001
AND(
LD_BOOL      %I00002      %I00002
OR           %T00010      %T00010
AND         %T00011      %T00011
OR(
LD_BOOL      %T00032      %T00032
OR           %T00033      %T00033
ST_BOOL      %M00077      %M00077
ANDN         %T00088      %T00088

)
AND         %T00088      %T00088
OR         %Q00067      %Q00067

)
ST_BOOL      %T00099      %T00099

```

No control instructions or function calls may be placed within nested Boolean expression.

Using ENO

When a function or function block is executed, its ENO output is used to indicate the successful execution of the function block. If an error occurs when the function is executed, it will set or reset the ENO output. The user can check the status of the ENO output by using the LD_ENO operator to load the ENO output value into the Accumulator. The user can then examine this value for error handling.

```

"Calculate the following expression
  %R00005 := (%R00001 + 100) * %R00077
  Set calcOK variable to 1 if calculation successful
  
```

```

ADD_DINT(
  IN1 :=      %R00001      %R00001
  IN2 :=      100
)
ST_DINT      %R00003      %R00003
LD_ENO                               "LD_ENO used to get ENO output of ADD_DINT
JMPCN      error:
MUL_DINT(
  IN1 :=      %R00003      %R00003
  IN2 :=      %R00077      %R00077
)
ST_DINT      %R00005      %R00005
LD_ENO                               "LD_ENO used to get ENO output of MUL_DINT
JMPCN      error:
LD_BOOL     ALW_ON      %S00007
ST_BOOL     calcOK      %Q00077 "calcOK := 1
RET
error:
LD_BOOL     ALW_OFF     %S00008
ST_BOOL     calcOK      %Q00077 "calcOK := 0
RET
  
```

Defining Temporary Variables

When programming in Instruction List, the user must define the memory locations to be used by the IL Accumulator. The user must define 8 consecutive discrete points in %T, %M, or %Q memory for use as the Boolean Accumulator. The user must also define 2 words of reference memory in %AI, %AQ, or %R memory for use as the Word, Integer, Double Integer, and Real Accumulator. The user defines the IL Temporary Variables using the Folder Properties dialog. Once these temporary variables have been defined, these references may not be referenced directly in the program.

Error Checking

The following error checking is performed on the IL program when it is compiled.

1. The type of the Accumulator must be compatible with the type of the operator.
2. A LD instruction or Function call must occur before a ST instruction.
(Accumulator must have a Value and Type.)
3. Parenthesis of nested expressions must be matched.
4. Reference Types must be correct for operators. For example, can't do a "S %R00001" since data type must be bit.
5. JMPs and MCRs must have matching labels.
6. All variables must be defined.
7. CALs must have matching IL/LD Blocks.
8. Reference Addresses must be within the limits of the configured CPU.
9. Function and Function Block parameters must be the correct memory types and values.

Chapter 6

Working with the Variable Declaration Table

The Variable Declaration Table (VDT) is the window used to create, edit and view variables online. The VDT usually displays automatically when the Folder Browser is open. If the VDT is not displaying from the Folder Browser, select the View menu and select Variable Declaration Table, or click the Variable Declaration Table toolbar button



This chapter introduces you to variables and describes how to create variables for use in your LD and IL programs.

Chapter Contents

- An overview of the Variable Declaration Table (VDT)
- An introduction to variables
- How to create and edit variables
- How to work with variables using standard cut, copy and paste commands
- How to delete variables and compact and save the VDT
- How to import and export variables to and from SNF Files

Overview of the Variable Declaration Table

The Variable Declaration Table is organized into tabs. Each tab displays variables as described below:

Global Tab: Displays all Global variables.

Local Tab: Displays variables local to the active block. If no block is open the Local tab is blank.

All Tab: Displays all variables, Global and Local.

System Tab: Displays System variables. These variables are not editable, but they can be used in logic.

Temporary Tab: Displays variables created in the Folder Properties dialog box for temporary use in the IL Editor. Temporary variables are not editable.

A sample Variable Declaration Table is shown below.

Name	Type	Len	Address	Description	Stored Value	Scope	Ret	Ovr	Ext
%I00081	Bit	1	%I00081		0	Global	✓		
%Q00019	Bit	1	%	Variable Scope Global variables may be used on all blocks. Local variables may be used only in the block where the variable is defined.		Global	✓		
%Q00051	Bit	1	%		Global	✓			
%I00082	Bit	1	%		Global	✓			
%Q00020	Bit	1	%		Global	✓			
%Q00052	Bit	1	%		Global	✓			
%I00083	Bit	1	%		Global	✓			
%Q00001	Bit	1	%Q00001			Global	✓		
%I00084	Bit	1	%I00084			Global	✓		
%Q00017	Bit	1	%Q00017			Global	✓		
%I00085	Bit	1	%I00085			Global	✓		
%Q00018	Bit	1	%Q00018			Global	✓		
%Q00050	Bit	1	%Q00050			Global	✓		
	Bit	1	%I00086			Global	✓		
	Bit	1	%Q00013			Global	✓		
	Bit	1	%I00087			Global	✓		
	Bit	1	%Q00014			Global	✓		
%I00088	Bit	1	%I00088			Global	✓		

VDT Tabs
Click a tab to view variables at a different scope

Global Local All System Temporary

Variable Table Field Descriptions

This section describes the fields which are included when defining a variable.

Name

In variable programming, names are assigned to memory addresses. You can assign a logical name, or let the reference address match the variable name. If you do not assign a name for the variable, the reference address is automatically used as a name. A variable name can be no longer than 31 characters, and may only consist of the characters A - Z, a - z, 0 - 9, _, +, -, #, @, <, >, =. Variable names must start with a letter or underscore ("_"). For a list of reserved words, see page 6-4.

Type

Each variable must be assigned a data type describing how the variable is to be used in the program. VersaPro allows you to assign a variable a Bit, Byte, or Word data type.

Length

The Length field specifies the amount of data that a variable is to use. For word data type, length specifies the number of words. For Byte data type, it specifies the number of bytes. For bit data type, the length must be 1. The Data Length defines the amount of Stored Value Data that is specified for a variable.

Address

A reference address links a variable with a physical location in the PLC.

Description

The Description field allows you to enter descriptive information about a variable. The field is optional and may be left blank. Descriptions can be no longer than 64 characters.

Stored Value

Any initial value specified for a variable in the Variable Declaration Table is transferred to the PLC upon program transfer, even if the variable is not used in the program. Such values are considered an attribute of the variable. You can specify as much information per variable as the Reference Table will hold.

Scope

Scope defines the areas where a variable can be used in a folder. The possible values for scope are "Global" and (for each block in the folder) "Local: <block name>". System variables are pre-defined for use by the PLC CPU.

Retentive

The Retentive field specifies whether or not the selected variable retains its value after loss of power. The retentive state shown in the VDT initializes the variable when stored. It does not show the current retentive state as logic is running. VersaPro requires that the retentive state be checked for all memory areas except %M, %Q, and %T. Row validation automatically corrects any incorrect settings for all but these areas.

Overrides

Overrides are tools for program checking and maintenance. You can test a program in a PLC that is not connected to I/O hardware by using overrides to simulate inputs. You can also check a program when I/O hardware is connected by using overrides to prevent coil operation. Overrides can temporarily bypass a failed input device so that machine operation can continue until the device can be repaired. However, using overrides in this manner can cause the overriding of safety devices and is not recommended. The override state shown in the VDT initializes the variable when stored values or overrides are stored. It does not show the current override state as a program is running. Override may only be checked on a non-system bit variable assigned to %G, %I, %M, or %Q.

EXT

When the EXT (show externally) field is selected, the variable can be shared by other applications.

Reserved Words

In addition to function block names, the following words are reserved and may not be used as variable, program, block, label, or task names:

AUX	LPT1
CLOCK\$	LPT2
COM1	LPT3
COM2	LPT4
COM3	LPT5
COM4	LPT6
COM5	LPT7
COM6	LPT8
COM7	LPT9
COM8	NUL
COM9	PRN
CON	

Creating and Modifying Variables

VersaPro allows you to create and modify variables for use in program logic. Variables can have different data types, scopes, lengths, and addresses. Several variables can reference the same address, and you can associate descriptions and initial stored values with any variable. VersaPro allows you to create and modify variables on the fly or prior to program construction.

System Variables (%S, %SA, %SB, %SC) cannot be edited. They are present in the variable list whenever a new folder is created.

Modifications that you make to variables in the Variable Declaration Table are reflected at all reference points including program logic.

Note: Declaration of variables with overlaps, for example a variable at %R8 with length 3 and a variable at %R10 of length 2 have an overlap at %R10, will result in stored value conflicts when you attempt to Store the stored values to the PLC. In order to resolve these conflicts, you must use the VDT to relocate variables so that they do not overlap.

To create a new variable or modify an existing variable in the VDT:

1. From the Folder Browser, double click on the Variable Declarations icon. The cursor will become active in the Variable Declaration Table
2. Perform the following steps to create or edit:
 - To create a new variable, click the right mouse button and choose Insert Row. A new row will appear in the VDT.
 - To edit an existing variable, locate the variable and double click on the fields you want to edit.

Global Local All System Temporary									
	Name	Type	Len	Address	Description	Stored Value	Scope	Ret	Ovr
<input type="checkbox"/>	%R00100	Word	1	%R00100			Local_MAIN	✓	
<input type="checkbox"/>	Tot_parts	Word					Global	✓	

3. For new variables, complete the Name, Type and Address fields. Verify Scope and Length. You may also enter a Description and Stored Value, if desired. To modify existing variables, change the parameters as required in your application:
 - VersaPro will display message boxes if the variable definition is incomplete, or (for modified variables) does not pass validation.

Navigating in the VDT

VersaPro allows you to navigate using either the mouse or the keyboard. You can also navigate to a particular variable using the Go to Variable dialog box or the Edit Variable menu item.

Navigating Using the Mouse or Keyboard

To navigate using the mouse:

Move the mouse arrow to the cell that you want to edit, then click the primary mouse button. As with keyboard navigation, if you're editing a cell, moving the selection implies accepting the data in the cell from which you are moving.

To navigate using the keyboard:

Reference the following table to navigate through the VDT using the keyboard.

Key	Action
Arrow Keys	<p>If the current cell has not been selected for editing (if the cell, but not the text, is highlighted);, the arrow keys move the selection one cell in the direction of the arrow key.</p> <p>If the current cell has been selected for editing;., the Left and Right arrow keys move the cursor to the left or right in the cell until the beginning or end of the text is reached</p> <p>Moving from one row to another, by using up/down or right/left arrow keys, always triggers row validation.</p>
Enter	<p>If the current cell has not been selected for editing (if the cell, but not the text, is highlighted), the Enter key selects the cell for editing.</p> <p>If the current cell has been selected for editing, the Enter key submits the contents of the cell for row validation, and selects the cell below the current one.</p>
F2	Selects or unselects the current cell for editing.
Shift + Arrow Keys	<p>If the current cell has not been selected for editing (if the cell, but not the text, is highlighted), the Shift + Arrow keys select the current cell and moves the selection one cell in the direction of the arrow key.</p> <p>If the current cell has been selected for editing, the keys select the current character and moves the selection one character in the direction of the arrow key.</p>
Shift + Space Bar	Selects the current row.
Home	<p>If the current cell has not been selected for editing (if the cell, but not the text, is highlighted), the Home key selects the first cell in the current row.</p> <p>If the current cell has been selected for editing, the Home key moves the cursor to the left of the first character in the cell.</p>

End	If the current cell has not been selected for editing (if the cell, but not the text, is highlighted), the End key selects the last cell in the current row. If the current cell has been selected for editing, the End key moves the cursor to the right of the last character in the cell.
Ctrl + Home	Selects the first cell in the first row.
Ctrl + End	Selects the first cell in the last row.
Tab	If the current cell has not been selected for editing (if the cell, but not the text, is highlighted), the Tab key selects the next cell to the right. If the current cell has been selected for editing, the Tab key submits the contents of the cell for row validation, and selects the next cell to the right. Note: Moving from one row to another, by tabbing left from the leftmost cell or right from the rightmost, always triggers row validation.
Shift + Tab	If the current cell has not been selected for editing (if the cell, but not the text, is highlighted), the Shift + Tab keys select the next cell to the left. If the current cell has been selected for editing, the Shift + Tab keys submits the contents of the cell for row validation, and selects the next cell to the left. Note: Moving from one row to another, by tabbing left from the leftmost cell or right from the rightmost, always triggers row validation.
Ctrl + Tab	Displays the next VDT tab (Local, Global, All, System) to the right.
Page Down/Up	Moves the display one vertical viewable page down/up, and selects the cell in the same relative x,y position as before the movement.

Locating a Variable using the Go To Variable Dialog Box

You can quickly locate variables using the Go To Variable dialog box. Perform the following steps to locate a variable by name.

1. From the Variable Declaration Table, click the right mouse button and choose Go to Variable. The Go to Variable dialog box will appear.

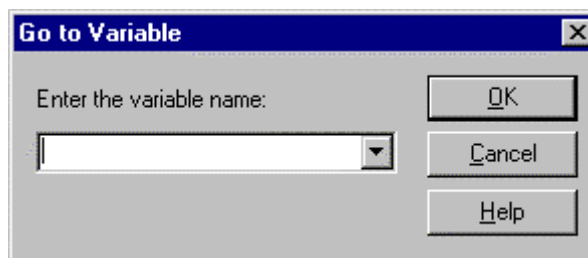



2. Enter the name of the variable that you want to go to, or select it from the drop-down list.
3. Click OK. The variable that you entered becomes selected in the Variable Declaration Table.

Using Cut, Copy, Paste and Drag and Drop in the VDT

VersaPro allows you to cut or copy and then paste variables or cells in single or multiple variables within the Variable Declaration Table without removing ladder elements from ladder logic or instructions from instruction list logic. It also allows you to paste items placed on the clipboard by applications other than VersaPro into the Variable Declaration Table, and to cut or copy items to the clipboard for pasting to any other application that accepts tab-delimited text. Pasting overwrites any information in a cell or variable.

VersaPro also allows you to drag and drop -cut or -copy within the VDT, or from the Variable Declaration Table to either editor. Dropping in the VDT overwrites any information in a cell or variable.

To cut, copy and paste in the Variable Declaration Table:

1. Open the Variable Declaration Table Select a variable(s) or cell(s) within single or multiple variables.
2. Choose Cut or Copy from the Edit menu, click the Cut button  or the Copy button  on the toolbar, or press Ctrl + C for Copy or Ctrl + X for Cut. To select a variable, every field in the variable must be selected. The selected data is cut or copied to the clipboard. It is now available for pasting to any other application that accepts tab-delimited text.
3. Select the variable(s) or cell(s), to which you wish to paste the information that you've cut or copied. Information on the clipboard that originated in another application may also be pasted to VersaPro.
4. Choose Paste from the Edit menu, click the Paste button , or press Ctrl + V. Row validation is performed on each variable to check for global scope conflicts with existing variables before pasting to the VDT. If a variable fails row validation, an error message appears, and then a dialog box appears allowing you to correct errors appears. If the problem is corrected, row validation continues for other variables. If the information on the clipboard is valid for pasting in VersaPro and the number of variables or cells corresponds to the area that you've highlighted, the information is pasted.

Details on Cutting and Copying

- If every cell in a variable is selected and a cut is performed, the variable is deleted from the folder.
- Vertical gaps between non-contiguous variables are deleted when the variables are copied to the clipboard.
- Rows on the clipboard are separated by a CR/LF. Columns are separated by tabs. These separations become obvious when pasting to an external application.
- If a cut or copied variable's length is greater than 1, its stored values are separated by commas when pasted to external applications (like Microsoft Excel®).
- When cut or copied to the clipboard, Retentive and Override values are stored as 1 for True and 0 for False.
- It is not possible to make non-contiguous row selections with the keyboard.
- The following fields cannot be cut from a variable: Type, Length, Scope, Retentive, Override.

Details on Pasting

- If more variables reside on the clipboard than have been selected to be overwritten, the selected variables are overwritten and the remaining clipboard variables are inserted on to the table(s)
- If fewer variables reside on the clipboard than have been selected to be overwritten, as many of the selected variables as possible are overwritten, and the rest are deleted.
- Nothing may be pasted into the System tab.
- Nothing may be pasted into the Temporary tab.
- If a variable is pasted onto the Global table, it becomes a global variable regardless of its original scope.
- If a variable is pasted onto a Local table, it becomes local to that block regardless of its original scope.
- If a global variable is pasted onto the All table, it remains global.
- If a local variable is pasted onto the All table, the program will attempt to assign it to its defined block. If that block does not exist in the folder, it will be made a global variable.
- Any values changed by a paste operation on the visible table will also be changed on any other table where they appear.
- Values that have been altered by a paste in the VDT are also altered in the IL and LD program logic displays.

- For cells, if the selected area is smaller than the area on the clipboard, an error message appears and the paste is aborted. If the selected area is larger than the area on the clipboard, the cut or copied information is pasted in the upper left corner of the selected area.
- Any text may be pasted into a free floating or line comment.
- For rows, if the selected number of rows is smaller than the number on the clipboard, an error message appears and the paste is aborted. If the selected number of rows is greater than the number on the clipboard, the extra rows are deleted. If only a cell is selected, the rows are pasted above that cell.

To drag and drop-cut in the VDT:

1. Open the Variable Declaration Table.
2. Select a variable(s) or cell(s) within single or multiple variables.
3. Position the mouse arrow over the selected variable or cell.
4. Press and hold the primary mouse button.
5. Move the variable or cell to the appropriate area.
6. To drop the selection, release the mouse button. If it is valid in the new location, the selected variable or cell is removed from the original position and placed in the new position. If it is not valid, the drag and drop operation is cancelled.

To drag and drop-copy in the VDT:

1. Open the Variable Declaration Table.
2. Select a variable(s) or cell(s) within single or multiple variables.
3. Position the mouse over the selected variable or cell.
4. Press and hold the Ctrl key.
5. Press and hold down the primary mouse button.
6. Move the variable or cell to the appropriate area.
7. To drop the selection, release the mouse button. If it is valid in the new location, the selected variable or cell is copied from the original position and placed in the new position. If it is not valid, the drag and drop operation is cancelled.

Details on Dragging and Dropping in the VDT

- Changes to values that occur through Dragging and Dropping will also appear on any other affected table(s) or editors.
- Drag and drop of variables is only available on the same VDT tab.
- When a selection spans more than one variable, row validation is performed. If any cell in the selected area is invalid in its new location, the entire drag and drop operation is cancelled.
- You cannot cut the following cells, unless the entire row is selected: Type, Length, Scope, Retentive, Override
- If a selection is dropped that would go beyond the last row of the VDT, new rows are created to accommodate the drop.
- When a selection is dropped, it overwrites the existing cells.
- VersaPro does not allow dragging and dropping a discontinuous set of cells.

To drag and drop from the VDT to the LD or IL Editor:

1. Open a block in the IL or LD Editor.
2. Open the Variable Declaration Table.
3. Select a variable in the VDT.
4. Position the mouse over the selected variable.
5. Press and hold down the primary mouse button.
6. Move the variable to the Operand field of an existing instruction in the IL Editor, or to an element or operand in the LD Editor.
7. Release the mouse button to drop the variable. The variable becomes the operand for the selected instruction.

Details on Dropping a Variable into an Editor

- When a selection is dropped it overwrites the existing cell.
- Variables may only be dropped on existing elements or operands.
- If the variable is invalid in its new location, the entire drag and drop operation is cancelled.
- Multiple rows cannot be dragged and dropped from the VDT to the IL Editor. No more than one row from the VDT may be dropped into the LD Editor.

Variable Declaration Table Utilities

VersaPro provides several utilities to sort variables, delete variables as well as clear and save the VDT.

This section describes how to use the utilities supported by the VDT.

Sorting Variables

VersaPro allows you to sort variables in the VDT, in ascending or descending order, according to any but the Stored Value column.

To sort variables in the VDT

1. Open the Variable Declaration Table.
2. Select a column in the VDT, other than the Stored Value column, by clicking on its quick-select button. VersaPro does not allow sorting on the Stored Value column.
3. Choose Sort from the View menu, then choose Ascending or Descending from the submenu that appears, or choose Sort Ascending or Sort Descending from the Context-Sensitive Menu.

Deleting Variables and the Contents of a VDT

Variables can be deleted from the Variable Declaration Table without removing ladder elements from ladder logic or instructions from instruction list logic. Elements from which variables have been removed become unnamed.

VersaPro also allows you to delete the contents of a Variable Declaration Table (clearing the VDT). Performing such a deletion removes all the VDT's variables from the Global, Local, and All tabs and from program logic. The logic itself is not affected. The VDT remains in the folder and is always displayed in the Folder Browser; it can only be cleared, not deleted.

To delete a variable in the VDT

1. Open the Variable Declaration Table.
2. Select the variable or variables that you want to delete.
3. Choose Delete from the Edit menu or press the Delete key. The variable or variables are deleted from the VDT.
4. The variables are deleted from program logic.

- In Ladder Diagram blocks, the names of deleted variables are removed from elements, but the elements to which these variables had been assigned are not removed.
- In Instruction List blocks, the names of deleted variables are removed from the Operand column, and their addressees are removed from the Reference Address column, but the relays and instructions to which these variables had been assigned are not removed.

Note: In order for a single variable to be deleted, every field in the variable (the entire row) must be selected. If every field is not selected when the deletion is performed, the selected fields are cleared, but the variable remains in existence.

To clear the Variable Declaration Table

1. Highlight the Variable Declaration Table in the Folder Browser.
2. Choose Delete from the Edit or the Context-Sensitive menu, or press the Delete key. A confirmation message appears asking if you are sure you want to erase all variables from the program.
3. Click OK to delete all variables. Otherwise click Cancel.
 - All global and local variables are deleted from the VDT. No variables remain on the Global, Local, or All tables.
 - All variables are removed from program logic.
 - System variables remain on the System table. They can never be deleted.

Saving Edits in the VDT

To save the Declaration Table:

1. From the Variable Declaration Table, click the Save Folder button on the toolbar , choose Save from the File or the Context-Sensitive menu, or press Ctrl + S.
2. VDT data is saved.

Note: In a number of circumstances, for instance, when you close a folder or close the application, the VDT is saved automatically.

Compacting the VDT

When you edit the VDT by cutting, copying, pasting, or deleting, the VDT retains information about your edits. This edit history can cause the VDT to grow substantially in size. If a large amount of editing has taken place in a particular VDT, it is sometimes useful to remove the VDT's edit history and thereby lessen its size. The Compact option on the Folder menu allows you to do so.

To compact the VDT:

1. Open a folder.
2. Open the Variable Declaration Table.
3. Make the Variable Declaration Table active.
4. Choose Compact from the Folder menu.

The VDT is compacted.

Viewing the Highest References Used

To display a list of the highest references used for all memory types, select Highest References Used from the VDT context sensitive menu.

Finding Unused Variables

Unused variables are variables which have been created, but are not used in any program logic. From the Folder menu, select Find Unused Variables. The unused variables will be listed in the Information window by Name, Scope, and Address.

Creating a Cross-Reference Listing of Variables

From the Tools menu or the Folder browser CSM menu, select View Online Cross References. The Information window will display a list of all variables used in the selected block by reference type. The cross reference also lists each Rung and Instruction that uses the variable.

Importing and Exporting Variables

VersaPro allows you to import and export variables to external locations using a Shared Name File Format. This section describes how to import and export variables to and from SNF Files.

To import a variable:

1. Open the folder into which you wish to import an SNF file.
2. Choose Import Variable from the VDT CSM or the Tools menu. A browse dialog box appears asking you to locate the file that you wish to import.
3. Locate the file that you wish to import.
4. Click the Open button. The file is imported and the variables are displayed in the VDT.

Details on Importing an SNF File

- VersaPro ignores the Header section of SNF files.
- The Imported SNF file must contain a PT_ID field, and that field must be the first field in the first non-comment field row.
- The number of Data Entries must correspond to the number of Field Names.

VersaPro supports the following field names:

- PT_ID (name)
- ADDR
- DESC
- PT_TYPE
- LENGTH
- RETENTIVE
- OVERRIDE
- STORED_VAL
- SHOW_EXT

All other field names and corresponding data entries are ignored.

- Empty data entries default to the same default entry as the VDT.
- Any data entries that violate row validation , contain invalid entries for a particular field (other than the PT_TYPE field), or repeated variables produce a conflict error.
- All imported SNF variables are added to the global table unless another block has been specified in the address field.
- Imported SNF variables are added below any existing variables.
- Selecting Cancel from the Conflict dialog cancels the entire import process. All data is purged.
- Any Description that contains quotation marks must start and end with quotation marks, to determine where separations occur between Descriptions and the additional text in the variable.

To export a variable:

1. From the VDT, select the variable or variables that you wish to export.
2. Choose Export Variable from the VDT CSM or the Tools menu. If no variables are selected, an error message appears informing you that at least one variable must be selected in order to export. A dialog appears asking you to determine the location to which you wish to save the exported file.
3. Choose a location. The default export location is the last Import/Export directory used. Click OK.

Details on Exporting an SNF File

- The following Field Names are exported as:
 - PT_ID (name) - variable name
 - ADDR (“address, block name” format for local variables) - variable reference address and scope
 - DESC - variable description
 - PT_TYPE - variable type
 - LENGTH – length of variable
 - RETENTIVE - variable retentive state
 - OVERRIDE - variable override state
 - STORED_VAL - stored values in comma delimited format
 - SHOW_EXT – variables to be viewed by HMI
- The \$\$&&FileType section of the SNF header will be I/O.
 - VersaPro does not export the ##DelVarDEcl section of the SNF header.
 - Any additional comments in the SNF files must be added using an outside editor.
 - The default extension of the exported file is *.SNF.

Variable Resolution

This dialog allows you to easily resolve variable conflicts. You can keep existing variable definitions or overwrite them. This dialog appears as the result of a Paste, Import SNF, or Insert Block operation that causes one or more variables to conflict with existing variables.

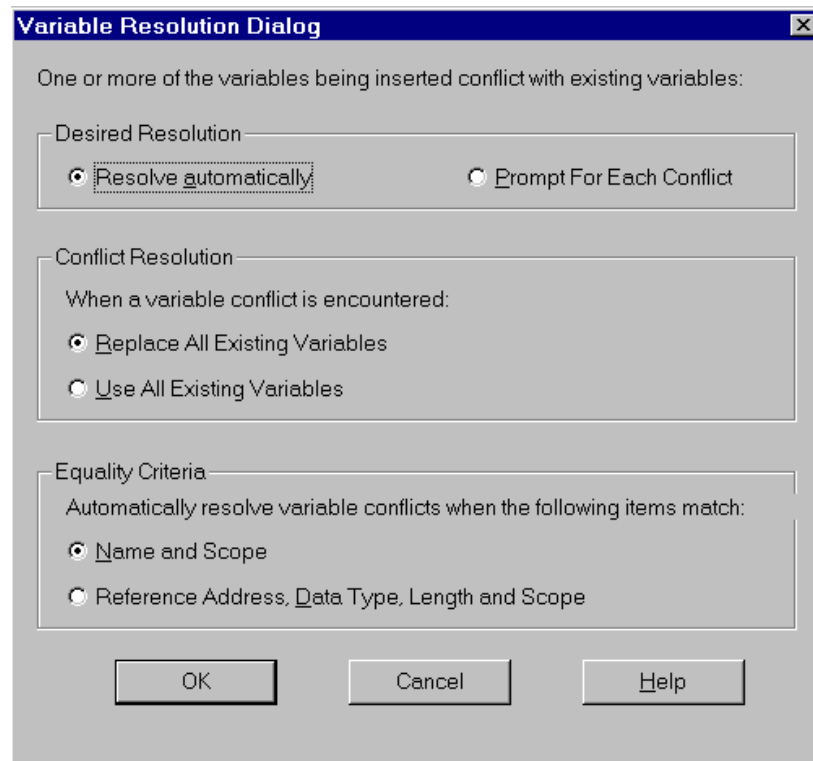

If Prompt for Each Conflict is selected, the following dialog box will appear.

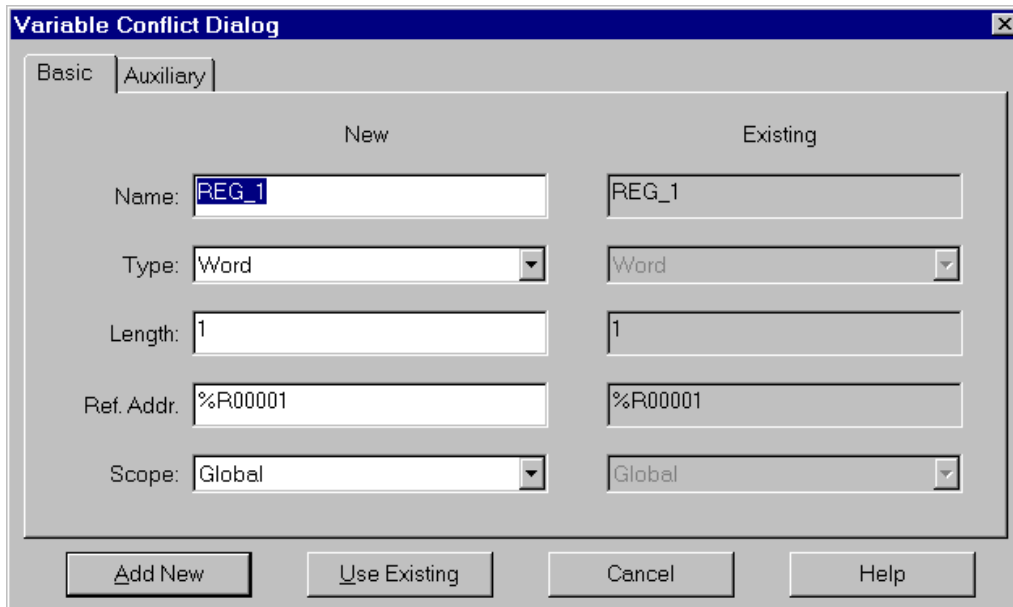

The image shows a 'Variable Conflict Dialog' window with a blue title bar and a close button. It has two tabs: 'Basic' and 'Auxiliary'. The 'Basic' tab is active. The dialog is divided into two columns: 'New' and 'Existing'. Each column has five input fields: 'Name', 'Type', 'Length', 'Ref. Addr.', and 'Scope'. The 'New' column has the following values: Name: REG_1, Type: Word, Length: 1, Ref. Addr.: %R00001, Scope: Global. The 'Existing' column has the following values: Name: REG_1, Type: Word, Length: 1, Ref. Addr.: %R00001, Scope: Global. At the bottom of the dialog are four buttons: 'Add New', 'Use Existing', 'Cancel', and 'Help'.

	New	Existing
Name:	REG_1	REG_1
Type:	Word	Word
Length:	1	1
Ref. Addr.:	%R00001	%R00001
Scope:	Global	Global

To enter Description, Stored Value, Scope, Override, Retentive, and External for the variable, select the Auxiliary tab. (These values can also be edited in the VDT.)

Chapter 7

Configuring PLC Hardware

Stand Alone Hardware Configuration (HWC) contains the configuration information for your Series 90-70, Series 90-30, VersaMax, VersaMax Nano/Micro, and Series 90 Micro PLCs, as well as Ethernet Global Data (EGD) configuration. It also provides tools to allow you to monitor power consumption and I/O mapping for modules added to your system. The default rack and CPU configuration that appears when you enter HWC is set by selecting Options from the Tools menu in VersaPro.

The configuration information must match the physical hardware of your system. Typical steps in configuring your PLC hardware include:

- Configuring the rack type and power supply
- Selecting and configuring a CPU for a PLC rack system, or an NIU for a VersaMax Remote I/O rack system.
- Configuring modules and customizing parameters for your application
- Configuring EGD exchanges and Name Resolution, if applicable
- Saving the HWC so that it can be stored to the PLC from VersaPro

Detailed information about configuring parameters for a specific module is available through the online help. To access this information, open the Parameter Editor window for the module (double-click the module), then select Module Help from the Help menu.

Chapter Contents

- Accessing Hardware Configuration
- Configuring the Series 90-30 Rack
- Configuring the Series 90-70 Rack
- Configuring the VersaMax Modular Rack
- Configuring the VersaMax Remote I/O Rack
- Configuring VersaMax Nano and Micro PLCs
- Configuring Series 90 Micro PLCs
- Hardware Configuration Reference View
- Hardware Configuration Log View
- Converting Rack Systems
- Printing Hardware Configuration

Accessing Hardware Configuration

To access HWC from VersaPro, double-click the Hardware Configuration icon  in the folder browser. The rack system for the configured CPU hardware will appear, along with a graph showing power consumption statistics for the module, a table showing references used in hardware configuration, and a log that maintains a record of HWC events.

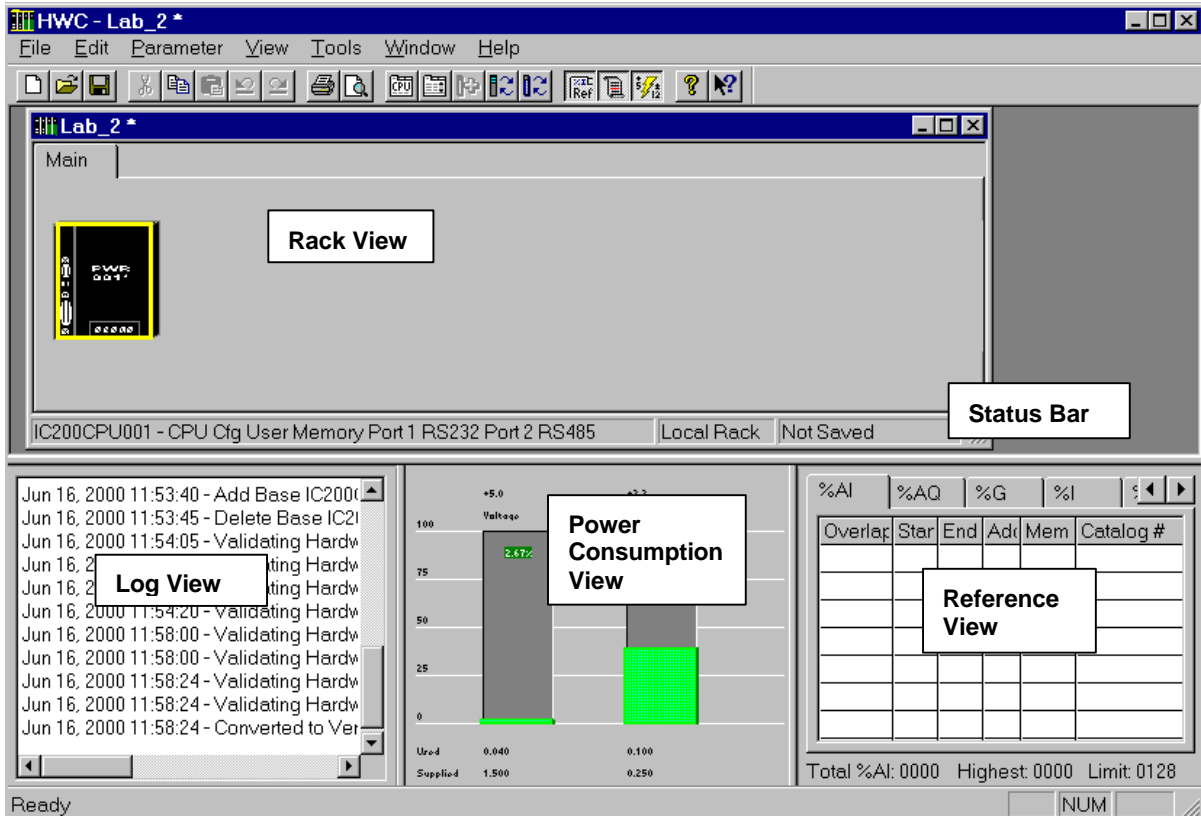

Hardware Configuration Toolbar

When you launch HWC, the main window displays While you are working in Hardware Configuration, you may want to display the Hardware Configuration toolbar, which provides access to commonly used areas of Hardware Configuration:

To display the Hardware Configuration toolbar, go to the View menu and place a checkmark next to Toolbar.

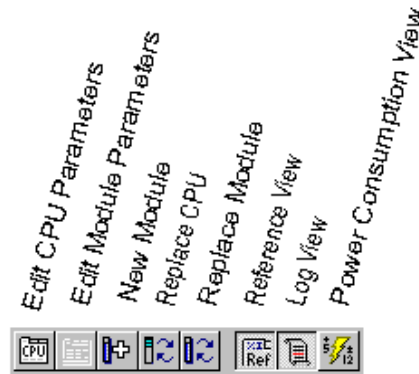

Using the Parameter Editor

To configure module parameters, you will use the Parameter Editor, which appears automatically when you insert or replace a module. To change parameters for a module, choose Configure Parameters from the context-sensitive menu, or choose Configure Parameters from the Edit, Module Operations submenu, or double click on the module.

The Parameter Editor provides an extended set of Windows-compatible editing facilities to make configuring your system less labor intensive.

- Parameters are displayed in an edit window that can be resized, maximized, and minimized.
- You can open multiple parameter views at the same time. This feature allows you to view the parameter set of one module while editing another, and you can easily copy and paste a single parameter value between module views.
- The Edit Window can be displayed in Tabbed mode (default) or Spreadsheet Mode (allows all parameter groups to be displayed and edited in a single, scrollable view). To change the display, select Parameter Edit from the View menu.
- The Title Bar of the window uniquely identifies the associated module with the rack system name, the module rack/slot address, and the module catalog number.

Note: Some of the more complex modules, such as the Motion modules, contain key parameters known as *Mode Setters*.

All parameters, including Mode Setters, that affect other parameters are listed in *italics*. To obtain an explanation of parameter relationships for these parameters, press **F1** in the Editor window and select the parameter name from the Help index. Or, right click the parameter and select What's This from the CSM.

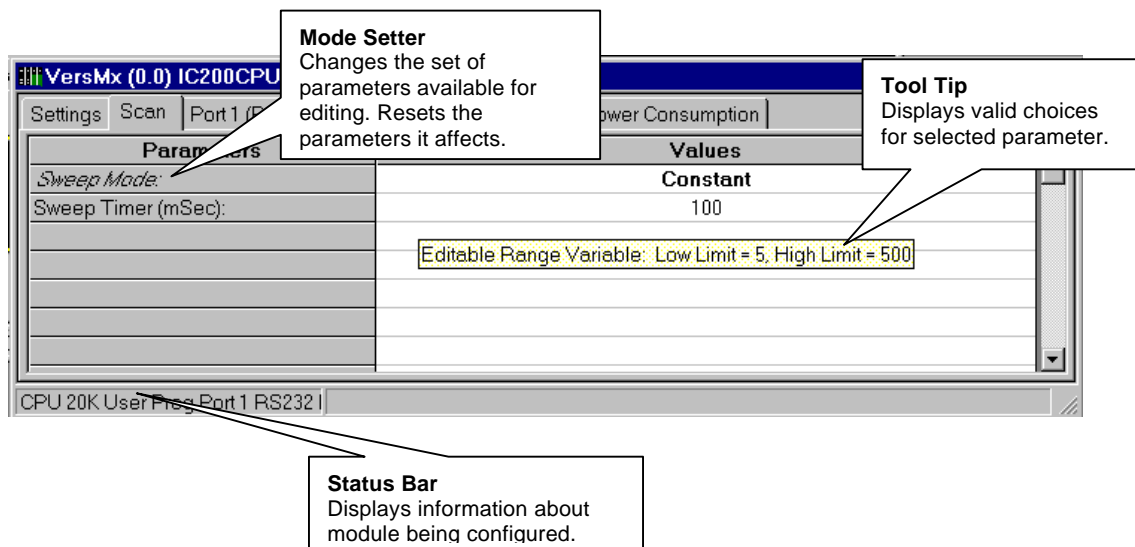

Editing Tips

Valid values for each parameter are displayed in a tool tip that appears when you hover the mouse cursor over the parameter cell. To edit parameter values:

- Type directly into the selected cell in a manner similar to typing into a spreadsheet cell, or use the Data Entry Tool. To open the Data Entry Tool, right click in the parameter cell and choose Data Entry Tool from the context-sensitive menu, press the F2 key, or double click.
- If the valid values consists of a list of choices with unique initial letters, select a value by simply typing its first letter in the cell.

You can save time when entering the same value for multiple parameters (of the same type) by **Copying and Pasting** or **dragging and dropping** one parameter value into other parameter value cells. Copy/Paste and drag/drop can be used within the same module view or between module views.

Drag/drop works with the keyboard as follows:

- To copy the data from the source cell to the drop cell, do not press any key, or press the **Ctrl** key while dragging.
- To move the data from the source cell to the drop cell, press the **Shift** key while dragging.
- To copy the data from the source cell to all cells between the source and drop cell (including the drop cell), press the **Alt** key while dragging. This assumes that drag and drop is occurring on the same Edit window and the source and drop cells are in the same column. This feature allows you to quickly fill an entire range of cells with identical information.

Note: Parameter values that have been changed since the start of the editing session are shown in **bold**.

Undoing Changes

- To reset a single parameter to the Start of Edit Session value or to Factory Original (default) setting, right click on the parameter and choose Reset Parameter from the context-sensitive menu.
- To reset all the parameters on a tab, right click anywhere in the tab, and choose Reset Tab from the context-sensitive menu.
- To Undo changes, choose Undo from the Edit menu, or click the Undo button on the Editor toolbar.

The Editor supports from 1 to 32 levels of Undo/Redo (default is 10). You can set the levels of Undo/Redo by choosing Options from the Tools menu.

Note: You cannot Undo changes that result from changing a Mode Setter parameter.

Error Notification

Erroneous values are displayed in the Error Color (red by default) and an explanatory ToolTip is provided for the error.

To see the ToolTip for an erroneous setting in the Parameter Editor, hover the mouse cursor over the parameter cell.

To change error notification colors

1. Select Options from the Tools menu.
2. In the Options dialog box, choose the General tab.

3. In the Colors list, choose the condition for which you want to set the color.
4. Click the Choose button. The Windows color selection dialog box will open.
5. Select a color, click OK in the color selection dialog box, then click OK in the Options dialog box.

Correcting Errors

To automatically correct an erroneous value, right click on the value and select Auto Correct from the context-sensitive menu. If you attempt to close a configuration that contains an error, the Parameter Error List dialog box will appear. To automatically correct all errors listed in this dialog box, click the Auto Correct button.

Shortcut Keys for HWC

You can edit information in Hardware Configuration through menu bar selections, the context-sensitive menu, or short-cut key sequences.

- To edit modules using the menu bar, click the module or slot you want to configure, go to the Edit menu, and select the appropriate action.
- To edit modules using the right mouse button, click the module or slot you want to configure, click the right mouse button, and select the appropriate action.
- To edit modules using standard cut, copy, and paste functions, highlight the module and use the Edit menu options or CTRL key shortcuts.
- To copy a module, click the module you want to copy and press CTRL+C. To paste the module, click the new slot and press CTRL + V.
- To cut a module (which allows you to paste it in another slot), click the module and press CTRL+X. To delete a module, click the module, and select Delete from the Edit Menu or press the Delete key.
- To Undo a previous operation, press CTRL + Z.
- You can use drag and drop to move modules between slots. To use drag and drop, highlight the module you want to move, click and hold the left-mouse button, and drag the module to the new slot.
- To close a window, press Ctrl + F4.
- To Close HWC, press Alt + F4.

Setting Options in Hardware Configuration

To set HWC options, go to the Tools menu and select Options. To adjust the size and content of the HWC System Log, enable Audit Trail Mode, set the number of Undo Levels, and select Error and Warning colors, select the General Options tab.

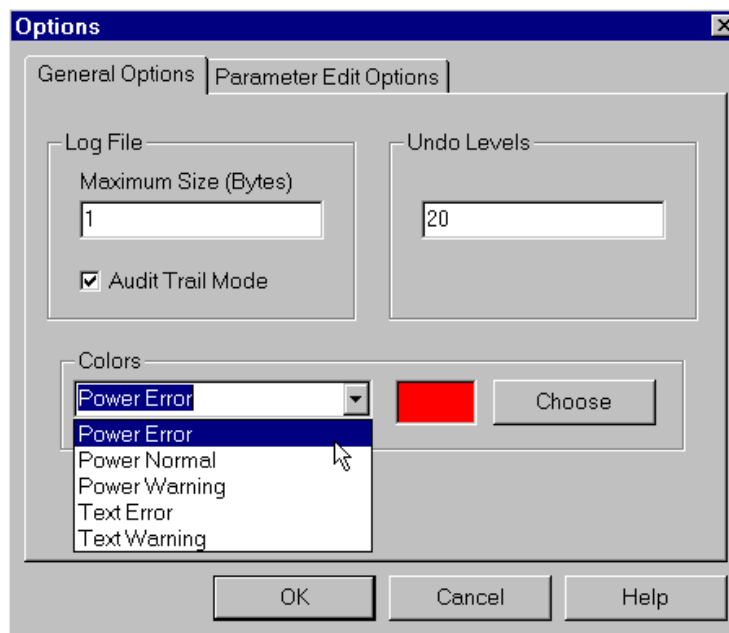

To change the format of the Parameter Editor window and the mode for assigning the next reference, select the Parameter Edit Options tab.

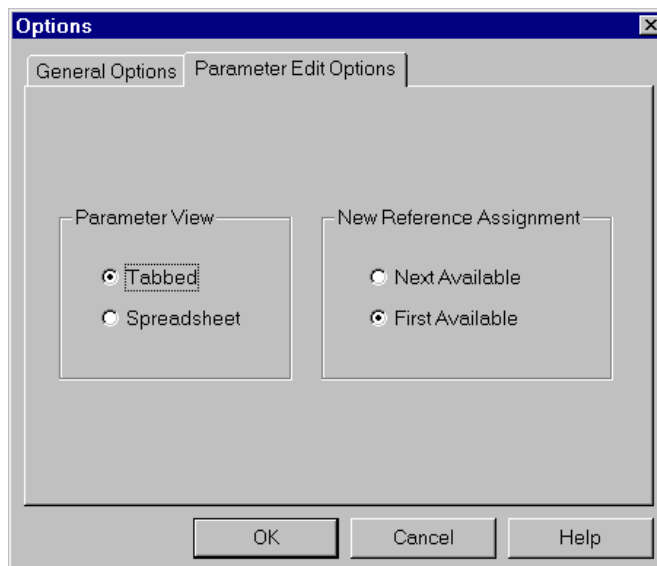

Configuring a Series 90-30 or 90-70 Rack

When you enter Hardware Configuration for the Series 90-30, the default view is the Rack (Main). The default 90-30 CPU model is the CPU351. The default 90-70 CPU model is the CPX772.

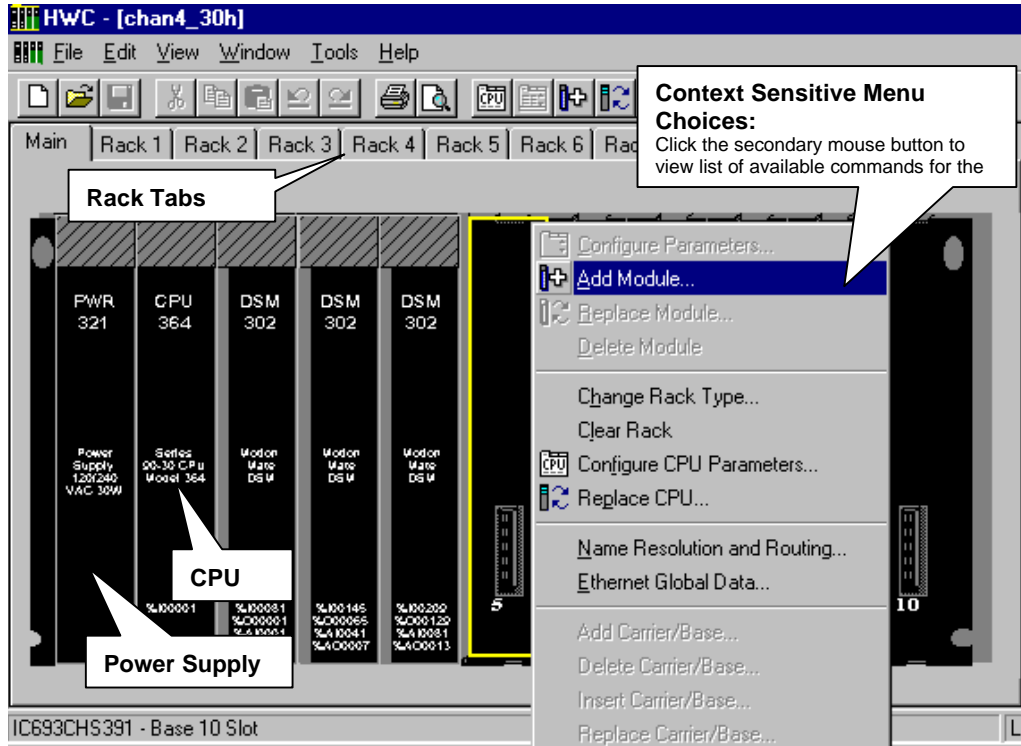

Changing Rack Type

To change rack type:

1. Position the cursor anywhere in the Rack window, then click the right mouse button.
2. Choose Change Rack Type.
3. Click the catalog number and description of the type matching your system, then click the OK button.

Note: Change Rack Type is only active for Series 90-70 and non-imbedded Series 90-30 CPUs (CPU331 and higher).

Changing/Configuring Power Supply and CPU

Configuring a Power Supply

To change the default power supply:

1. Click the power supply slot in the Rack window.
2. Click the right mouse button and choose Replace Module.
3. Click the catalog number and description of the power supply in your system, then click the OK button.
4. Respond to prompts if any appear.
5. When you replace the default power supply, the Parameter Editor appears allowing you to view detailed power consumption information. If you are using the default power supply, you can double-click on the power supply slot in the Rack window to view the details.
6. When you have finished, click the OK button.

Configuring a CPU

To change the default CPU:

1. From the rack view, click the right mouse button and choose Replace CPU.
2. Click the catalog number and description of the CPU in your system, then click the OK button.

Note: To configure EGD exchanges for a 90-30 CPU364 or a 90-70 CMM742, see "Ethernet Global Data Configuration" on page 7-33.

Configuring the CPU's Parameters

To configure the CPU's parameters:

1. When you replace the CPU, the Parameter Editor window appears. If you are using the default CPU, then double-click the CPU slot.
2. Within the Parameter Editor window, click the tab pertaining to the parameters you want to view or modify (where applicable).
3. Click in the Values fields you want to edit. (See "Editing Tips" on page 7-4.)
4. When you have finished editing the CPU parameters, click the window close button.



Adding/Configuring Rack Modules

To add modules to the rack:

1. Select the slot where the module is to be placed.
2. Double-click on the empty slot or click the right mouse button and choose Add Module. (If you are replacing a previously configured module, click the right mouse button and choose Replace Module.)
3. Click the tab describing the I/O module type you need (Discrete Input, Discrete Output, Analog Input, Analog Output, Communications, etc.).
4. Click the catalog number and description of the module in your system, then click the OK button.

Configuring the Module's Parameters

To configure the module's parameters:

1. When you add or replace a module, the Parameter Editor appears. You can also access this dialog box by double-clicking the module slot from the Rack window.
2. Within the Parameter Editor, click the tab pertaining to the parameters you want to view or modify (where applicable).
3. Click in the Values fields you want to edit. (See "Editing Tips" on page 7-4.)
4. When you have finished editing the module parameters, click the window close button. 

Configuring Expansion Racks

Expansion racks are configured in the same manner as the main rack. To add modules to an expansion rack, click the Rack tab and add the module configuration which corresponds to the attached hardware.

Deleting Rack Modules

Deleting a module removes it from the rack. If you save the Hardware Configuration after deleting the module, the configuration information about the deleted module will be lost. Perform these steps to delete a module:

1. Select the module you want to delete.
2. Press the Delete key or click the right mouse button and choose Delete Module.

Clearing the Rack

Clearing the rack removes all modules except the power supply and CPU. If you save the Hardware Configuration after clearing the rack, the configuration information about the deleted modules will be lost.

Perform these steps to clear the rack configuration:

1. Click anywhere in the Rack.
2. Click the right mouse button and choose Clear Rack.
3. A confirmation dialog box will appear. To confirm the clear rack operation, click the Yes button.

Genius Bus Configuration (Series 90-70 PLCs)

The Genius Bus view is used to configure the bus attached to a 90-70 Genius Bus Controller (GBC). This window contains serial bus addresses (SBAs) for 32 devices (0 – 31). The controlling GBC occupies the SBA corresponding to its Serial Bus Address (31 by default), which is configured in the module parameters for the GBC. In a Redundant Controller system, the redundant GBC also occupies a SBA on the bus.

SAHWC assigns a name to the bus in the format *FileName: Bus_rack_slot*. If you move the GBC to a different rack/slot location, the bus name will be updated.

The Genius Bus view appears automatically when you add a GBC to the 90-70 rack system configuration. You can also access this window by selecting a GBC and choosing Expand Bus from the context sensitive menu (CSM).

Bus Operations

To set Redundancy to Yes for all devices on the bus

Go to the Edit menu, select the Bus Operations submenu, and choose Set All Devices Redundant. On all blocks that have a Redundancy parameter, it will be set to Yes.

To set Redundancy to No for all devices on the bus

Go to the Edit menu, select the Bus Operations submenu, and choose Set All Devices Non-Redundant. On all blocks that have a Redundancy parameter, it will be set to No.

To clear the bus

Choose Clear Bus from the Edit, Bus Operations submenu or from the CSM. All blocks will be removed from the bus except for the controlling GBC.

Block Operations

Except for Edit Configuration, these operations cannot be performed on the controlling GBC in a Genius bus. In a Redundant Controller system, Edit Configuration, Copy, and Paste can be performed on the redundant GBC.

To add a block

Double click an empty SBA, or select the SBA, go to the Edit menu, and choose Block Operations, Add Block. The Block Catalog will appear. Select a device and click OK.

To edit block configuration

Select the block and choose Configure Parameters from the Edit, Block Operations submenu or from the CSM. The Parameter Editor window for the selected block will appear.

Keyboard shortcut: Ctrl +E

To delete a block

Select the block and choose Delete Block from the Edit, Block Operations submenu or from the CSM. (To delete all blocks, except the controlling GBC, from the bus, use the Clear Bus command.)

Keyboard shortcut: Del

To replace a block

Select the block and choose Replace Block from the Edit, Block Operations submenu or from the CSM. The Block Catalog will appear. Select a device and click OK.

Drag and Drop

You can use drag and drop to move a block to a different SBA on the Genius bus. (To move the controlling GBC, you must edit its Serial Bus Address in the Parameter Editor window.)

Cut, Copy, and Paste

To perform these commands, select a block and choose the command from the CSM.

Keyboard shortcuts:

<i>Cut</i>	<i>Ctrl + X</i>
<i>Copy</i>	<i>Ctrl + C</i>
<i>Paste</i>	<i>Ctrl + V</i>

CPU Redundancy

There are three types of basic CPU redundancy. These redundant systems can be used in combination with Genius redundancy schemes. For examples, see CPU Redundancy over Genius.

For more information about redundant systems based on IC697CGR772 and IC697CGR93, refer to the *Series 90-70 Enhanced Hot Standby CPU Redundancy User's Guide*, GFK-1527. For redundant systems based on IC697CPU780, refer to the *Series 90-70 Hot Standby CPU Redundancy User's Guide*, GFK-0827.

Single Bus with Preferred Master

Uses a single Genius bus with bus controllers in each PLC. The primary unit is always chosen as the active unit when the units initially synchronize. (GHS control strategy.)

Single Bus with Floating Master

Uses a single Genius bus with bus controllers in each PLC. No switchover occurs on initial synchronization to make the primary unit the active unit. (GDB control strategy.)

Dual Bus with Floating Master

Uses dual buses with the bus controllers in each PLC. No switchover occurs on initial synchronization. Bus Switching Modules (BSMs) are required in accordance with configuration of a dual bus network. This option provides redundancy of both the PLC and the I/O bus. (GDB control strategy.)

Configuring CPU Redundancy Over Genius

CPU Redundancy Over Genius Types

There are five types of CPU Redundancy Over Genius systems, which are built upon the various types of redundant Genius systems.

CPU Redundancy (GHS) Using Genius Dual GBC Redundancy (Paired GBC External) – Single Bus with Preferred Master

CPU Redundancy (GDB) Using Genius Dual GBC Redundancy (Paired GBC External) – Single Bus with Floating Master

CPU Redundancy (GDB) Using Genius Dual Bus Redundancy (Paired GBC External) – Single Bus with Floating Master

CPU Redundancy (GDB) Using Genius Dual Bus and Dual GBC Redundancy – Dual Bus with Floating Master

CPU Redundancy (GDB) Using a Mixed Genius Redundancy Scheme

CPU Redundancy (GHS) Using Genius Dual GBC Redundancy (Paired GBC External)

The following procedure configures two separate PLCs in one equipment folder. The first one configured will be considered the Primary PLC in the system. The software will automatically create the configuration for the Secondary PLC. The configuration of the two PLCs will be identical except for a few necessary differences such as CPU Redundancy Mode (Primary or Secondary) and the Serial Bus Addresses (SBA) of the GBCs (31 for the Primary and 30 for the secondary).

1. From the Redundancy menu, select Wizard.
2. In the Wizards window, select a CPU. CPU model CPU780, CGR772, or CGR935 can be used in this redundancy system.
3. Select the Single Bus with Preferred Master redundancy setup and click Next.
4. Select the Rack and Slot locations for the BTM and RCM. Click Next.
5. Review the settings for Redundancy Scheme, BTM location, and RCM location. If settings are correct, click Finish. If you need to make changes, click Back.
6. When you click Finish, the wizard will create a rack configuration with the selected CPU, a BTM, and an RCM.
7. Use the redundancy wizard to configure Redundant Controllers, Two PLCs.
8. Configure critical data and all redundant %AQ and %Q references in the Shared I/O section of the CPU Settings tab.
9. Use the redundancy wizard to generate the secondary rack system.

CPU Redundancy (GDB) using Genius Dual GBC Redundancy (Paired GBC External)

The following procedure configures two separate PLCs in one Equipment Folder. The first one configured will be considered the Primary PLC in the system. The software will automatically create the configuration for the Secondary PLC. The configurations of the two PLCs will be identical except for a few necessary differences such as CPU Redundancy Mode settings (Primary and Secondary), the Serial Bus Addresses (SBA's) of the Genius Bus Controllers (31 for the Primary and 30 for the Secondary), and the possible differences in non-redundant Genius Bus devices.

1. From the Redundancy menu, select Wizard.
2. In the Wizards window, select a CPU. CPU model CGR772 or CGR935 can be used in this redundancy system.

3. Select the Single Bus with Floating Master redundancy setup and click Next.
4. Select the Rack and Slot locations for the BTM and RCM. Click Next.
5. Review the settings for Redundancy Scheme, BTM location, and RCM location. If settings are correct, click Finish. If you need to make changes, click Back.
6. When you click Finish, the wizard will create a rack configuration with the selected CPU, a BTM, and an RCM.
7. Use the redundancy wizard to configure Redundant Controllers, Two PLCs.
8. Configure critical data and all redundant references in the Shared I/O section of the CPU Settings tab.
9. Use the redundancy wizard to generate the secondary rack system.

CPU Redundancy (GDB) using Genius Dual Bus Redundancy (Paired GBC External)

The following procedure configures two separate PLCs in one Equipment Folder. The first one configured will be considered the Primary PLC in the system. The software will automatically create the configuration for the Secondary PLC. The configurations of the two PLCs will be identical except for a few necessary differences such as CPU Redundancy Mode settings (Primary and Secondary), and the Serial Bus Addresses (SBA's) of the Genius Bus Controllers (31 for the Primary and 30 for the Secondary).

1. From the Redundancy menu, select Wizard.
2. In the Wizards window, select a CPU. CPU model CGR772 or CGR935 can be used in this redundancy system.
3. Select the Single Bus with Floating Master redundancy setup and click Next.
4. Select the Rack and Slot locations for the BTM and RCM. Click Next.
5. Review the settings for Redundancy Scheme, BTM location, and RCM location. If settings are correct, click Finish. If you need to make changes, click Back.
6. When you click Finish, the wizard will create a rack configuration with the selected CPU, a BTM, and an RCM.
7. Use the redundancy wizard to configure Dual Bus, Two PLCs.
8. Configure critical data and all redundant references in the Shared I/O section of the CPU Settings tab.
9. Use the redundancy wizard to generate the secondary rack system.

CPU Redundancy (GDB) using Genius Dual Bus and Dual GBC Redundancy

The following procedure configures two separate PLCs in one Equipment Folder. The first one configured will be considered the Primary PLC in the system. The

software will automatically create the configuration for the Secondary PLC. Each PLC will have two GBCs and they will control two Genius Buses. The configurations of the two PLCs will be identical except for a few necessary differences such as CPU Redundancy Mode settings (Primary and Secondary), and the Serial Bus Addresses (SBA's) of the Genius Bus Controllers (31 for the Primary and 30 for the Secondary).

1. From the Redundancy menu, select Wizard.
2. In the Wizards window, select a CPU. CPU model CGR772 or CGR935 can be used in this redundancy system.
3. Select the Single Bus with Floating Master redundancy setup and click Next.
4. Select the Rack and Slot locations for the BTM and RCM. Click Next.
5. Review the settings for Redundancy Scheme, BTM location, and RCM location. If settings are correct, click Finish. If you need to make changes, click Back.
6. When you click Finish, the wizard will create a rack configuration with the selected CPU, a BTM, and an RCM.
7. Use the redundancy wizard to configure Dual Bus and Redundant Controllers, Two PLCs.
8. Configure critical data and all redundant references in the Shared I/O section of the CPU Settings tab.
9. Use the redundancy wizard to generate the secondary rack system.

CPU Redundancy (GDB) using a Mixed Genius Redundancy Scheme

The following procedure configures two separate PLCs, each in its own Equipment Folder. The first one configured will be considered the Primary PLC in the system. The Primary PLC shares CPU Redundancy Over Genius using a Dual Bus (Paired GBC External) scheme with the Secondary PLC. However, the Primary PLC also has another redundant Genius system using a Dual GBC (Paired GBC Internal) scheme that doesn't take part in the CPU redundancy scheme.

Use of Rack 7 in this CPU Redundancy Scheme

In this system, each PLC's CPU addresses the other PLC's Main Rack as though it was its own Rack 7. Therefore, Rack 7 in each PLC system (both Primary and Secondary) will be reserved for this purpose and will not be available for use as a physical expansion rack.

Storing the Configurations to the PLCs

The configurations for both the Primary and Secondary PLCs are stored in one Equipment Folder. The Store procedure lets you select what portions of the equipment configuration to include in a Store operation. Details about the store procedure in general are found elsewhere in the online help.

Basic Store Procedure

This example describes how to store the correct configuration to the Primary PLC. If your programmer is already connected to and communicating with the Primary PLC, skip down to Step 4.

1. Connect your serial communications cable from your programmer (probably a personal computer) to the PLC's programming port.
2. In the PLC menu, choose Connect. The Connect dialog box will appear.
3. Select the Device name of your communications setup, then click the Connect button. The connection will be made, and a Connection successful box will display. Click the OK button.
4. Select Tools on the Menu Bar to display the Tools menu.
5. Select Transfer Utilities on the Tools menu.
6. Select Store. The Store to PLC dialog box will display.
7. Select only Hardware Configuration and Primary in the selection window. A selected item will have a check mark next to it. Clicking the item will toggle its selection check mark between on and off.
8. When finished with your selections, click the Store button to store your Primary configuration to the Primary PLC.

Note: You can use this basic procedure to store your Secondary configuration to the Secondary PLC, by connecting your programmer to the Secondary PLC and selecting Secondary instead of Primary in the selection window in step 7 above.

Configuring the Genius Redundant System

Genius Redundancy Types

There are five types of redundant Genius systems. These are sometimes used in conjunction with CPU redundancy schemes to provide additional protection against component failure. This type of system is called "CPU Redundancy Over Genius."

Dual Bus Redundancy (Paired GBC Internal)

1. From the Redundancy menu, select Wizard. Note that two open rack slots must be available in this PLC for the GBCs, although the Paired GBC may be in another rack.
2. In the Wizards window, select Add GBCs for Genius Redundancy and click the Next button.
3. Select Dual Bus, One PLC and click Next.

4. Select rack and slot locations for the primary GBC and the Paired GBC. Click Next.
5. Review the settings for Redundancy Scheme and GBC locations. If settings are correct, click Finish. If you need to make changes, click Back.

When you click Finish, the software will create the two Genius buses, and will add a two GBCs to the PLC. The parameter settings of this second GBC (except for the rack and slot numbers, and SBA) will be a copy of those of the first GBC. These two GBCs will, by default, be assigned Serial Bus Addresses (SBAs) 30 and 31. Each bus will contain an image of its GBC.

To configure devices on a Genius bus, see "Genius Bus Configuration."

To copy the device configurations from a redundant bus to its partner, select Wizard from the Redundancy menu. Choose Copy a Redundant Bus and click Next. Follow the Wizard instructions to complete the copy operation.

Dual Bus Redundancy Paired (GBC External) System

1. From the Redundancy menu, select Wizard.
2. In the Wizards window, select Add GBCs for Genius Redundancy and click the Next button.
3. Select Dual Bus, Two PLCs and click Next.
4. Select rack and slot locations for the primary GBC. Click Next.
5. Review the settings for Redundancy Scheme and GBC locations. If settings are correct, click Finish. If you need to make changes, click Back.

When you click Finish, the software will create the two Genius buses, and will add a GBC to the PLC. The GBC will, by default, be assigned Serial Bus Address (SBAs) 31. Each bus will contain an image of its GBC.

Genius Blocks used on this system may be redundant or non-redundant. To configure devices on a Genius bus, see "Genius Bus Configuration."

To copy the device configurations from a redundant bus to its partner, select Wizard from the Redundancy menu. Choose Copy a Redundant Bus and click Next. Follow the Wizard instructions to complete the copy operation.

Dual GBC Redundancy (Paired GBC Internal) System

1. From the Redundancy menu, select Wizard. Note that two open rack slots must be available in this PLC for the GBCs. The Paired GBC may be in any rack.
2. In the Wizards window, select Add GBCs for Genius Redundancy and click the Next button.
3. Select Redundant Controllers, One PLC and click Next.
4. Select rack and slot locations for the primary GBC and the Paired GBC. Click Next.

5. Review the settings for Redundancy Scheme and GBC locations. If settings are correct, click Finish. If you need to make changes, click Back.

When you click Finish, the software will add two GBCs to the PLC. The parameter settings of this second GBC (except for the rack and slot numbers, and SBA) will be a copy of those of the first GBC. These two GBCs will, by default, be assigned Serial Bus Addresses (SBAs) 30 and 31. These SBAs should not be changed.

Genius Blocks used on this system may be redundant or non-redundant. To configure devices on a Genius bus, see "Genius Bus Configuration."

Although there is only one Genius bus in this system, each GBC has its own Genius Bus window. If all devices on the bus are configured as redundant, the Genius Bus windows for these two GBCs will be identical. However, if there are non-redundant devices on the bus, they will only appear in the Genius Bus window of the GBC that they were configured in.

To configure the second PLC rack in this system, see "Configuring the Second PLC."

Dual GBC Redundancy (Paired GBC External) System

1. From the Redundancy menu, select Wizard. Note that two open rack slots must be available in this PLC for the GBCs. The Paired GBC may be in any rack.
2. In the Wizards window, select Add GBCs for Genius Redundancy and click the Next button.
3. Select Redundant Controllers, Two PLCs and click Next.
4. Select rack and slot location for the primary GBC. Click Next.
5. Review the settings for Redundancy Scheme and GBC locations. If settings are correct, click Finish. If you need to make changes, click Back.

When you click Finish, the software will add a second GBC to the PLC. The parameter settings of this second GBC (except for the rack and slot numbers, and SBA) will be a copy of those of the first GBC. These SBA for the primary GBC will, by default, be 31. The SBA of the other GBC will be 30. It is recommended that you leave the SBAs at their default settings.

Genius Blocks used on this system may be redundant or non-redundant. To configure devices on a Genius bus, see "Genius Bus Configuration."

Although there is only one Genius bus in this system, each GBC has its own Genius Bus window. If all devices on the bus are configured as redundant, the Genius Bus windows for these two GBCs will be identical. However, if there are non-redundant devices on the bus, they will only appear in the Genius Bus window of the GBC that they were configured in.

To configure the second PLC rack in this system, see Configuring the Second PLC.

Dual Bus and Dual GBC Redundancy System

1. From the Redundancy menu, select Wizard. Note that two open rack slots must be available in this PLC for the GBCs. The Paired GBC may be in any rack.
2. In the Wizards window, select Add GBCs for Genius Redundancy and click the Next button.
3. Select Dual Bus and Redundant Controllers, Two PLCs and click Next.
4. Select rack and slot location for the two GBCs. Click Next.
5. Review the settings for Redundancy Scheme and GBC locations. If settings are correct, click Finish. If you need to make changes, click Back.

When you click Finish, the software will create the two Genius buses, and will add a two GBCs to the PLC. The parameter settings of this second GBC (except for the rack and slot numbers, and SBA) will be a copy of those of the first GBC. These two GBCs will, by default, be assigned Serial Bus Addresses (SBAs) 30 and 31. Each bus will contain an image of both GBCs.

Genius Blocks used on this system may be redundant or non-redundant. To configure devices on a Genius bus, see "Genius Bus Configuration."

To configure the second PLC rack in this system, see Configuring the Second PLC.

Configuring the Second PLC

1. To configure the second PLC rack in this system, first save the rack system.
2. Go to the Redundancy menu and select Wizard.
3. In the Wizards window, select Generate Secondary Rack System from the Current Configuration and click Next.
4. If you wish to change the name or location of the secondary rack, edit the path field. (You can also change the path by clicking the Browse button.)
5. Click Finish. A secondary rack system that is a copy of the primary rack system will be generated.

Configuring a VersaMax Modular Rack

When you enter Hardware Configuration for VersaMax equipment folders, the default view is the Rack (Main). The power supply (PWR001) and CPU (CPU001) are in the default configuration.

The VersaMax rack system is built by selecting carriers into which I/O, communications and power supply modules are added.

The default VersaMax rack system has a main rack. Multiple power supplies are supported on the main rack, as required by the modules you need to add into your rack system.

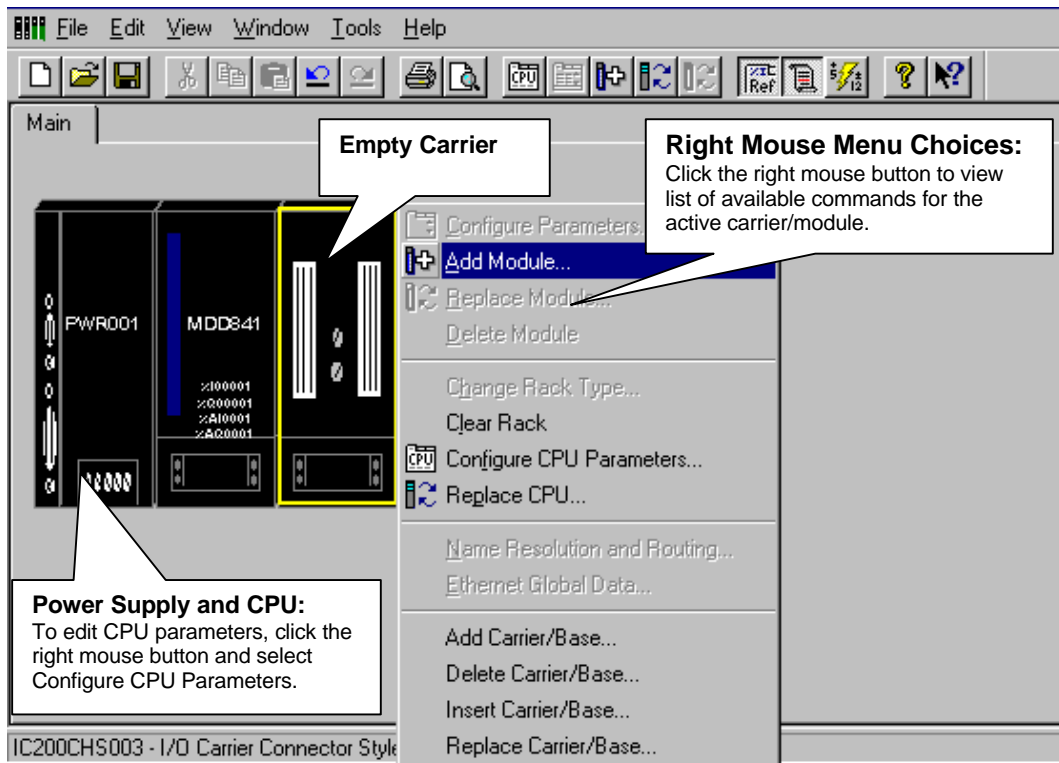

Two types of VersaMax expansion networks are available: Local Single Rack and Multiple Remote Rack. The Multiple Remote Rack configuration allows up to seven expansion racks. Multiple power supplies can be used in expansion racks.

In the physical hardware, field wiring is connected to the module carriers instead of the modules. HWC displays module wiring in the Module Parameters. If you move a module between carriers, be sure to update the wiring information accordingly.



Changing/Configuring the CPU

The default CPU is IC200CPU001.

- To replace the CPU:
 1. Click the secondary mouse button and choose Replace CPU from the CSM.
 2. Select a CPU from the Module Catalog. The Parameter Editor window for the selected CPU will appear.
 3. Review and modify CPU parameters in the Parameter Editor.
 4. When you are finished editing the CPU parameters, click the window close button  to close the Parameter Editor window.
- To view or change CPU parameters:
 1. Click the secondary mouse button and choose Configure CPU Parameters from the CSM. The Parameter Editor window for the CPU will appear.
 2. Review and modify CPU parameters in the Parameter Editor.
 3. When you are finished editing the CPU parameters, click the window close button  to close the Parameter Editor window.

Note: To configure EGD exchanges for a CPUE05 see “Ethernet Global Data Configuration” on page 7-33.

Rack/Module Operations

In addition to configuring the CPU (or NIU), the VersaMax rack configuration is completed through the following operations, as required:

- Changing/Configuring the Power Supply
- Adding Module Carriers
- Adding Power Supply Booster Bases
- Configuring a Power Supply for a Booster Base
- Adding/Configuring Modules
- Deleting Carriers
- Clearing the Rack
- Configuring VersaMax Expansion Networks

Changing/Configuring the Power Supply

The default power supply is the IC200PWR001. To change the default power supply:

1. Click the power supply slot, click the secondary mouse button and select Replace Module. Select the new power supply from the Module Catalog.
2. The Parameter Editor window for the power supply will appear.
3. When you are finished reviewing the power supply parameters, click the window close button  to close the Parameter Editor window.

Adding Module Carriers

Carriers must be configured to house module in the VersaMax PLC. Perform these steps to configure module carriers.

1. To add a carrier to the right of configured modules, click the right mouse button and choose Add Base/Carrier. The Module Catalog for Carriers will display.

To insert a carrier between two configured modules, highlight the module which will be to the right of the new carrier, click the right mouse button and choose Insert Base/Carrier. The Module Catalog for Carriers will display.

Note: You must click the right mouse button over a module or carrier in the rack configuration to view configuration choices from the right mouse button.

2. Click the catalog number and description of the carrier you want to add, then click the OK button.

Adding Power Supply Booster Bases

Power Supply boosters may be added into the system configuration to power modules downstream from the booster. Perform these steps to add a power supply booster base:

1. To add a Power Supply Booster Base to the right of configured modules, click the right mouse button and choose Add Base/Carrier. The Module Catalog will display.

To insert a Power Supply Booster base between two configured modules, highlight the module which will be to the right of the new base, click the right mouse button and choose Insert Base/Carrier. The Module Catalog will display.

2. Click the Power Supply Booster Bases tab. Click the catalog number to select the base, then click the OK button.
3. To configure the power supply, click the right mouse button and choose Add Module. Select the Power Supply from the list and click OK.

4. Configuring a Power Supply for a Booster Base

Power Supplies can be added throughout your VersaMax system. To add or replace a configured power supply on a Booster Base:

1. Double-click the empty booster base. For booster bases with configured power supplies, click the right mouse button and select Replace Module. The Power Supply Module Catalog dialog box will appear.
2. Click the catalog number of the power supply you want to configure, then click the OK button. The Parameter Editor will display.
3. You can view information about the power supply. Click OK to complete power supply configuration.

Adding/Configuring Modules

Once a carrier is configured, the module may be added to the system:

1. Highlight the carrier which will house the module.
2. Double-click on the empty carrier or click the right mouse button and choose Add Module. (If you are replacing a previously configured module, click the right mouse button and choose Replace Module.)
3. Click the tab describing the I/O module type you need (Discrete Input, Discrete Output, Analog Input, Analog Output, etc.).
4. Click the catalog number and description of the module in your system, then click the OK button.

Configuring Module Parameters

To configure the module's parameters:

1. When you add or replace a module, the Parameter Editor appears. You can also access this window by double-clicking the module slot from the Rack window.
2. Within the Parameter Editor, click the tab pertaining to the parameters you want to view or modify (where applicable).
3. Click in the Values fields you want to edit. (See "Editing Tips" on page 7-4.)
4. When you have finished configuring module parameters, click the window close button .

Deleting Rack Modules

Deleting a module removes it from the rack. If you save the Hardware Configuration after deleting the module, the configuration information about the deleted module will be lost.

Perform these steps to delete a module:

1. Select the module you want to delete.
2. Press the Delete key or click the right mouse button and choose Delete Module.

Deleting Carriers

You must use the menu bar or right mouse operations to delete a carrier. Perform these steps to delete a carrier:

1. Highlight the empty carrier you want to delete.
2. Click the right mouse button and choose Delete Carrier.

Clearing the Rack

Clearing the rack removes all modules (except the power supply and CPU). If you save the Hardware Configuration after clearing the rack, the configuration information about the deleted modules will be lost.

Perform these steps to clear the rack configuration:

1. Click anywhere in the Rack.
2. Click the right mouse button and choose Clear Rack.
3. A confirmation dialog box will appear. To confirm the clear rack operation, click the Yes button.

Configuring VersaMax Expansion Networks

There are three types of configurations in the VersaMax rack system. To change the rack configuration, select the type you want from the context-sensitive menu or from the Edit, Expansion Rack System submenu.

None

Includes only the Main VersaMax rack (no Expansion). Systems created using VersaPro 1.0 have this type of configuration. This is the default VersaMax System, which is created when you select New from the File menu or when you convert from another rack system, such as Series 90-30.

Local Single Rack

Includes the Main VersaMax I/O station and one Expansion rack. The Main VersaMax rack does not contain a Transmitter. The Expansion rack contains a non-isolated Power Supply and Receiver Integrated Unit (IC200ERM002). The power supply is not configured unless the Receiver unit is active. The default power supply in the expansion rack will be the same as the main rack's power supply. Replacing the main rack's primary power supply will not affect the expansion rack's primary power supply.

Multiple Remote Rack

Allows you to configure up to seven Expansion racks (seven Rack tabs are always shown). The Main VersaMax rack contains a Transmitter (IC200ETM001). The Non Isolated Receiver (IC200ERM002), which is configured by default, can be replaced by an Isolated Receiver (IC200ERM001).

Notes: The Transmitter and Receiver modules cannot be added from the module catalog. The only way to add these modules to a rack configuration is to choose the appropriate configuration type. Also, you cannot delete them from a rack configuration except by changing the rack configuration type.

If a single-ended receiver is configured and an expansion transmitter is present, a fatal “expansion transmitter mismatch” fault will be generated. This fault will also be generated if a differential (transmitter and receivers) is configured and no expansion transmitter is physically present. In these cases, no faults will be generated for individual modules in the expansion racks. The CPU detects the presence or absence of receiver modules connected through the expansion bus and compares the physical configuration with the programmed configuration. It will generate a “Loss of rack” alarm for missing receivers and an “Addition of or extra rack” alarm for extra receivers.

Switching Between VersaMax Rack Systems

You can switch from one VersaMax rack system type to another. This allows single rack systems created in VersaPro versions earlier than 1.10 to be upgraded to Local Single Rack and Multiple Remote Rack systems. Switching rack system types has the following effects:

When you switch configurations, a message is displayed which gives you the option of carrying out the parameter changes of the existing CPU/modules to the new rack configuration.

To change rack system type, choose Expansion Rack System from the CSM or the Edit menu. Select an expansion rack type from the submenu.

Changing VersaMax Rack Systems		
From	To	Results
None	Local Single Rack	A new expansion rack appears.
None	Multiple Remote Rack	Seven new expansion racks appear in the rack system.
Multiple Remote Rack or Local Single Rack	None	A message is displayed to warn about the loss of rack(s) and modules in it and the fact that these operations cannot be undone. If you click OK, the standard rack will be displayed.
Multiple Remote Rack	Local Single Rack	A message is displayed to warn about the loss of rack(s) and modules in it and the fact that these operations cannot be undone. If you click OK, a rack system containing Main and Rack 1 tabs will be displayed. If there is an isolated receiver in the first expansion rack, it is replaced with the default non isolated receiver.

Related Parameters for Multiple Remote Rack Systems

On the Settings tab for CPU parameters, the Expansion Bus Speed parameter appears if Multiple Remote Rack is selected and if there is an isolated receiver present in any one of the expansion racks. Values are Extended Distance (default) and Normal. For Normal distance, the maximum allowable cable length is 15m (250ft) and the baud rate may vary between 250KHz, 1MHz, 3MHz, or 5MHz. For Extended Distance, the maximum allowable distance is 250m (820ft) and baud rate is fixed at 250KHz.

Each expansion rack has one Power Supply and Non Isolated Receiver Unit. The isolated receiver can be replaced with the non-isolated receiver and vice versa. (see "Expansion Rack Operations").

Note: When a module is auto-configured and the Expansion Bus Speed setting changes as a result, an "Expansion bus speed change" fault will be generated. You should correct the Expansion Bus Speed setting.

Expansion Rack Operations

The catalog ID and description for the Power Supply And Receiver-Integrated unit is shown on the status bar. When you select the integrated unit, the receiver information is shown as a part of the status bar.

Selecting an Expansion Receiver

By default, the Expansion Receiver type is None. A power supply is not configured for the Expansion Rack until an Expansion Receiver is configured. There are three ways you can configure an Expansion Receiver:

- By adding any base unit in the expansion rack. A Non-Isolated Receiver Unit will be configured by default.
- By right-clicking on the rack and selecting a Receiver Unit from the Expansion Receiver submenu.
- By choosing a Receiver Unit from the Edit submenu, Expansion Receiver.
To deactivate the unit, select None from the Expansion Receiver submenu. (This option is not available if the rack configuration contains one or more Carrier/Base units.)

Changing Receiver Type for Expansion Racks in Multiple Rack Systems

The Power Supply And Receiver-Integrated unit consists of IC200PWR001 and IC200ERM002 (non-isolated receiver) by default. For expansion racks in Multiple Remote Rack systems, an isolated receiver (IC200ERM001) can be selected. To change the receiver, choose Expansion Receiver from the Edit menu or the CSM.

Viewing Power Consumption Values

To view the parameters for the power supply, double click on the Power Supply and Receiver-Integrated unit. Power values for the receiver are shown in the parameter dialog of the receiver and the value is non-editable. Receiver power is included as part of the total power consumption of the main power supply.

To view the parameters for the receiver, choose Configure Receiver Parameters from the context-sensitive menu or from the Edit, Rack Operations menu.

Clearing the Rack for Multiple Remote Rack Systems

When you select this option with focus on the Main rack, the transmitter will not be cleared. If you select this option with focus on expansion rack, it clears all the modules except the Power Supply And Receiver-Integrated unit.

Configuring Receiver Parameters

This option displays the Receiver parameters for the selected Expansion rack. (The Receiver units have no configurable parameters.)

Loading VersaMax Hardware Configurations

For general information on loading a hardware configuration, see “Loading a Folder to Your Computer” in Chapter 10.

VersaMax Modules with Shared IDs

When the configuration is loaded from a rack system, HWC uses the hardware module ID to determine the correct module catalog number and description. However, some VersaMax modules share the same module IDs. When a VersaMax rack system containing these modules is auto configured and the configuration is loaded an incorrect catalog number and description may be displayed. You will need to select the correct module from the modules catalog and store it to the rack system. After storing the configuration, you will be able to load the configuration properly.

The following modules share hardware module IDs:

- IC200MDL650 loads as IC200MDL636
- IC200MDL750 loads as IC200MDL742
- IC200MDL331 loads as IC200MDL329
- IC200MDD844 loads as IC200MDD842
- IC200MDL141 loads as IC200MDL140

Configuring a VersaMax Remote I/O Rack

A VersaMax Remote I/O (RIO) rack consists of a network interface unit (NIU) and supported I/O modules. Three types of NIUs are available: Genius (GNIU), Profibus (PNIU), and Ethernet (ENIU). All VersaMax I/O modules are supported except IC200BEM002 and IC200BEM103.

When you enter Hardware Configuration for VersaMax equipment folders, the default view is the Rack (Main). The power supply (PWR001) and CPU (CPU001) are in the default configuration. To configure a Remote I/O rack, you must replace the CPU with an NIU and configure the NIU parameters.

As in a VersaMax rack system with a CPU, the RIO rack system is built by selecting carriers into which I/O, communications and power supply modules are added.

The default VersaMax rack system has a main rack. Multiple power supplies are supported on the main rack, as required by the modules you need to add into your rack system.

The RIO supports two types of expansion networks: Local Single Rack and Multiple Remote Rack. The Multiple Remote Rack configuration allows up to seven expansion racks. Multiple power supplies can be used in expansion racks.

In the physical hardware, field wiring is connected to the module carriers instead of the modules. HWC displays module wiring in the Module Parameters. If you move a module between carriers, be sure to update the wiring information accordingly.

Configuring an NIU

The default CPU is IC200CPU001.

- To replace the CPU with an NIU:
 1. Click the secondary mouse button and choose Replace CPU from the CSM.
 2. Select an NIU from the Module Catalog. The Parameter Editor window for the selected NIU will appear.
 3. Review and modify NIU parameters in the Parameter Editor.
 4. When you are finished editing the NIU parameters, click the window close button  to close the Parameter Editor window.

- To view or change NIU parameters:
 1. Click the secondary mouse button and choose Configure NIU Parameters from the CSM. The Parameter Editor window for the NIU will appear.
 2. Review and modify NIU parameters in the Parameter Editor.
 3. When you are finished editing the NIU parameters, click the window close button  to close the Parameter Editor window.

Configuring the RIO Rack

The general procedures for configuring carriers, power supplies, and modules in an RIO rack are the same as for a modular CPU rack. For details, see “Rack/Module Operations” on page 7-22.

Load/Store/Verify RIO Configuration

For Genius and Profibus NIUs, the Load, Store, and Verify operations require cable IC200CBL002, which is used to connect a COM port on your PC to the serial port on the left side of the VersaMax NIU.

For Ethernet NIUs, these operations use an Ethernet connection.

Communications Setup

To define communications parameters for the rack system, select Communications Setup from the Tools menu. The CCU will open. (If a password has been defined for the Communication Configuration Utility, the Password dialog box will appear. Enter your password and press OK to continue.) The main screen of the Communication Configuration Utility will appear.

When configuring a Device in the CCU for use with a GNIU or PNIU, you should assign a Name and default Port. Port Type should be set to SNP_SERIAL. All other fields should be left at their default values.

When configuring a Device for use with an ENIU, you should assign a Name, default Port, and IP address. Port Type should be set to TCP/IP_ETH.

Storing RIO Configuration

To transfer the configuration data to the associated Rack System:

1. Choose Load/Store/Verify in the Tools menu.

If the configuration has not been saved, the message, “Please save this rack system first,” will appear, followed by the “Save As” dialog box. You must save the rack system once before the Load/Store/Verify dialog box can be opened. After you have saved the rack system once, auto-saves will be performed when this command is invoked.

2. In the Load/Store/Verify Hardware Configuration dialog box select a Device and a Port.

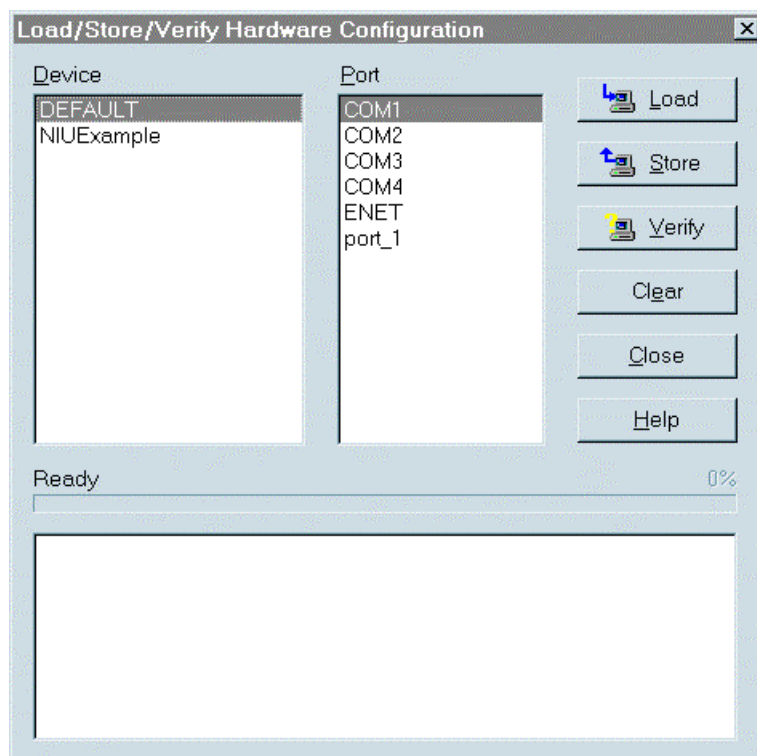

3. Click the Store button. The programming software will automatically connect to the NIU.

Note: If you attempt to store a hardware configuration to an NIU that does not match the type selected in the configuration, an error message will appear and the operation will be stopped.

Loading RIO Configuration

To load configuration data from the Rack System:

1. Choose Load/Store/Verify in the Tools menu.
2. In the Load/Store/Verify Hardware Configuration dialog box select a Device and a Port.
3. Click the Load button. The programming software will automatically connect to the NIU.

Note: If you attempt to load a hardware configuration from an NIU that does not match the type selected in the configuration, an error message will appear and the operation will be stopped.

VersaMax Modules with Shared IDs

When the configuration is loaded from a rack system, HWC uses the hardware module ID to determine the correct module catalog number and description. However, some VersaMax modules share the same module IDs. When a VersaMax rack system containing these modules is auto configured and the configuration is loaded an incorrect catalog number and description may be displayed. You will need to select the correct module from the modules catalog and store it to the rack system. After storing the configuration, you will be able to load the configuration properly.

The following modules share hardware module IDs:

IC200MDL650 loads as IC200MDL636
IC200MDL750 loads as IC200MDL742
IC200MDL331 loads as IC200MDL329
IC200MDD844 loads as IC200MDD842
IC200MDL141 loads as IC200MDL140

Verifying RIO Configuration

To verify the rack configuration:

1. In the Load/Store/Verify Hardware Configuration dialog box select a Device and a Port.
2. Click the Verify button. The programming software will automatically connect to the NIU, perform the verification, and disconnect from the NIU. The Log window will display the results of the operation.

Clearing RIO Configuration

This procedure clears the configuration and forces an autoconfiguration. If you clear the NIU and then do a load from the NIU, you will be loading a default configuration that will overwrite your existing configuration.

1. In the Load/Store/Verify Hardware Configuration dialog box select a Device and a Port.
2. Click the Clear button. The programming software will automatically connect to the NIU, clear the configuration, disconnect and display the results in the Log Window..

Ethernet Global Data Configuration

EGD allows one device (the producer) to transfer (exchange) data to one or more other devices (the consumers) at a regularly scheduled transfer rate. EGD exchanges can be configured for a Series 90-30 CPU364 or a VersaMax CPUE05.

Caution

EGD exchanges are designed for simple, efficient communication of sampled data between devices. They are not intended for event notification where the possible loss of a sample of data would be significant. For event notification, it is recommended that a Service Request Transfer Protocol (SRTP) connected service be used.

The exchange of data is uniquely defined through a combination of the Producer ID (identification number) and the Exchange ID:

- Each device exchanging Ethernet Global data on the network must be assigned its own unique Producer ID. This Producer ID uniquely identifies the source device of Ethernet Global data on the network. The Producer ID number is in dotted-decimal format (like an IP Address). For example, 3.0.0.1 is a valid Producer ID.
- An Exchange ID is a unique number that identifies a particular variable or group of variables to be transferred.

Producing devices and consuming devices operate completely asynchronously to each other. Therefore, for each device, both the data that the device produces and the data that the device consumes must be separately defined.

Note: For the CPUE05, the local Ethernet device used for each exchange is specified as a Rack/Slot value instead of as a configured Adapter Name. The CPUE05 does not support named aliasing and name resolution and routing. To define EGD exchanges for a CPUE05, refer to page 7-38.

Configuring the Ethernet Interface Adapter Name (CPU364)

If the CPU364 will be used in EGD exchanges, you must specify an Adapter Name. When you define an EGD exchange, you will use the Adapter Name to specify which network adapter will produce the exchange.

To specify the adapter name for a CPU364 Ethernet Interface:

- From Hardware Configuration, confirm that the CPU364 has been configured. Also, confirm that the IP address for the Ethernet module is correct. If so, double-click the CPU slot.
- The Parameter Editor will appear. Choose the Ethernet tab.
- Click the Values field beside Adapter Name and type a name for the adapter. When finished, click the OK button.

Setting Aliases for Remote Ethernet Interfaces (CPU364)

If a remote Ethernet controller will be used in EGD exchanges, you must associate an alias with the card's IP address. When you define an EGD exchange, you will use this alias to specify which network adapter will produce the exchange.

To specify an alias for a remote Ethernet Interface:

- In Hardware Configuration go to the Edit menu, choose Rack Operations, and select Name Resolution and Routing (or click the right mouse button and choose Name Resolution Routing from the pop-up menu).
- In the Name Resolution and Routing Table dialog box, click the Aliases tab.
- Click the Add Entry button.
- In the Alias field, type the name you want to use to refer to the remote Ethernet controller.
- Click the IP Address field and type the IP address of the Ethernet controller then click the OK button.

Name Resolution and Routing Table Configuration (CPU364)

The CPU364 supports the Routing Table feature, an advanced tool for configuring communications between PLCs. The Routing Table should not be configured without assistance from a network administrator. A Routing Table should only be configured when more than one gateway is to be configured.

Definitions of routing table terms:

Destination Subnet ID - The destination subnet of the data to be routed is evaluated against this subnet ID. A match (same subnets) causes the data to be routed to the next hop IP address.

Destination Subnet Mask - The mask associated with the destination subnet under evaluation.

Next Hop IP Address - The IP address where the data should be sent next to progress toward its final destination.

Cost - This field is reserved. Default value is 1.

Accessing the Routing Table Configuration

From Hardware Configuration go to the Edit menu, choose Rack Operations, and select Name Resolution and Routing. (or click the right mouse button and choose Name Resolution and Routing from the shortcut menu). The Name Resolution and Routing Tables dialog box will display.

In the Name Resolution and Routing Tables dialog box, click the Routing tab.

Click the Add Entry button.

In the Destination Subnet ID field, enter the subnet ID (in dotted decimal format) of the remote subnet to which you wish to route data (for example, 4.12.20.0).

In the Destination Subnet Mask field, enter the subnet mask associated with that remote subnet (for example, 255.255.255.0).

In the Next Hop IP Address field, enter the IP address of the local gateway to which you wish to send the data (for example, 3.16.32.1), then click the OK button.

Subnet, Subnet ID, Subnet Mask

The subnet mask is a mechanism to logically divide a large network into smaller subnets according to your local assignment of IP addresses to nodes on the network. Nodes on the network which have their IP addresses alike for the bits specified in the subnet mask can talk to each other *directly*; nodes whose IP addresses are not alike in these same bits must talk *indirectly*, via an intermediate gateway or router.

As described in an appendix to your Ethernet module user manual, the 32 bits of an IP address are divided between a *net id* part and a *host id* part. (The *class* of the IP address determines how many bits are in the *net id* and how many are in the *host id*.) In general, the *net id* portion of the IP address (on the left) is assigned by the Internet authorities. The *host id* (on the right) is assigned by your local network administrator. *Subnetting* is locally optional and consists of designating some (any number) of the *host id* bits as an extended *net id*, or *subnet id*. The added *subnet id* bits are normally taken from the *host id*

bits adjacent to the *net id* and the *subnet mask* identifies these bits. In your Ethernet module configuration, you specify these bits as one (1) and the remaining *host id* bits as zero (0). For example:

IP Address:	11.22.33.44		
<i>Net Id</i> bits:	255.0.0.0	<i>Net Id:</i>	11.0.0.0
Added <i>Subnet Id</i> bits:	0.255.0.0	<i>Subnet Id:</i>	0.22.0.0
<i>Subnet Mask:</i>	255.255.0.0	"Extended" <i>Net Id:</i>	11.22.0.0

Subnet ids and subnet masks are entered into the Routing Table when configuring Multiple Gateways. The *extended net id* (for example, 11.22.0.0 in the above example) should be entered for the subnet id.

All nodes on a "subnetted" network must use the same value for subnet mask; subnets are distinguished by different *subnet id*'s, created by your local assignment of IP addresses.

Defining EGD Exchanges

You need to specify the operating characteristics and data to be exchanged for each exchange your PLC will produce or consume. Note the following exchange limitations:

- The maximum number of exchanges that can be defined for a PLC system is as follows:

Series 90 CPU364	128
VersaMax CPUE05	64

This number can be divided up into any combination of produced and consumed exchanges.

- Up to 100 variables can be configured per exchange. The CPUE05 is restricted to a total of 1200 variables across all EGD exchanges.
- The total size of a single exchange cannot exceed 1400 bytes. The total size is defined to be the sum of the data type lengths of all of the variables within the list. The exchange size is displayed in the Ethernet Global Data dialog box.

To define an EGD exchange:

1. From Hardware Configuration, go to the Edit menu, choose Rack Operations, and select Ethernet Global Data (or click the right mouse button and choose Ethernet Global Data from the pop-up menu).
2. In the Ethernet Global Data dialog box, click the Produced Exchanges tab to define exchanges produced by your PLC or click the Consumed Exchanges tab to define exchanges consumed by your PLC.

PLC Timing Considerations

Since the PLC scan time and the exchange time settings (Exchange Period for produced exchanges and Scan Period for consumed exchanges) are asynchronous, the following should be noted:

- The production of a data sample onto the network occurs at the specified Exchange Period and is independent of the time the data sample is actually updated from the CPU. The CPU will attempt to update the data sample at the Exchange Period interval but cannot guarantee delivery at that specific time due to being delayed by the PLC sweep time. For example, if the CPU is executing logic when the exchange period expires, the update will be delayed until the logic execution is complete. Therefore, the data sample produced on the network may be a duplicate of a previously sent sample. Use the timestamp feature to verify whether the data is new. (The CPU364 uses SNTP timestamping and the CPUE05 uses NTP timestamping.)
- The first update of the data sample from the CPU to the network adapter will occur at the end of the first scan. The first production of data onto the network will occur one Production Period after the CPU transitions to the I/O Enabled state.
- The CPU in the consumer will scan the data at the Scan Period independent of when the data is updated from the network. (The network adapter updates the data upon arrival of the data sample from the network.) Data will not be updated in CPU memory unless it has been received from the network.
- A range of reference memory within an exchange list can be viewed as coherent to scan if the length is less than 256 bytes. If interrupts are enabled, a string of multiple ranges may not all be deposited on the consumer side during the same scan.

Ethernet Global Data: Example 1

Here is an example to illustrate how EGD works. The figure that follows shows three devices (two PLCs and a PC running CIMPLICITY HMI) participating in an EGD exchange.

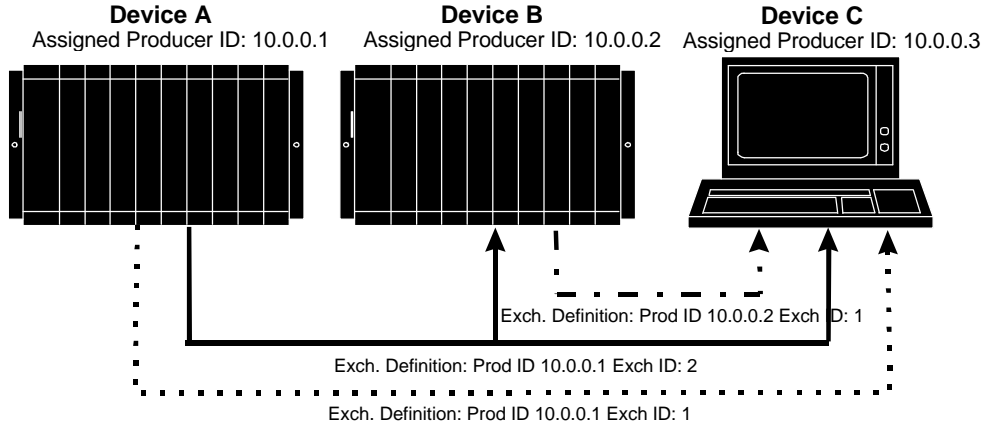

In this example, Device A produces two exchanges and consumes none, Device B produces one exchange and consumes one, and Device C produces no exchanges but consumes three. The exchange produced by Device A and consumed by both Device B and Device C is an example of Group Usage, whereby multiple devices consume data produced by one producing device.

Ethernet Global Data: Example 2

This example shows the details of a simple exchange of data from producing device A to consuming device B.

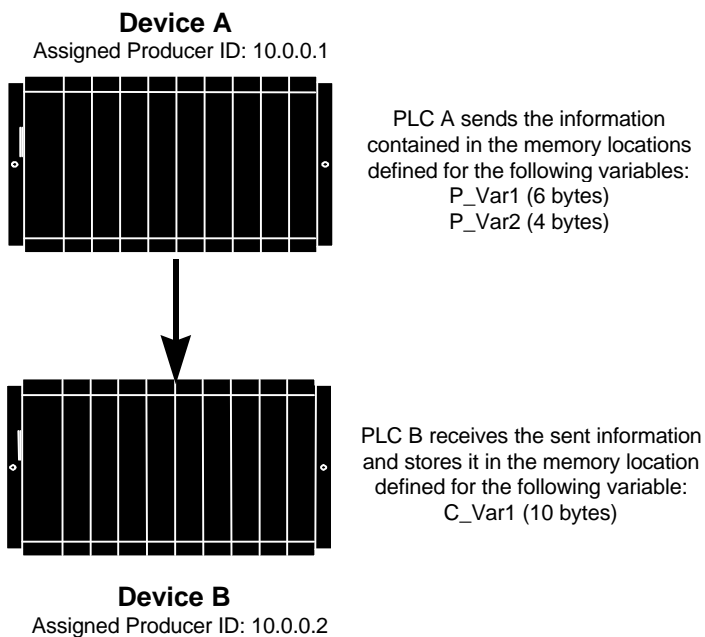

PLC A sends the information contained in the following reference memory locations. Each byte in the exchange contains eight discretes aligned at byte boundaries.

%I00001 to %I00016

%Q00001 to %Q00008

PLC B receives the information and stores it in three consecutive bytes in %G memory, as follows:

%G00001 to %G00024

Details of Producing PLC A

The details of the exchange that PLC A produces are defined in the Produced Exchanges tab of the Ethernet Global Data dialog box:

- **Local Producer:** By default, uses the IP address of the network interface card closest to the CPU of PLC A. The Local Producer can be changed by the user.
- **Exchange ID:** Identifies the packet of data that will be sent.
- **Net Address Name:** The name assigned to the network adapter within this PLC system that will be producing the exchange.
- **Consumer Type:** Specifies how the consuming device will be identified (by name, IP address, or group ID). For this example, the consuming PLC is identified by its Local Producer IP Address.
- **Consumer Address:** The Local Producer IP Address assigned to PLC B.
- **Send Type:** Defines when the exchange will be transmitted. This field is fixed at Always.
- **Producer Period:** PLC A will produce the data every 50 milliseconds.
- **Reply Rate:** Not used.
- **Status Word:** A reference address for status memory location where the status word is stored. The status word can signify when an error has occurred.

Details of Consuming PLC B

The details of the exchange that PLC B consumes are defined in the Consumed Exchanges tab of the Ethernet Global Data dialog box:

- **Local Producer:** Uses the IP address of the network interface card closest to the CPU of PLC B
- **Exchange ID:** Identifies the packet of data that will be received.
- **Net Address Name:** The name assigned to the network adapter within this PLC system that will be consuming the exchange.
- **Producer ID:** The Local Producer IP Address assigned to PLC A.
- **Group ID:** Used when more than one device is consuming the same exchanges from one producer. Value 0 means only one device is consuming the information.
- **Consumed Period:** The CPU of PLC B will scan the local network adapter for new data and/or status updates every 25 milliseconds.
- **Update Timeout:** The network adapter will set a status error to signal a refresh error if data is not received within 1000 milliseconds.

- **Status Word:** A reference address for the memory location where the status word is stored. The status word can signify when an error has occurred.
- **Time Stamp:** A reference address for the memory location where the time stamp is stored. The time stamp can be checked to verify if the data received is a new sample rather than a duplicate of a previously received sample.

Restoring EGD and Name Resolution

You cannot load EGD or Name Resolution from the CPU364. When you initiate the Load configuration process, the confirmation dialog box presents the option of backing up the EGD and Name Resolution configuration.

To restore these configuration components to your folder, go to the HWC File menu and select Restore EGD and Name Resolution. A browser window will open to enable you to navigate to the backup file.

Advanced User Parameters for EGD (CPUE05)

The Ethernet firmware maintains default values for all advanced user parameters. These default values satisfy the needs of most applications. Under special circumstances, some users may need to modify some of these parameters. Advanced user parameters can be modified using an Advanced User Parameters file, which can be created using an ASCII text editor. This file contains the name and value of all non-default advanced user parameters. (The Ethernet firmware assigns the proper default value to every advanced user parameter not specified in the Advanced User Parameters File.

All advanced user parameter data for a single Ethernet interface must be provided in a single file.

The Advanced User Parameter file is named AUP_0_0.apf, where 0_0 specifies the rack and slot location of the embedded Ethernet interface within the CPUE05. This file is placed in the folder containing the PLC configuration. During a Configuration Store operation, the VersaPro programmer stores the Advanced User Parameter file into the PLC along with the PLC Configuration.

Advanced User Parameter File Format

```
AUP_r_s  
<parameter name> = <parameter value>  
<parameter name> = <parameter value>  
<parameter name> = <parameter value>
```

- One parameter may be specified per line.
- Each parameter is listed by name and value, separated by an equals sign (=).
- All parameter names must be entered in lower case.
- Parameter values are converted to lowercase unless enclosed in a pair of double quotes (" "). The enclosing quotes are removed and the parameter value is not converted to lowercase.
- The parameter value data format depends upon the parameter. Numeric parameters are entered in decimal or hexadecimal format. Hexadecimal values must be terminated with an "h" or "H" character.
- IP address parameters must be entered in standard dotted decimal format. (Example: 10.0.0.1)
- The semicolon character delimits comments. All characters in the line following a semicolon are ignored.
- Blank lines are ignored.

Sample Advanced User Parameter File

```
AUP_0_0  
stpasswd = "system"  
g01_udp = 4741H  
g01_addr = 224.0.7.121  
g02_udp = 4742H  
g01_addr = 224.0.7.122  
; This is a comment
```

The CPUE05 advanced user parameters are similar to CPU364 advanced user parameters. Additional information for the CPU364 is provided in the *TCP/IP Ethernet Communications for the Series 90 PLC*, GFK-1541. For the CPUE05, refer to the *VersaMax Station Manager Manual*, GFK-1873.

Configuring VersaMax Nano and Micro PLCs

A VersaMax Micro PLC system consists of a main module and up to four optional Expansion Units. (The VersaMax Nano PLC does not support Expansion Units.)

The main module contains CPU, I/O, and HSC/PWM/PTO functions. Expansion Units provide I/O functions only. The compact, lightweight units are designed for 35mm DIN rail or panel mounting.

The sample system shown below has a main module (required) and one Expansion Unit.

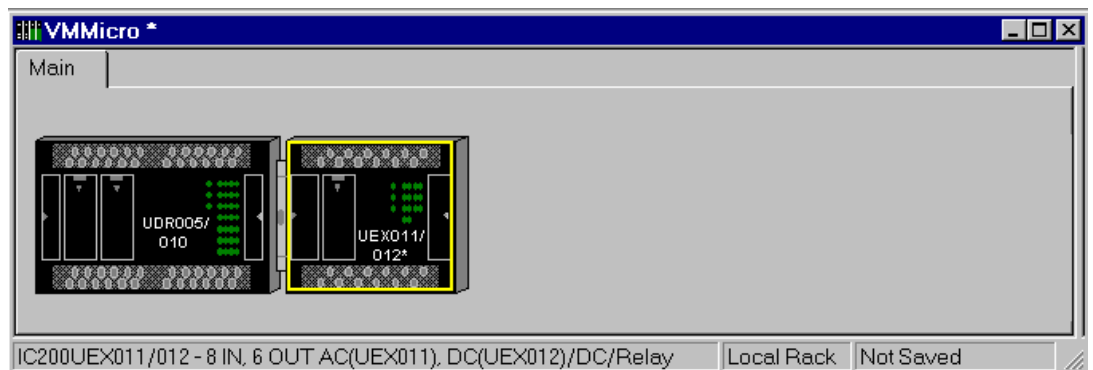

Rack/Module Operations

To replace a main module (IC200UDR005/010 is the default), select Replace Module or Replace CPU from the context-sensitive menu or select Replace CPU from the Edit, Rack Operations submenu.

To add an Expansion Unit to the system, select Add Module from the context-sensitive menu or from the Edit, Module Operations submenu. The Expansion Unit is added to the end of the chain.

To replace an Expansion Unit, select the Expansion Unit and choose Replace Module from the context-sensitive menu or from the Edit, Module Operations submenu.

To remove an Expansion Unit from the system, select Delete Module from the context-sensitive menu or from the Edit, Module Operations submenu. Only the last expansion unit in the chain can be deleted.

Note: The main module cannot be deleted from the system.

To remove all Expansion Units from the system, select Clear Rack from the context-sensitive menu or from the Edit, Rack Operations submenu.

When you add or replace a module, the Parameter Editor window will appear.

Counter, Pulse Width Modulation, and Pulse Train Output

To configure the High Speed Counter, Pulse Width Modulation, and/or Pulse Train Output functions, go to the Edit menu and select Module Operations, Configure Parameters, HSC/PWM/PTO. You can also choose Configure Parameters, HSC/PWM/PTO from the context-sensitive menu. A Parameter Editor window similar to the one shown below will appear (Nano PLCs have only three counter tabs.) For details on configuring these functions, choose Module Help from the Help menu.

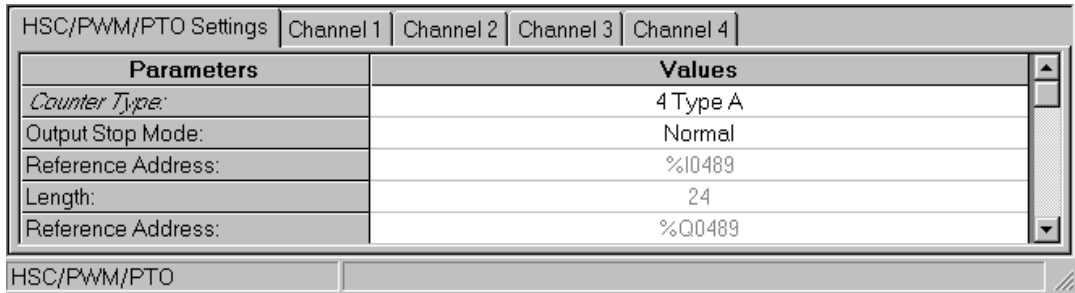

PWM Frequency and Duty Cycle

The frequency and duty cycle of the PWM output are specified from the application program. Pulse Train Output frequency is also controlled from the application program (duty cycle is nominally 50%).

For details on configuring and using these features, refer to Chapter 10 of the *VersaMax Micro PLCs and Nano PLCs User's Manual*, GFK-1645.

Configuring Averaging Filter for Analog Input Potentiometers

VersaMax Micro PLCs have two potentiometers, located below the Run/Stop switch, that can be used to manually set input values that are stored in %AI16 and %AI17.

The number of samples to be averaged can be controlled by the application program. By default, 16 samples will be averaged.

For details on configuring and using this feature, refer to Chapter 9 of the *VersaMax Micro PLCs and Nano PLCs User's Manual*, GFK-1645.

Configuring Series 90 Micro PLCs

A Series 90 Micro PLC is a self-contained module that provides CPU, I/O, and HSC/PWM/PTO functions. The 23 and 28-point Micro PLCs support up to four optional Expansion Units that provide I/O functions only. The compact, lightweight units are designed for 35mm DIN rail or panel mounting.

The sample system shown below has a main module (required) and one Expansion Unit.

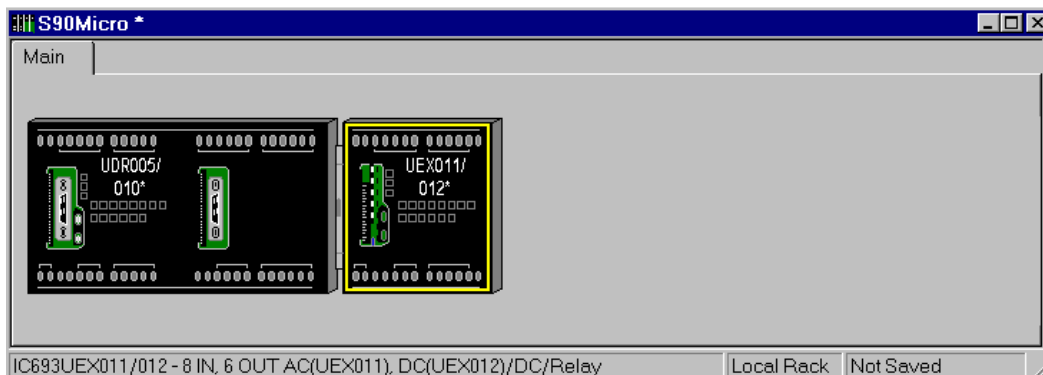

Rack/Module Operations

To replace a main module (IC693UDR005/010 is the default), select Replace Module or Replace CPU from the context-sensitive menu or select Replace CPU from the Edit, Rack Operations submenu.

To add an Expansion Unit to the system, select Add Module from the context-sensitive menu or from the Edit, Module Operations submenu. The Expansion Unit is added to the end of the chain.

To replace an Expansion Unit, select the Expansion Unit and choose Replace Module from the context-sensitive menu or from the Edit, Module Operations submenu.

To remove an Expansion Unit from the system, select Delete Module from the context-sensitive menu or from the Edit, Module Operations submenu. Only the last Expansion Unit in the chain can be deleted.

Note: The main module cannot be deleted from the system.

To remove all Expansion Units from the system, select Clear Rack from the context-sensitive menu or from the Edit, Rack Operations submenu.

When you add or replace a module, the Parameter Editor window will appear.

Counter, Pulse Width Modulation, and Pulse Train Output

To configure the High Speed Counter, Pulse Width Modulation, and/or Pulse Train Output functions, go to the Edit menu and select Module Operations, Configure Parameters, HSC/PWM/PTO. You can also choose Configure Parameters, HSC/PWM/PTO from the context-sensitive menu. A Parameter Editor window similar to the one shown below will appear (Nano PLCs have only three counter tabs.) For details on configuring these functions, choose Module Help from the Help menu.

HSC/PWM/PTO Settings	
Channel 1 Channel 2 Channel 3 Channel 4	
Parameters	Values
Counter Type:	4 Type A
Output Stop Mode:	Normal
Reference Address:	%I0489
Length:	24
Reference Address:	%Q0489

HSC/PWM/PTO

PWM Frequency and Duty Cycle

The frequency and duty cycle of the PWM output are specified from the application program. Pulse Train Output frequency is also controlled from the application program (duty cycle is nominally 50%).

For details on configuring and using these features, refer to Chapter 5 of the *Series 90 Micro PLC User's Manual*, GFK-1065.

Configuring Averaging Filter for Analog Input Potentiometers

VersaMax Micro PLCs have two potentiometers, located below the Run/Stop switch, that can be used to manually set input values that are stored in %AI16 and %AI17.

The number of samples to be averaged can be controlled by the application program. By default, 16 samples will be averaged.

For details on configuring and using this feature, refer to Chapter 8 of the *Series 90 Micro PLC User's Manual*, GFK-1065.

Hardware Configuration Reference View

HWC Reference View provides information about references allocated when modules are added to the rack system. This view is updated each time an I/O or specialty module is added to or deleted from the system.

The Reference View is a dockable view, which means that you can select it with your mouse and move it anywhere in the HWC main window. You can control display of the reference view. To display or hide the reference view, select the View menu and click Reference View.

The reference view maintains a separate tab for each reference type used in HWC (%I, %Q, %AI, %AQ, %G, %M, %R, ...). To view reference information for a specific reference type, click the tab that corresponds to that reference type.

%AI	%AQ	%G	%I	%M	%Q	%R	%S	%SA	%SB	%SC	%T
Overlap	Start	End	Addr	Mem Type	Catalog #						
	0001	0080	0.1	Consumed	IC693CPU364						
	0081	0144	0.2	Consumed	IC693DSM302						
	0145	0208	0.3	Consumed	IC693DSM302						
	0209	0272	0.4	Consumed	IC693DSM302						

Total %I: 0272 Highest: 0272 Limit: 2048

Each row provides reference point assignments for a specific module. The columns are configured as follows:

- **Overlap:** By default, non-fatal overlaps are identified in blue text and fatal overlaps are identified in red text.
- **Start:** Displays the starting reference point assignment for the module.
- **End:** Displays the ending reference point assignment for the module.
- **Addr:** Displays the module's Rack/Slot address in the form R.S where:
 - R is the relative rack number (0 indicates first, or main, rack)
 - S is the relative slot number within the assigned rack (0 indicates the leftmost slot)
- **Mem Type:** Identifies whether the module produces or consumes data in the allocated memory area.
- **Catalog #:** Displays the module's catalog number.

Hardware Configuration Log View

HWC offers a logging facility which records and maintains a history of HWC events and status information. The data is saved in a separate log file on the PC hard disk, and may be accessed through multiple edit sessions. The default size of the log file default is 1MB. If the log data exceeds this size, the oldest log information is overwritten with new log data.

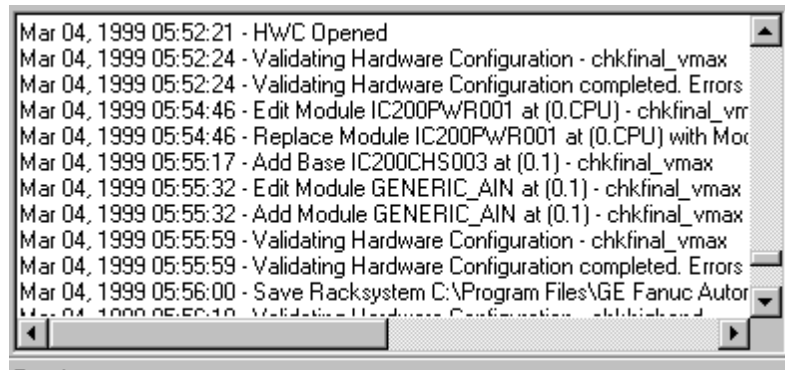

HWC provides two modes for recording log data:

- **Exception Only Mode:** Only warnings and exception conditions are recorded in the log.
- **Audit Trail Mode (default mode):** Informational messages (such as module deletes, adds, etc.) are recorded in the log, in addition to warnings and exception conditions.

To change the setting for the log file, select the Tools menu and choose Options. The Options dialog box will display, allowing you to set Audit Trail Mode and adjust the default log file size.

The Log View is a dockable view, which means that you can select it with your mouse and move it anywhere in the HWC main window. You can control display of the log view. To display or hide the log view, select the View menu and click Log View.

Hardware Configuration Power Consumption View

The Power view displays current power consumption statistics for the power supply that is providing power to the currently selected module. These statistics are provided to assist you in monitoring the power requirements of the I/O modules you are configuring in the individual racks.

To enable or disable docking, choose Dock from the popup menu. To change the color scheme, see Error Notification.

Following is a summary description of the power consumption statistics displayed:

- The bar graph shows the percentage of power used for each voltage and the total. The bar graphs show the percentage of power used for each voltage and, for Series 90-30 racks, the percentage of total system power used.
- For VersaMax racks, Used and Supplied power statistics are shown in Amps.
- For Series 90-30 racks, Used, Supplied power statistics are shown in Watts.
- AVL Ext (available externally) displays the external power available at each voltage and the total available external power in Watts. (Series 90-30 systems only)

Power Consumption Limit Calculations

The Power view displays graphs showing amount of consumption for the various voltages produced by the power supply. In addition, for Series 90-30 racks, the graph shows a system Total graph bar, which represents the percentage of overall total power supply capacity that is currently used. Please note that the system total is typically not a summation of all the voltages produced by the power supply, but rather, a lesser value.

The 90-30 power supplies are power limited, and therefore display units are Watts. Conversely, the VersaMax power supplies are current limited, and therefore display units are Amps.

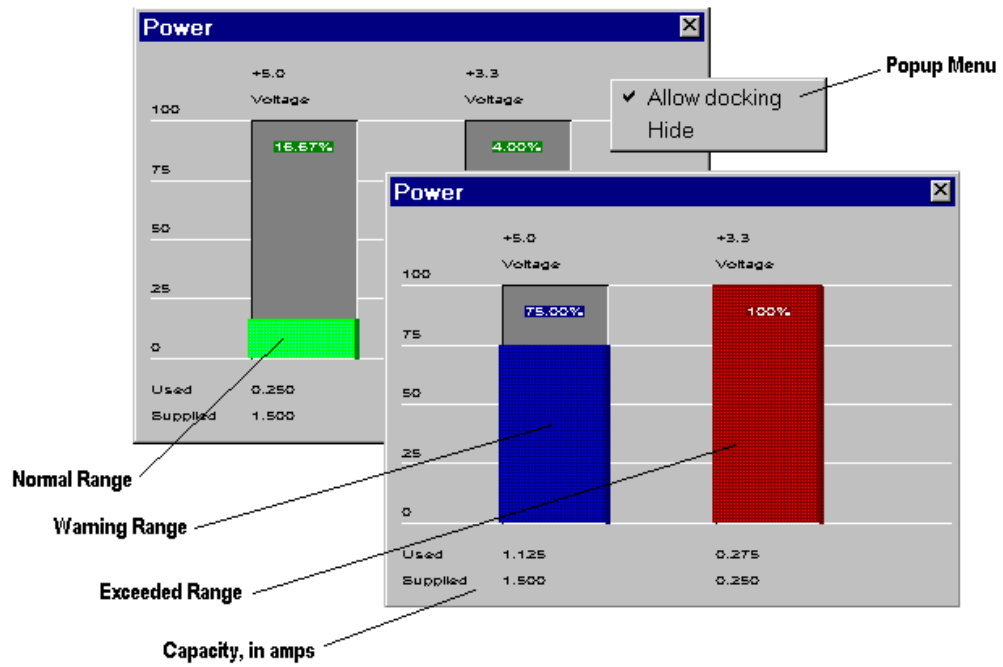

VersaMax Power View

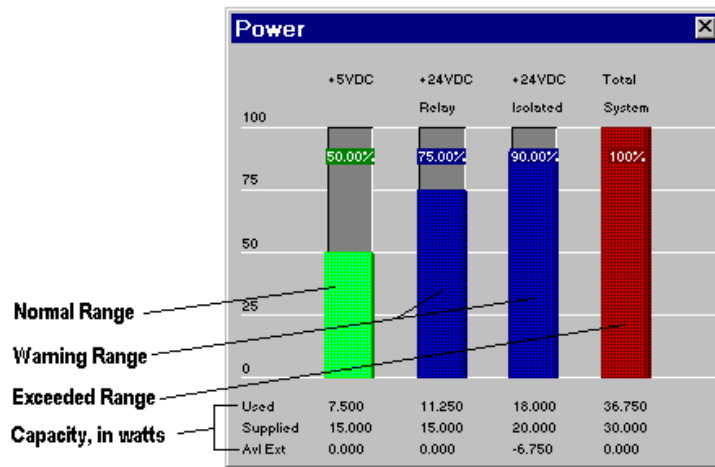

Series 90-30 Power View

Components of the Power Consumption View

Power Supply Whose Statistics are Displayed

This is always the most immediate leftmost power supply to the selected module. For a 90-30 System, the Power Supply will always be in slot 0, since there is only a single Power Supply per rack. For a VersaMax System, which supports multiple Power Supplies, the power supply can be in any slot and is the first one encountered traveling left from the selected module.

Normal Range

Power Consumption percentage bars representing less than 75% consumption are displayed in the Power Normal color (default is green).

Warning Range

Power Consumption percentage bars representing more than 75% to 100% consumption are displayed in the Power Warning color (default is yellow).

Exceeded Range

Power Consumption percentage bars representing greater than 100% consumption are displayed in the Power Error color (default is red). Note that if consumption is exceeded, the label at the bottom of the graph displays the actual amount used, but the percentage bar does not show greater than 100%.

Note: To change the normal, warning, and error colors in the Power View display, choose Options from the Tools menu.

Converting Rack Systems

The default hardware configuration is VersaMax. If this is not the type you plan to work with, the type can be changed using the following steps:

1. From HWC, select the File Menu and choose Convert To.
2. Select the PLC type that is available in the list.
3. A message box will appear, warning that I/O modules will not be carried over to the new rack system. Please note that this operation cannot be undone.
4. To continue with the conversion, click Yes. To abort the conversion and keep the existing hardware configuration, click No.

Note: To change the default hardware configuration, go to the Tools menu in the VersaPro window and select Options. On the General tab, change the Default Hardware Configuration to the type that you will be using.

Printing Hardware Configuration

You can print your Rack configuration by going to the File menu and choosing Print. To set print options, click the Range button in the Print dialog box. The following print options are available:

- You can choose to print hardware configuration information for the entire rack, or for a range of modules (selected by rack:slot).
- You can select to print overview or detail for the configuration:
 - Overview:** Prints the Rack as shown on the screen.
 - Detail:** Prints the parameter information for each module in the Rack.
 - Ethernet Global Data:** If your CPU is configured to participate in EGD exchanges, select this box to print EGD configuration for the CPU.
 - Reference Details:** Prints a table showing start and end memory locations, rack slot addresses, and other reference data.
 - Name Resolution:** For Series 90-30 CPU364 configurations using Name Resolution, check this box to print the Name Resolution configuration information.

If you want to change your target printer or paper size or orientation, click the Setup button in the Print dialog box.

VersaPro provides two View Tables for monitoring the real-time values and states of elements in the PLC:

- The Variable View Table allows you to group important variables into a window for online viewing.
- The Reference View Tables allows you to group important references into a window for online viewing.

Multiple View Tables may be open at once.

Chapter Contents

- Overview of Reference View Tables (RVT) and Variable View Tables (VVT)
- Information on creating and managing data in the view tables.

Variable View Tables – Overview

Variable View Tables (VVTs) allow you to monitor the states of variables. A folder may have zero or more mixed-type VVTs. VVTs and VVT entries can be cut and copied, and dragged and dropped between folders.

An example of a VVT is shown below.

The screenshot shows a window titled 'VarVu.vvt' containing a table with four columns: Name, Address, Scope, and Value. Callouts provide the following definitions:

- Name:** Displays variable name, which may be user-defined or match the Reference Address.
- Address:** Displays PLC reference address for each variable.
- Scope:** Shows variable scope: Global or Local:block.
- Value:** Displays PLC online value if you are connected to the PLC, with logic equal, and monitoring active.

Name	Address	Scope	Value
%I00081	%I00081	Global	
%R00216	%R00216	Global	
	%R00217		
%R00216	%R00216	Global	
	%R00217		
%AI0005	%AI0005	Global	

Only the Name column may be edited. All other columns are read-only.

The Value column is blank until the Folder is on-line and equal. The value cell displays “****” for variables that have no assigned reference address.

If the cell is too narrow to display the online value, the cell will display #####.

Reference View Tables – Overview

Reference View Tables (RVTs) contain a list of references that can be monitored and updated in real-time. A folder can have zero or more reference tables. RVTs can be cut and copied and dragged and dropped between Folders. More than one Reference Area can be entered into a single RVT.

The number of entries contained in an RVT does not affect the performance of the RVT. Performance is affected only by the number of entries that are displayed and have to be updated in the view.

Example RVTs are shown below.

Format of selected address

Selected address

Starting address

Signed Decimal								%R00216	Address
00000000	01000000	00000000	00100001	00100001	00000000	00000000	00000000	%I00081	
-15536	+0	-31072	+16	+1	+205	+8	0.0	%R00202	
+0	+20000	+0	-31072	+0	+1000	+0	-15536	%R00210	
00000000	00000000	00000000	00000000	00000000	00000000	00100000	00000000	%T00097	

Display format can be selected for individual cells

Binary								%I00019	Address
0100001	00000000	00000001	00000000	00000000	00100000	00000000	00000000	128 %I00009	
00000000	01000000	00000000	00100001	00100001	00000000	00000000	00000000	%I00081	
+0	+0	+0	+0	+0	+0	+0	+0	16#21C5 %AI0005	
+0	+0	+0	+0	+0	+0	+0	+0	+4 %AI0079	

All Reference Addresses are displayed that begin with the closest byte offset smaller than or equal to the starting address you enter and finish eight columns later (Ten columns of data are displayed for %R, %AI, and %AQ reference addresses.) The amount of data displayed in the columns depends on the format.

Note: Upon opening a folder created with VersaPro 1.00, the Reference View Tables will be converted to the new format. However, table format selections will be reset to the defaults.

Customizing View Table Display

You can customize font selection and color for VVTs and RVTs. Perform the following steps to customize the display:

1. From the Folder Browser, click the Tools menu and select Options. The Options dialog box will appear. Select the Display tab.

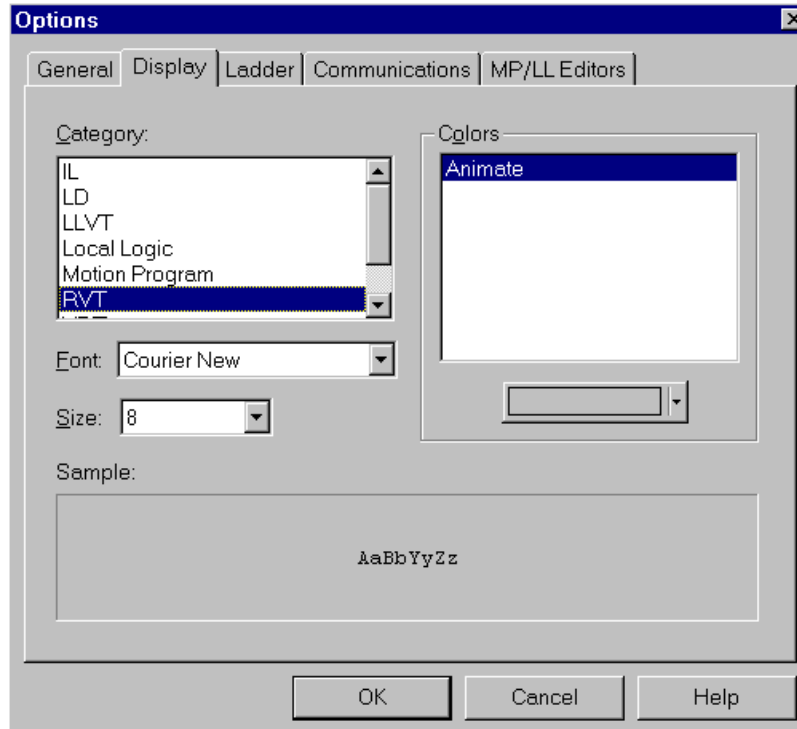

2. You can change the font selection and change the color used for the display of online values.
 - To modify the settings for the RVT, set the Category to RVT and make the desired changes. Click OK to accept.
 - To modify the settings for the VVT, set the Category to VVT and make the desired changes. Click OK to accept.

Changing Reference View Table Display Format

Your selections of Byte, Word, or Dword governs how much data is displayed in each cell. Formatting for an RVT occurs on a table, not a row, basis. Perform these steps to change the display format for a RVT:

1. Open the RVT.
2. Select the View menu and choose Format View Table. The Format Display dialog box will appear.

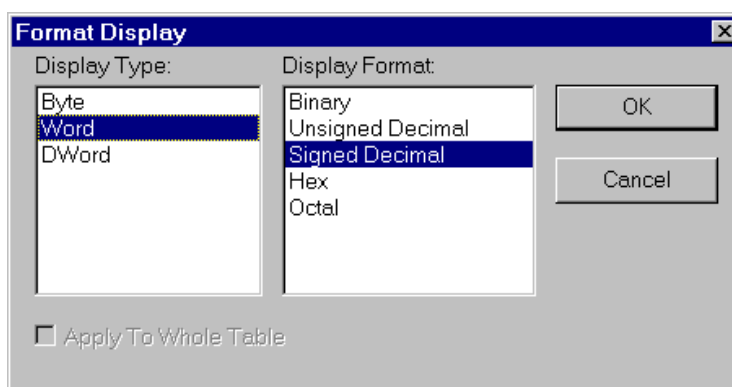

3. Select the Grouping and Display Format which suits your application needs:
 - Grouping Field
 - Byte (each cell contains 8 bits)
 - Word (each cell contains 16 bits)
 - Dword (each cell contains 32 bits)
 - Display Format
 - Binary
 - Hex
 - Octal
 - Unsigned Decimal
 - Signed Decimal
 - Real (Only available when Dword is selected)
 - Scientific Notation (Only available when Dword is selected).

You can change the display format of an individual cell by selecting the cell and choosing Display Format from the context-sensitive menu.

Customizing Variable View Table Display Format

You can customize the value display format for Variable View Tables. To change the display format for online values, perform the following steps:

1. Open the VVT. Select row containing the variable where you want to change the display format.
2. Click the right mouse button and select Display Format from the CSM..

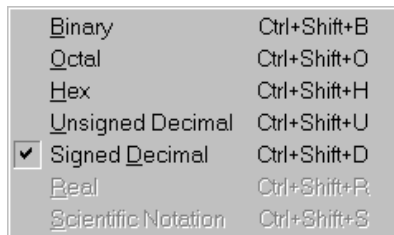

3. Change the display to suit your application requirements. The format is changed for the variable selected.

Note: If the value displays #####, increase the width of the value column to see the online value.

Creating New Reference and Variable View Tables

New Variable View Tables and Reference View Tables are created quickly from the folder browser. You can have multiple view tables in your folder. This section describes how to create new VVTs and RVTs.

To create a Variable View Table:

1. From the Folder Browser, click the right mouse button and choose New Variable View Table (or select the File menu and choose New Variable View Table). The New Variable View Table dialog box will appear:

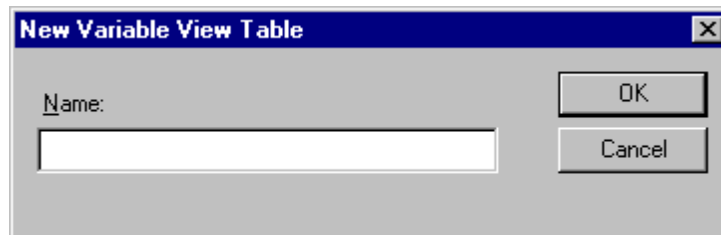

2. Enter a name for the VVT. Click OK to accept.
3. The new VVT is created and displays in the folder window. The new VVT icon is added to the Folder Browser with the VVT name.

To create a new Reference View Table:

1. From the Folder Browser, click the right mouse button and choose New Reference View Table (or select the File menu and choose New Reference View Table). The New Reference View Table dialog box will appear:

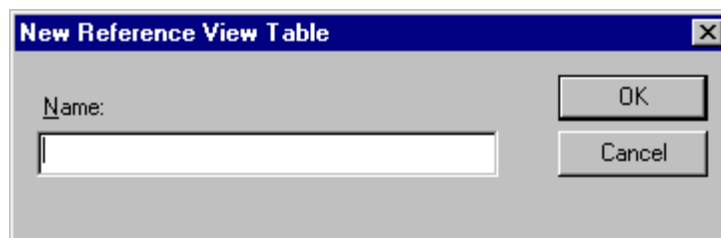

2. Enter a name for the RVT. Click OK to accept.
3. The new RVT is created and displays in the folder window. The new RVT icon is added to the Folder Browser with the RVT name.

Note: Offsets columns are not populated until you are connected to the PLC and have enabled Monitoring.

Adding Elements to a View Table

You can add logic elements (references or variables) to a View Table for online monitoring.

You may be either off-line or on-line when you add a new entry to a Variable View Table. If you are on-line and equal to the PLC, the new variable's data updates automatically.

Adding an Element by Direct Entry to a VVT

1. From the Folder Browser, open a VVT.
2. Select the Name field on a blank line in the VVT.
3. Select a variable using the Name field's drop-down list, or type in a valid variable name.
4. Press Enter, or select another field. The entered variable and corresponding columns (address and scope) are displayed in the VVT.

Valid VVT Variable Entries

Valid variable entries may consist of any of the following:

- name
- address (If only an address is typed into the Name field, that address will appear in both the Name and Address fields.)
- name, address (The Scope will default to global.)
- name, g (The scope will be assigned as Global.)
- address, g
- name, address, g
- name, local: scope (Scope is the block to which the variable should be locally assigned. For example, to assign a variable with the name "A" locally to a block named "B", type "A,local:B" in the Name field.)
- address, local: scope
- name, address, local: scope

The length of a variable in a View Table reflects the length that was entered into the Variable Declaration Table. Changes to length may only be made through the VDT. Information may not be entered directly into the Address or Scope fields.

Adding an Address to a Reference View Table

1. From the Folder Browser, open an RVT.
2. On a blank line, select the Reference Address column. Type a reference address in one of the following formats (%I00001 , I1)
3. Press Enter, or select another field. The reference and corresponding columns are displayed in the RVT.

Valid RVT Entries

- Word Memory areas (R, AI, AQ) begin with the address you enter.
- The same reference address may be entered and displayed more than once.
- If a value is too large to display in the current cell width, “#####”s appear until you increase the column width so that the entire value can be displayed.
- Valid offsets range from 0-99999. If an entered offset exceeds the maximum, an error message appears informing you of the maximum value and the fact that it has been exceeded. Monitoring within an RVT can not take place until all offsets are determined to be within the limits of the PLC.
- If an offset is valid, but data is not available, a 0 displays. If the offset is not valid, the cell remains blank.

Adding a Range to a Reference View Table

1. Open an RVT by double-clicking on it in the Folder Browser.
 2. On a blank line, select the Reference Address column .
 3. Enter the first address in the range, a comma, and then the last address in the range. Multiple reference addresses must be separated by commas. Entering an invalid multiple range Reference Address results in an error.
- The same reference address range may be entered and displayed more than once.
 - Valid offsets range from 0-99999. If an entered offset exceeds the maximum, an error message appears informing you of the maximum value and the fact that it has been exceeded. Monitoring within an RVT can not take place until all offsets are determined to be within the limits of the PLC.
 - If an offset is valid, but data is not available, a 0 displays. If the offset is not valid, the cell remains blank.



Modifying Information in a View Table

VersaPro allows you to edit the variables contained in a View Table by changing the Name of a variable. Changing the Name in a View Table selects a different variable from the VDT, and replaces the existing variable in the View Table. True changes to a Name must be made in the VDT.

To write a value to a reference, select the cell corresponding to the reference in the VVT or RVT, and type the new value. (You can also place the view table in edit mode by double clicking in the cell, pressing F10 or choosing Write from the PLC menu.)

Editing Operations in View Tables

Using cut, copy, paste in a VVT

1. Open the VVT from which you wish to cut a variable entry or entries.
2. Select at least one cell within each row that you wish to cut.
3. Choose Cut or Copy from the Edit menu, click the Cut  or Copy  button, or press Ctrl + X to cut or Ctrl + C to copy.
4. All rows entirely selected are removed from the VVT and placed on the clipboard in VersaPro list format (not as text), and other rows shift to fill the cut space.
5. If you want to insert the variables between existing variables on the destination VVT, rather than overwrite existing variables, select any cell in the row beneath the desired insertion point.
6. If you want to overwrite existing variables, select the rows that you wish to overwrite.
7. Choose Paste from the Context-Sensitive or Edit menu, click the Paste button , or press Ctrl + V. If the variables are inserted, they appear in a new row above the row in which a cell is selected, and are appended to any other affected table(s). If the variables overwrite previously-existing variables, they appear in the position of those variables.

Details on Cutting and Copying

- Variables cut or copied from a VVT can be pasted only in the same or another view table. They can also be pasted between view tables in different folders.
- Cutting or copying a variable in a VVT does not affect the VDT.
- Variables can be cut or copied during monitoring.
- Text can be pasted into the name field only when it is in edit mode.

Note: Only entire rows may be cut. Selecting any cell in a row, and then cutting, results in cutting the entire row.

Details on Pasting

- If more variables reside on the clipboard than have been selected to be overwritten, the selected variables are overwritten and the remaining clipboard variables are inserted into the table.
- If fewer variables reside on the clipboard than have been selected to be overwritten, as many of the selected variables as possible are overwritten, and the rest are deleted.
- When you paste to a second instance of a VVT, a new variable is created in the VDT.
- If collisions occur when creating variables in the VDT, an error message appears describing the problem.
- Click OK. A dialog appears allowing you to correct the problem.
- Correct the problem. Row validation continues for other variables. If you cancel, the entire paste is cancelled.

To drag and drop-cut in a VVT:

1. Open the VVT from which you wish to cut a variable entry or entries.
2. Select at least one cell within each row that you wish to cut.
3. Position the mouse arrow over the selected row.
4. Press and hold the primary mouse button.
5. Move the variable or cell to the appropriate area.
6. A graphical representation of the selected area is displayed to indicate a selection is being dragged. This representation changes dynamically when you drag between two instances of the VVT which have different cell dimensions.
7. To drop the selection, release the mouse button. If it is valid in the new location, the selected variable or cell is removed from the original position and placed in the new position. If it is not valid, the drag and drop operation is cancelled.

To drag and drop-copy in a VVT:

1. Open the VVT from which you wish to cut a variable entry or entries.
2. Select at least one cell within each row that you wish to cut.
3. Position the mouse over the selected variable or cell.
4. Press and hold the Ctrl key.
5. Press and hold down the primary mouse button.
6. Move the variable or cell to the appropriate area.

7. A graphical representation of the selected area is displayed to indicate a selection is being dragged. This representation changes dynamically when you drag between two instances of the VVT which have different cell dimensions.
8. To drop the selection, release the mouse button. If it is valid in the new location, the selected variable or cell is copied from the original position and placed in the new position. If it is not valid, the drag and drop operation is cancelled.

Details on Dragging and Dropping in a VVT

- Selections may be dropped on any part of a row.
- If a section is dropped on the last row of the VVT that would go beyond the last row of the table, new rows are created to accommodate the drop.
- Variables can be entered more than once within a VVT.
- If a selection is dropped that would go beyond the last row of the VVT, new rows are created to accommodate the drop.
- When a selection is dropped, it overwrites the existing cells.
- VersaPro does not allow dragging and dropping a discontinuous set of cells.
- When you drop to a second instance of a VVT, a new variable is created in the VDT.
- If collisions occur when creating variables in the VDT, an error message appears describing the problem.
- Click OK. A dialog appears allowing you to correct the problem.
- Correct the problem. Row validation continues for other variables. If you cancel, the entire paste is cancelled.

Saving View Tables

It is important to save changes to both RVT and VVTs when editing. This section describes how to save View Tables.

Online values are not saved with view tables. Online values are maintained in the PLC and are displayed in the view tables.

To save changes when editing a view table, Select the File menu and choose Save, or click the Save toolbar button. 

Online Viewing

To view online values for view tables, the folder must be open and you must be connected with the PLC. In addition, the View Table window must be monitoring PLC data. To set the View Table to monitoring, click the Monitor All or Monitor Active toolbar buttons.

This section provides details about window behavior when working online and describes how to change values online.

Details about Online Viewing

- If the value is too large to display in the current Value column cell width, "#####" displays until the column width is altered.
- Override status is displayed as an underlined value (as in both editors).
- Overriding and toggling variables is done through the right mouse menu.
- Array Variables (variables with a length greater than 1) display the address, scope, and value on subsequent lines under the first entry.

To Toggle or Override a Reference in an RVT

To work online in the RVT, connect to the PLC and perform the following steps to toggle and override references.

1. Open the RVT. Select the View menu and choose Monitoring -> All or Monitoring -> Active Window.
2. Place the cursor on an offset of the reference that you want to toggle or override.
3. Select the PLC menu and choose Toggle, press the F12 key or click the Toggle button. . The RVT Override/Toggle Bit dialog box will appear.
4. To override, press the F11 key or click the Override button. The appropriate reference is toggled or overridden.

To Write a Value to a Reference in an RVT

1. Open the RVT. Select the View menu and choose Monitoring -> All or Monitoring -> Active Window.
2. Place the cursor on an offset of the reference that you want to change.
3. Select the PLC menu and choose Write Reference Value, or click the Write Reference Value button. .
4. Enter the value. Click the OK button to accept. The value is written to the reference address in the PLC.

Chapter 9

Motion Programming

The Motion Mate DSM314 is a high performance, easy-to-use, multi-axis motion control module that is highly integrated with the Series 90-30 PLC logic solving and communications functions. VersaPro provides the following capabilities:

- **DSM314 Configuration.** Allows you to select module settings and default operational parameters using SAHWC.
- **Motion Editor.** Used to create and modify Motion programs. A Motion program consists of a series of motion command statements that are stored to and executed in the DSM314. Up to 10 Motion programs and 40 subroutines are allowed.
- **Local Logic Editor.** Used to create and modify Local Logic programs, which run synchronously with the Motion program, independently of the PLC's CPU scan. This allows the DSM314 to interact much more quickly with motion I/O signals than if the logic for these signals was handled in the main ladder program running in the PLC.
- **Cam Editor.** Used to create, edit, and manage Cam profiles. A Cam profile specifies the response of a slave servo (follower) to a master position index and is referenced by name in the associated Motion program. Cam profiles are grouped into Cam blocks which are downloaded to the DSM314 module via the PLC.

The Motion, Local Logic, and Cam editors are accessed from the Folder Browser. Motion, Local Logic, and Cam blocks can be dragged, cut, copied, etc. within the Folder Browser the same as other program blocks, as described in chapter 3. Once created and saved, Motion, Local Logic, and Cam programs become part of the hardware configuration and are Stored to the PLC with the other configuration information. For additional information about configuring and programming the DSM314, refer to the *Motion Mate DSM314 for Series 90-30 PLCs User's Manual*, GFK-1742.

Chapter Contents

- Setting Motion Program/Local Logic Editor Options
- Using the Motion Program Editor
- Using the Local Logic Editor
- Using the Local Logic Variable Table (LLVT)
- Saving Motion/Local Logic Programs
- Printing Motion/Local Logic Programs
- Storing Motion Programs and Subroutines to the PLC
- Restoring Motion and Local Logic Blocks
- Using the Cam Editor

Setting Motion Program/Local Logic Editor Options

1. Choose Options from the Tools menu, or from the Editor CSM.
2. The Options dialog box appears.
3. Select the MP/LL Editors Tab.

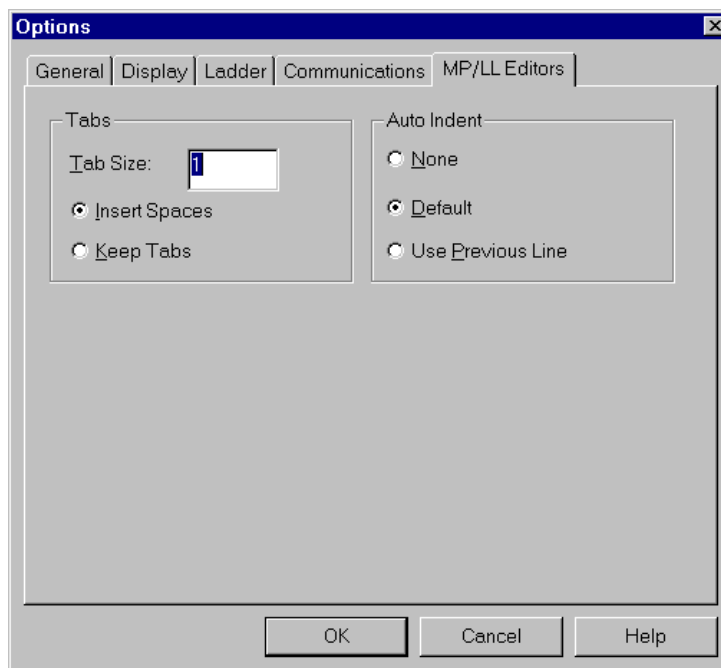

4. Select the tab and auto-indent options you want and click OK.

Using the Motion Program Editor

To Open the Motion Program Editor

- Click File on the menu bar, select New Motion, then Motion Program.
- The Create New Motion Program dialog box will appear.

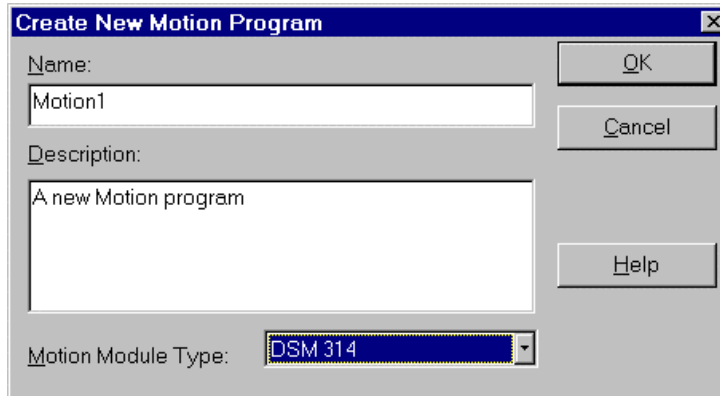

- Type the motion program Name and Description. If more than one motion module type is available in the drop-down listbox, select the motion module type that indicates the module type on which this program will be run. Then click the OK button. The Name is required. The Description is optional. A Motion Editor window for the new motion program block will open. The motion program name appears as the title of the Motion Editor window and an icon for the new motion program appears in the Folder Browser window.
- The text-based motion programs and subroutines are created in the Motion Editor window, as shown in the following figure. Ten motion programs and forty subroutines, maximum, separated by their identifying headers (such as “PROGRAM 1 MULTI-AXIS”), can be programmed in the same editor window and are stored in the same motion program block.

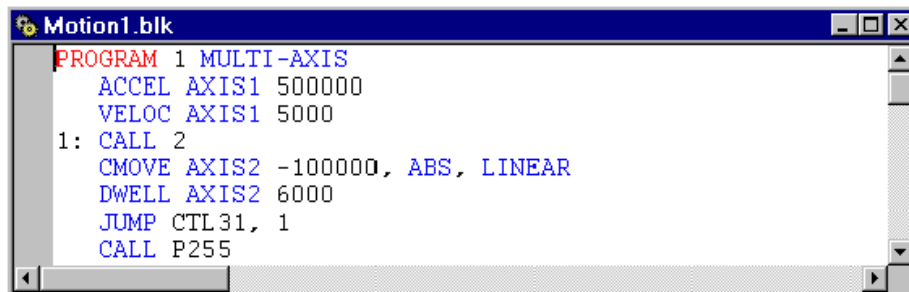

Creating Motion Program Logic

The DSM314 supports 10 motion programs, 40 subroutines, and a maximum total of 1000 motion program statements. Comments and white space are not considered as motion program statements.

Basic Requirements

Format

- Motion programs and subroutines are written using ASCII text.
- Only one motion language statement is permitted per line, and a motion language statement may not span more than one line. Normal comments may span multiple lines.
- White space and blank lines may be used to improve readability and to separate certain items.
- The Motion Editor is not case sensitive.
- All motion programs and subroutines must be contained in a single, motion program block.

Single axis and multi-axis programs and subroutines

A given single axis program must be able to run on any one axis specified in the Program definition statement. Therefore, motion language commands in single axis programs and subroutines will not specify an axis. Rather, the axis specified in the PROGRAM statement is used for all motion commands and subroutines called in the program. Multi-axis programs and subroutines can only call multi-axis subroutines. Likewise, single axis programs and subroutines can only call single axis subroutines. A multi-axis motion program is valid only for axis 1 and axis 2. Axis 3 and 4 if enabled in configuration must be programmed as single axis programs only.

Note: CAM instructions are not valid in Multi-Axis programs.

Program and subroutine definition statements

The Motion Editor requires “Program” and “Subroutine” statements that specify program/subroutine number and axis configuration (PROGRAM 1 MULTIAXIS or SUBROUTINE 2 MULTIAXIS). These statements are placed on the first line of the program or subroutine. Programs are terminated with an ENDPROG statement, subroutines are terminated with an ENDSUB statement. These statements serve as separators between programs and subroutines, identify the program and subroutine numbers, and indicate the type of program (single axis or multi-axis).

Block numbers and sync blocks

Block numbers will be suffixed with a colon (10: for example). Block numbers may appear alone on a line or preceding a motion command on the same line.

Sync blocks (blocks containing a SYNC instruction) are identified by a line with a block number followed by the SYNC command (20: SYNC for example).

The SYNC (synchronize block) command is used in multi-axis programming to synchronize two axes at designated points. For additional information, refer to the *Motion Mate DSM314 for Series 90-30 PLCs User's Manual*, GFK-1742.

Using the Local Logic Editor

To Open the Local Logic Editor

- Click File on the menu bar, select New Motion, then select Local Logic Program.
- The Create New Local Logic Program dialog box will appear.
- Type the Local Logic program Name and Description, select the module type, then click the OK button. The Name is required, the description is optional. A Local Logic Editor window for the new program block will open. The program name appears as the title of the Local Logic Editor window and an icon for the new program appears in the Folder Browser window.

Local Logic Commands

The local logic language uses free-format text based constructs derived from the IEC 1131 structured text standard.

The local logic syntax is easy to learn and provides a rich feature set that allows you to accomplish the programming task. For details about Local Logic programming, refer to *Motion Mate DSM314 for Series 90-30 PLCs User's Manual*, GFK-1742.

Using the Local Logic Variable Table

Local Logic accesses the DSM314 motion controller variables and parameter registers using pre-defined variable names. The Local Logic Variable Table (LLVT) displays these variables, which are organized into six tabs: Axis 1 – 4, Global, CTL Bits, and Parameter Registers.

Each set of Axis variables contains **Control variables**, **Status variables** and **Faceplate I/O**.

Tips for working in the LLVT

- To change the width of a column, select and drag the divider on the right side of the column head.
- To copy the contents of a selected area in the LLVT to the Clipboard, press Ctrl + C or choose Copy from the CSM. To select a single cell, simply click in it. To select a block of adjacent cells, click and drag, or click, hold the Shift key, and click again. You can select rows or columns by clicking or clicking and dragging the border at the top or left side of the table. Select the entire table by clicking the upper left corner.
- To sort the LLVT, click in the column you want to sort by, then choose Sort from the CSM or from the View menu. Choose Ascending or Descending from the submenu that appears.
- To print the LLVT, select the LLVT and choose Print from the File menu or press Ctrl + P.

To open the Local Logic Variable Table

To open the LLVT, select Local Logic Variable Table from the View menu, press Alt + 6, or click the Toggle Local Logic Variable Table button on the toolbar. 

Information Provided by the Local Logic Variable Table

The LLVT contains the following tabs: Axis 1, Axis 2, Axis 3, Axis 4, Global, CTL Bits, Parameter Registers

Each tab provides the following information:

Name

This column contains the variable name, which can be used within a local logic program.

Type

The data type for this variable.

Attempting to write a value larger than a given variable size will result in the value being truncated. For example, if the result of a math operation is 32 bits long and is assigned to a 16 bit variable only the low 16 bits will be stored. The Parser reports a warning if a Bit Operand is used as the destination variable in a non-Boolean Math operation (only the least significant bit of the result would be stored).

Local Logic variables that are less than 32 bits long are either **Signed** or **Unsigned** (except Bit Operands which are always Unsigned). All Math/Logic operations in the Logic Engine are signed 32 bit operations (except the 64 bit signed Divide and Modulus operations). Signed variables that are less than 32 bits long are automatically sign extended to 32 bits when they are loaded by the Logic Engine. Unsigned variables are not sign extended. Thus the Logic Engine handles all data conversion and limit checking automatically.

Note: The immediate command (%AQ) variables (Torque Limit, Velocity Loop Gain, Follower Ratio, Position Increment, and Position Loop Time Constant) may have an allowed range that is smaller than the Local Logic variable size. The module reports a warning error code and rejects any invalid values if the program attempts to write a value outside the valid range of an immediate command. Refer to the *Motion Mate DSM314 for Series 90-30 PLCs User's Manual*, GFK-1742 for a description of the allowed range for each immediate command.

Group

Each set of axis-specific variables contains Control variables, Status variables and Faceplate I/O. (The Global tab contains only Global variables.)

Description

This column contains a description of the variable. To view the complete description, hover the cursor over the cell, refer to the *Motion Mate DSM314 for Series 90-30 PLCs User's Manual*, GFK-1742.

R

If this column is checked, the variable can be read by a local logic program.

W

If this column is checked, the variable can be written to by a local logic program.

Note: Variables can be **Read-Only**, **Write-Only** or **Read-Write**. The Parser reports an error if you attempt to write to a Read-Only variable or read from a Write-Only variable.

Saving Motion/Local Logic Programs

When ready to save your motion program/subroutine file to your computer's hard disk, either click the Save icon on the tool bar (looks like a floppy diskette), or click File from the Menu bar and click Save.

Printing Motion/Local Logic Programs

There are two ways to print a motion program. You can use either the Print function or the Print Report function. Both of these items may be found on the File menu.

To use the Print function, with the Motion Editor active, click File on the menu bar and select Print. The Printer dialog box will appear. Make any desired printer setup changes, then click the OK button.

To print all motion programs as part of a report with other information in the folder, click File on the menu bar and select Print Report. The Print report dialog box will appear. Click the Blocks checkbox on the Print Report dialog box. Both motion program and local logic blocks will be printed as part of this report.

If you want to print only selected motion program blocks, highlight those blocks in the browser, then click File and select Print Report. Check the Blocks checkbox and then choose the Selected radio button. This limits the report to only those blocks that you have selected.

Storing Motion Programs and Subroutines to the PLC

Motion, Local Logic, and Cam programs are stored as part of hardware configuration. To store motion programming, first put the PLC in STOP mode. Then choose Store from the PLC menu. In the dialog box, select Store Hardware Configuration and Motion to PLC.

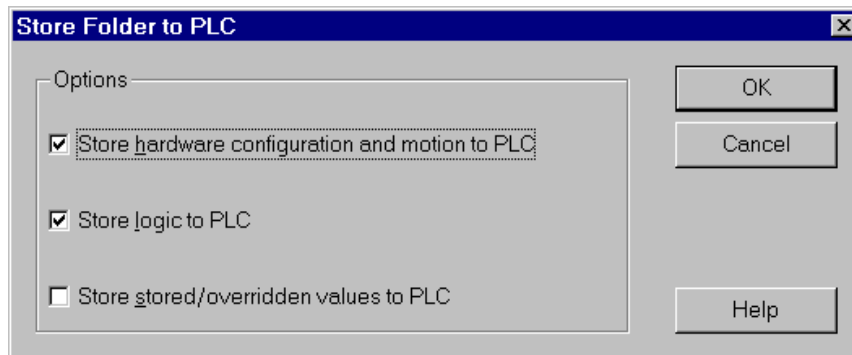

Restoring Motion and Local Logic Blocks

Backup copies of motion and local logic blocks in the open VersaPro folder are automatically made when you load the PLC configuration, including all motion and local logic programs from a PLC containing blocks of the same name. VersaPro will only create these backups if there is a difference between the motion/local logic block stored in the folder and the block stored on the PLC. A user prompt will ask if you wish to create the backups. The backup is one deep. Multiple backups of a single block are not automatically made. This restore mechanism provides a method of recovering modified motion program blocks from the PLC without the loss of comments stored in the VersaPro folder. Comments are not stored to the PLC and are available only if the VersaPro folder containing the comments is available.

To restore a Motion (*.mbk) or Local Logic (*.lbc) block:

1. Choose Restore Motion Blocks from the Folder menu.
2. The Restore Blocks dialog box will be displayed. The Available Blocks list contains a list of all backups of the motion and local logic blocks found in that folder. You can select one or more blocks to restore. If the PLC and VersaPro folder motion blocks are the same during the load from PLC process, motion backups will not be made and the list will be empty. However, if this is not a first time load and there were motion block differences between the PLC and the VersaPro folder, those backups will be displayed in the list. In other words, when you restore a backed up motion block, the backup remains in the folder and will be displayed in the list unless you physically remove it.
3. To restore a single motion block, highlight the block and click the Add button.
4. To restore multiple blocks, either select the Add All button, or press the Ctrl or Shift key and use the mouse to select blocks or sections of the list. Then, click the Add button.
5. If you want to remove a block from the Blocks to Restore List, select the block and click the Remove Button.
6. To remove all blocks from the list, click the Remove All button.
7. To remove a set of selected blocks, press Ctrl or Shift key and click to select the blocks and then click the Remove button.

-
8. When you are satisfied with the list, click the OK button. The blocks in the folder (that have been loaded from the PLC) will be replaced with the backups (from the VersaPro folder) you selected.
 9. To cancel the replace operation, click the Cancel button.

Note: When the block is restored, the backup is not deleted. If you are running out of disk space and don't want to keep backups, you must use the MS-Explorer or My Computer to navigate to the folder and manually delete the backup. Backups have an .mbk (motion) or .lbk (local logic) extension.

Using the Cam Editor

The Cam editor provides a means to create, edit and manage electronic Cam profiles for DSM314 motion modules. Each Cam profile specifies the response of a slave servo (follower) to a master position index. Cam profiles are referenced by name in the associated motion program.

Cam profiles are grouped into Cam blocks; each block is intended for download to the DSM314 module via a PLC controller. A block can contain up to 40 profiles.

Installing the Cam Editor

Note: You must have Internet Explorer 5.0 installed on your computer in order to install the Cam editor..

The CAM editor is installed as a separate tool.

1. It is recommended that you close all applications including virus checking, Internet Explorer, and CIMPLICITY HMI software that might be running in the background. You may need to check the task manager to determine if other applications are running.
2. Put the Cam Editor CD in the CD-ROM Drive.
3. Select the CD drive from Windows Explorer.
4. Run setup.exe to start the installation process
5. Follow the user prompts to complete the installation.

Starting the Cam Editor

You can open the Cam Editor by adding a new Cam block to the folder or double clicking an existing Cam block. You can also open the Cam Editor by choosing Cam Editor from the Tools menu.

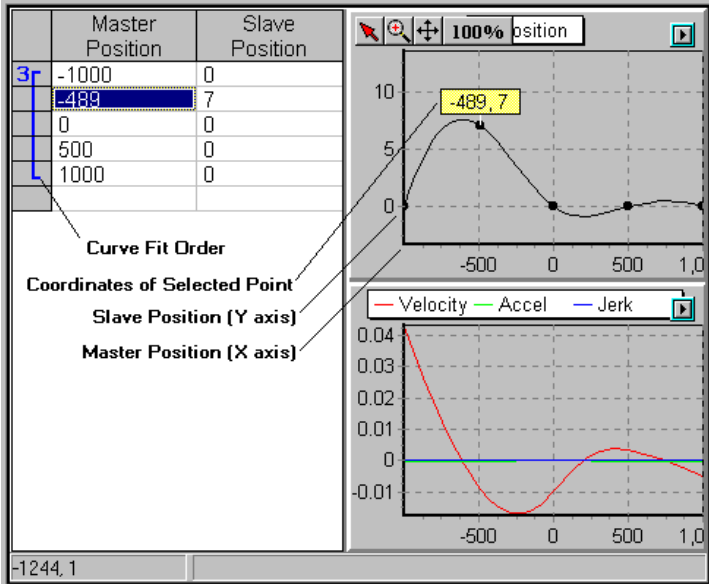

Sample Cam Profile

Adding a Cam Block to the VersaPro Folder

To add a Cam block to your VersaPro folder, click File on the menu bar, select New Motion, then Cam Program. The Create a New Cam Program dialog box will appear.

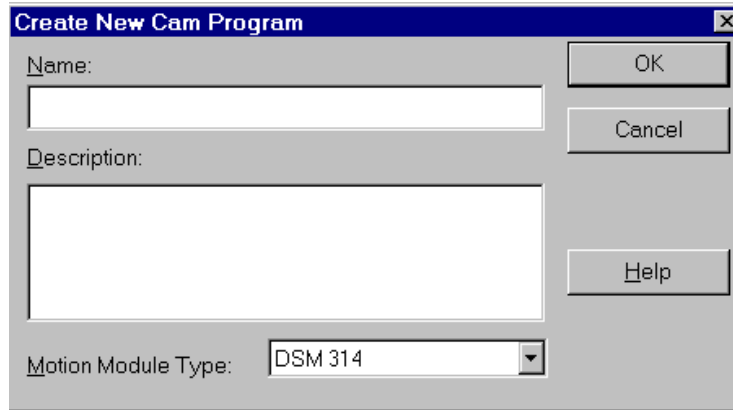

Type a name and a description for the Cam block and click OK. The Cam Editor will open and an icon for the new Cam block will appear in the folder browser.  Example - CAM

Note: If the Cam Editor is already open, you can also create a new block in the Cam Editor project browser. The new block will automatically appear in the VersaPro folder browser.

Opening an Existing Cam Block

To open a Cam block, double click its icon in the Folder Browser.  Example - CAM

The Cam Editor window will appear. Refer to the FrameWorX InfoViewer for details on developing profiles and creating links to profiles in Cam blocks.

Deleting a Cam Block

To delete a Cam block from the VersaPro folder, select the block in the folder browser and press the Delete key, or choose Delete from the Edit menu or CSM.

Duplicating a Cam Block

To duplicate a Cam block, select it in the folder browser and choose Copy (Ctrl + C) from the Edit menu or CSM. You can paste (Ctrl + P) the block into the same folder or a

different folder. If you paste it into the same folder, you will be asked to provide a new name. (Each component in the folder must have a unique name.)

Viewing and Editing Cam Block Properties

To view the name, description, and module type for a Cam block, select Properties from the Edit menu or the CSM. The Name and Description can be edited at any time. DSM314 is the only module that supports Cam blocks.

Renaming a Cam Block

To rename a Cam block, select the block, then choose Properties from the Edit menu or CSM, or press Alt + Enter. Type a new name in the Cam tab of the Properties dialog box.

Using Cam Profiles in a Motion Program

Cam profiles are referenced by name in the associated Motion program. Cam profiles are grouped into Cam blocks which are downloaded to the DSM314 module with the hardware configuration, via the PLC.

For a Cam profile to function in a Motion program, the following conditions must be met:

- The specified profile must be defined in the Cam Library and linked to a Cam block (using the Cam Editor). To execute the profile on a DSM314, this must be the Cam block specified in the hardware configuration.
- A Cam block that contains the profile must be defined in the VersaPro equipment folder. This can be done in the Cam Editor or in VersaPro (go to the File menu and choose New Motion, Cam Program).
- The Cam block containing the profile must be specified in the DSM314 hardware configuration and stored to the PLC.
- The profile name referenced in the Motion program must match the name defined in the Cam Library.

For details on using Cam profiles in a Motion program, refer to the user documentation for the DSM314.

Three instructions are available for programming Cam motion: CAM, CAM-LOAD, and CAM-PHASE.

Note: CAM instructions are not valid in Multi-Axis programs.

Chapter 10

Communicating with the PLC

Communicating with the PLC is necessary to perform such operations as storing and loading programs or viewing reference or PLC status information. This chapter describes how to connect to the PLC and perform some basic online operations.

Chapter Contents

This chapter provides the following information:

- How to connect your computer to the PLC using the Communication Configuration Utility (CCU)
- Guidelines for Communications Configuration
- How to transfer Folders to and from the PLC
- How to clear Folder data from the PLC and verify PC/PLC Folder information
- How to read/write/verify flash memory
- How to read/write/verify the EZ Program Store device (VersaMax CPUs)
- How to view PLC status information
- How to place the PLC in Run or Stop mode
- Monitoring logic execution

Connecting to a PLC

You can connect to a PLC from VersaPro over a serial or Ethernet connection, depending on the capabilities of the PLC. Connections are made by identifying a device and selecting a port. The device specifies information necessary to successfully connect including the default PC communication port, target PLC type, PLC SNP address and PLC IP address. The port identifies the PC port used to initiate communications to the PLC.

This section describes the various ways to connect to the PLC: Direct Serial Port, Multidrop and Modem Connections, and TCIP/IP.

Direct Serial Port Connection

The simplest method of communicating with the PLC is SNP Direct. To make it easy to connect SNP direct, a preconfigured device name, DEFAULT, is provided. DEFAULT is designed to be used for a direct connection from your PC to a PLC, connecting from COM1 on the PC to the built-in SNP port on the PLC. This device will work for any SNP direct connection using default protocol settings (19200, odd parity, 1 stop bit).

To connect directly from COM1 on your PC, follow these steps:

1. Connect the serial cable from COM1 on your PC to the RS-232/RS-485 converter on your PLC.
2. Select the PLC menu and choose Connect. The Connect dialog box will appear. This dialog box is used to select a device and port to initiate communication with the PLC.

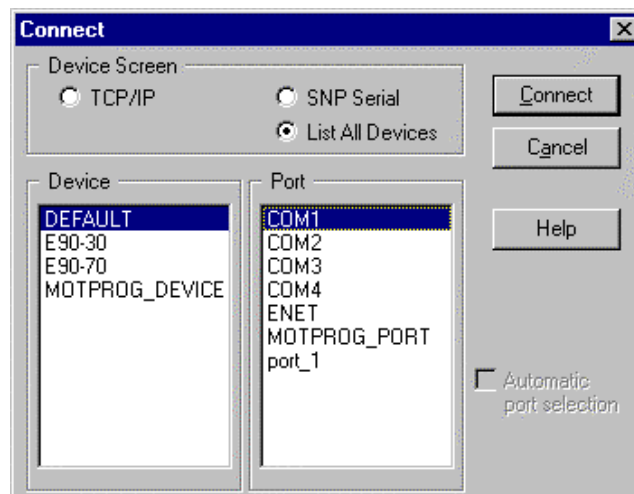

3. Select Device "DEFAULT" and Port "COM1". Click the Connect button to establish communications.

Multidrop and Modem Connections

If a Multidrop or Modem configuration has never been defined for a device, or your PLC hardware configuration has not been set to support these connections, follow the instructions below.

The physical connection from PC to PLC will depend on your application; see Appendix B, “Communications Cabling,” for details about cables and connectors.

Configuring Your Device and PLC CPU

If your application requires that you change the default serial port settings from the SNP default (19200, ODD, 8 Data Bits, 1 Stop Bit) or set an SNP ID, do the following:

1. Start Hardware Configuration (HWC) and double-click the PLC CPU.
2. From the Parameters dialog box, click the Settings tab:
3. Make the appropriate changes to your serial port settings and/or SNP ID and click the OK button.
4. Store the hardware configuration changes to the PLC.

Once you have made any necessary changes to the SNP default settings for the PLC CPU, you need to change the settings for the PC port. Follow these steps to modify port configuration for the PC.

5. From the Tools menu, choose Communications Setup. (If a password has been defined for the CCU, the Password dialog box will appear. Enter your password and press OK to continue.) The main screen of the CCU will appear.
6. To add a new device, click the New button. The Add New Device dialog box will appear:
7. Set the Default Port to match the PC port you will be using (COM1 through COM4) and enter the SNP ID for the PLC, if one exists. Click OK to add the device.
8. To change default serial port settings, click the Ports tab, highlight the PC port you want to modify (COM1 through COM4) and click Edit. The Edit Port dialog box will appear. Customize the port configuration to suit your application. (SNP timers may be accessed by clicking the Advanced button). Click OK to save changes for the port.

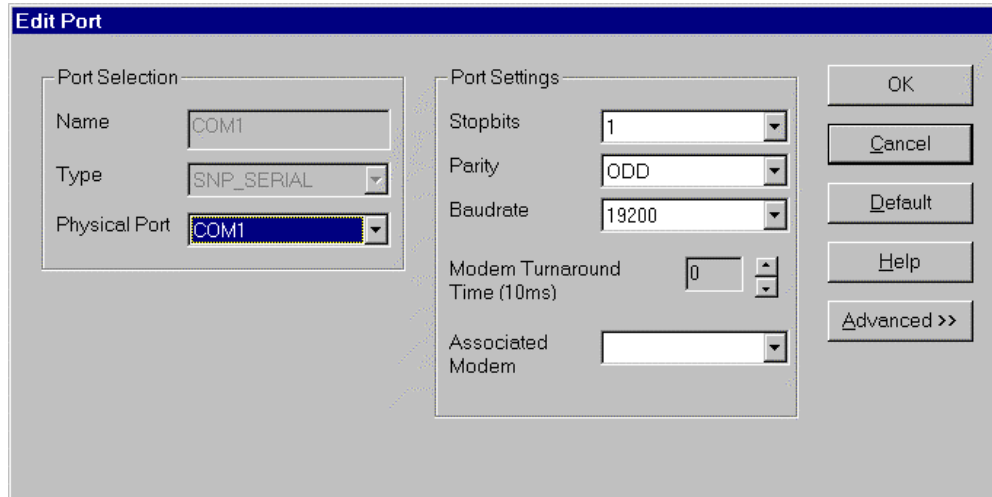

9. Set your PC port (COM1 through COM4) and enter your SNP ID, if one exists for your PLC SNP port. Enter NULL if there is no SNP ID. Click OK to add the device.

Connecting to the PLC

To connect to the PLC:

1. From the Folder browser, select the PLC menu and choose Connect (or click the Connect button  on the PLC toolbar).
2. Select the Device name and Port name configured in the Communications Utility dialog box. Click the Connect button to establish communications.
3. When the connection is made, the status information at the bottom of the screen will change to Connected.

TCP/IP Ethernet Connection

The configuration of a TCP/IP Ethernet connection is not associated with a particular folder and becomes part of your setup in VersaPro.

If a TCP/IP Ethernet configuration has never been defined for a device, or your PLC Ethernet Interface has not been configured, follow the instructions in “Configuring Your PLC and PLC Hardware.”

Configuring Your PC and PLC Hardware

Before connecting via TCP/IP Ethernet, you must set the IP address in your PLC Ethernet Interface. Perform these steps to configure the PLC IP address:

1. From Hardware Configuration, add an Ethernet module or CPU364 to the Series 90-30 rack. .
2. Set the IP Address for the module. Store the hardware configuration to the PLC CPU.

Once you have configured the IP address for the PLC CPU, you need to change the settings for the PC port. Follow these steps to modify port configuration for the PC.

1. Connect your PLC and PC to the Ethernet network.
2. From the Tools menu, choose Communication Setup. (If a password has been defined for the CCU, the Password dialog box will appear. Enter your password and press OK to continue.) The main screen of the CCU will appear.
3. To add a new device, click the New button. The Add New Device dialog box will appear.

Add New Device

Device Name

Selected Device Parameter Settings

Device Model

Default Port

Associated Modem

Associated Device

Device Address

SNP ID

IP Address . . .

Enter 1 or more addresses

OK
Cancel
Help

4. Set the Default Port to ENET and enter an IP Address that matches the IP Address configured for the Ethernet Interface. Click OK to add the device.
5. To customize global timeouts, click the Ports tab, select ENET, and Click Edit. Click Advanced to access global timeouts.

Note: Changes made to Modem Properties through CCU are not saved in the operating system modem settings. To retain these changes, you must edit the Modem Properties in the Windows Control Panel (select Control Panel, then Settings).

Connecting to the PLC

To connect to the PLC:

1. Select the PLC menu and choose Connect (or click the Connect button  on the PLC toolbar). The Connect dialog box will appear. Select the Device Name and Port (ENET) for Ethernet communication. Click the Connect button to establish communications.

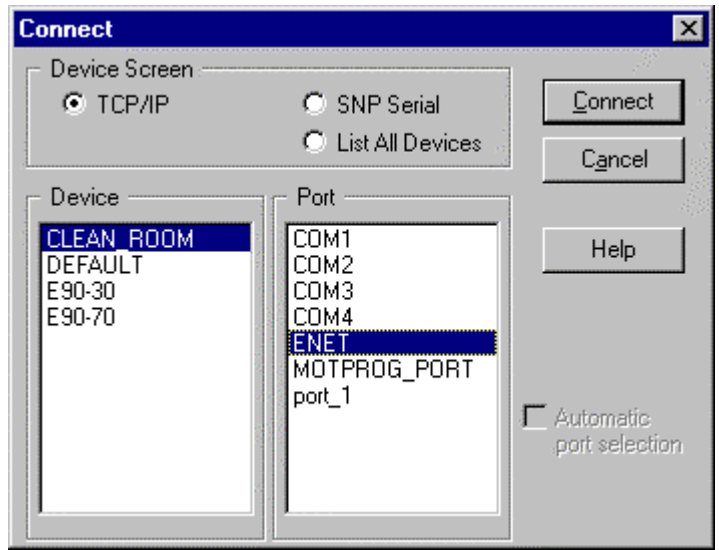

2. When the connection is made, the status information at the bottom of the screen will change to Connected.

Guidelines for Communications Configuration

Many communication issues can be resolved by properly setting the communications timing parameters which may have been altered from previous programmer sessions on the same PC.

The CCU allows you to view and change your settings for the PLCs that you connect to (over Ethernet or serial line). This information provides guidelines on how to configure your communications parameters properly.

Opening the CCU

From VersaPro you can select Tools -> Communications Setup to invoke the CCU application.

From a command line (within an MS-DOS box or from Start -> Run) you may enter GEFCCU32.EXE. This application is installed in the Windows root directory (usually C:\Windows for Windows 95 or Windows 98, and usually C:\WinNT for Windows NT). Since this location is always in your path, you do not need to specify the path when invoking the CCU.

Password

If a password has been defined for the CCU, you will be presented with a dialog box asking for a password. If you only want to look at your communications parameters (not make changes), click the View Only button to view the parameters in Read-Only mode. To change the password, click the Change Password button on the Password dialog box.

To define or change a password for the CCU, go to the File menu and choose Password.

Serial Parameter Settings

If you have used Control software version 1.00 and earlier, your communications configuration may contain invalid settings for some of the SNP timers (SNP is the GE Fanuc proprietary protocol used to communicate to PLCs over a serial line). VersaPro can inherit these settings since it uses the same communications driver. If you encounter communications difficulties, it is recommended that you check your settings in the CCU on the Port tab for each serial COM port and use the following values:

1. Select the Display Advanced Parameters checkbox
2. If you need to make changes, click the Edit button.
3. Set Request Timeout to 20000 or higher (units are in milliseconds, highest valid value is 63000).

4. Set SNP_T3 parameter to a value at least 250 greater than Request Timeout. For example, if your Request Timeout parameter is 20000, set SNP_T3 to 20250 or more.
5. Set SNP_T3P parameter to a value at least 250 greater than the SNP_T3 parameter. For example, if your SNP_T3 parameter is 20250, set your SNP_T3P parameter to 20500 or more.
6. Set SNP_T3PP parameter to a value at least 250 greater than the SNP_T3P parameter. For example, if your SNP_T3P parameter is 20500, set your SNP_T3PP parameter to 20750 or more.
7. To save your changes, click OK on both the Edit dialog box and on the main CCU screen.

Modem Issues

1. When editing modem parameters in the CCU, any settings made in the setup that the Configure Line button brings up are not saved. For the modem settings to be retained, they need to be entered through the Windows operating system. From the Windows Start menu, select Settings, Control Panel, Modems.
2. When setting up VersaPro to communicate with the PLC via modem, you should ensure that the settings in the PLC match those of the modem. For example, for typical modem applications the PLC should be set up for 19200 baud, no parity, 1 stop bit, and a modem turn around time of 1 using the hardware configuration package in VersaPro and then storing this configuration to the PLC. Next, the programmer's PC port must be set up through the Windows operating system by selecting Start, Settings, Control Panel and selecting the Modems icon. The Modems Properties dialog box will appear. The Modem Properties should be set to match the PLC's configuration for number of bits, parity and stop bits. The Advanced Connection Settings should be set to enable Use Flow Control and Hardware (RTS/CTS).
3. From VersaPro, select Tools, Communications Setup to invoke the CCU application. Select Ports, Edit to set the modem turnaround time.

Transferring Folders

After you have established a connection to the PLC, you can transfer Folders between your computer and the PLC. This section covers the following:

- Storing a folder from your PC to the PLC
- Loading a folder from the PLC to the PC
- Verifying that a folder matches the one currently running in the PLC
- Clearing items in the PLC
- Performing read/write operations on PLC flash memory

Storing a Folder to the PLC

You can store hardware configuration, logic or stored/overridden values to the PLC.

In most cases, before storing to the PLC you will need to place the PLC in Stop mode. You can perform a Run mode store only when you are storing certain program changes and the folder nickname matches the PLC nickname.

To place the PLC in Stop mode, click the Stop toolbar button , or go to the PLC menu and choose Stop PLC.

To store the current Folder from your computer to the connected PLC, follow these steps:

1. Confirm that you are connected the PLC. (The VersaPro status bar should indicate “Connected.” If the status bar is not visible, press Ctrl + 0.)
2. Click the Store Button  (or select the PLC menu and choose Store). The Store Folder to PLC dialog box will appear.

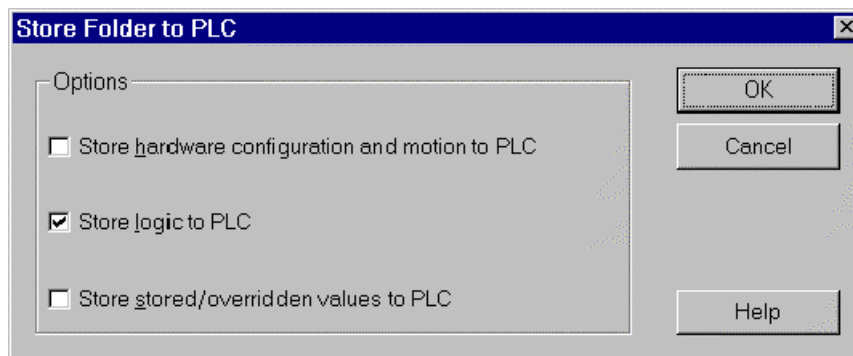

3. Select the folder components you want to store to the PLC: hardware configuration and motion, logic and stored/overridden values. (Motion programs for the Motion Mate DSM314 module are stored as part of hardware configuration.)
4. VersaPro will store the selected components to the PLC. If the store is successful, a message box will appear. The Information Window will provide additional details about the store operation.

CPU Model Checking

When a configuration is Stored, all VersaMax (modular and micro) models reject configuration for a different model.

Version 8.00 and later 350 and above 90-30 CPUs **do not** check the CPU model type when a configuration is stored (they will accept configuration for a different model). Versions earlier than 8.00 **do** have this check (they will reject configuration for a different model).

Word for Word Changes in LD

Word for word changes may be performed on Series 90-30, Series 90 Micro and VersaMax modular PLCs. (VersaMax Nano/Micro PLCs do not support word for word changes.)

Changes to the program that do not modify the size of the program are considered word-for-word changes. Examples include changing the type of contact or coil, or changing a reference address used for an existing function block.

VersaPro Goes Unequal After Check All or Verify

If the following conditions exist when making a Word for Word reference address change:

- The reference is the highest reference used in the program
- The address is changed to a lower value (for example from 500 to 499)
- The reference is only used in one location in the program

VersaPro will go unequal with the PLC after a Check All or a Verify because VersaPro does not update the PLC to the new highest reference used in order to minimize the time to make a Word for Word change. To gain equality, you must store the program to the PLC.

Loading a folder to Your Computer

You can load hardware configuration, logic or stored/overridden values from the PLC to your PC.

To load a folder from the PLC to your computer, follow these steps:

1. Confirm that you are connected to the PLC. (The VersaPro status bar should indicate “Connected.” If the status bar is not visible, press Ctrl + 0.)
2. Click the Load button  (or select the PLC menu and choose Load). The Load Folder from PLC dialog box will appear:

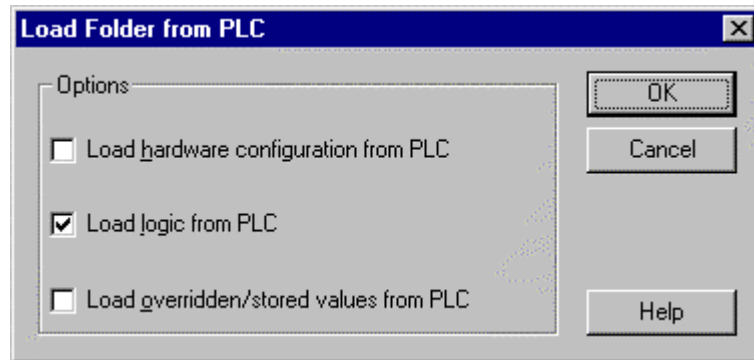

3. Select the components that you want to load. Choose from hardware configuration and motion, logic and stored/overridden values.
4. To begin the load procedure, click the Load button.
5. The selected information will be loaded from the PLC. The Information Window will display the results of the load operation. If the load is successful, a message box will display "Load from PLC Completed."

Note: You cannot load Ethernet Global Data or Name Resolution from a CPU364. When you initiate the Load configuration process, the confirmation dialog box presents the option of backing up the EGD and Name Resolution configuration. To restore these configuration components to your folder, go to the HWC File menu and select Restore EGD and Name Resolution. A browser window will open to enable you to navigate to the backup file.

Clearing the PLC

You can clear Hardware Configuration, Logic, stored/overridden values and PLC and I/O Fault Tables in the PLC.

To clear selected program items from the PLC, follow these steps:

1. Confirm that you are connected to the PLC. (The VersaPro status bar should indicate "Connected." If the status bar is not visible, press Ctrl + 0.)
2. Select the PLC menu and choose Clear. The Clear PLC dialog box will appear.

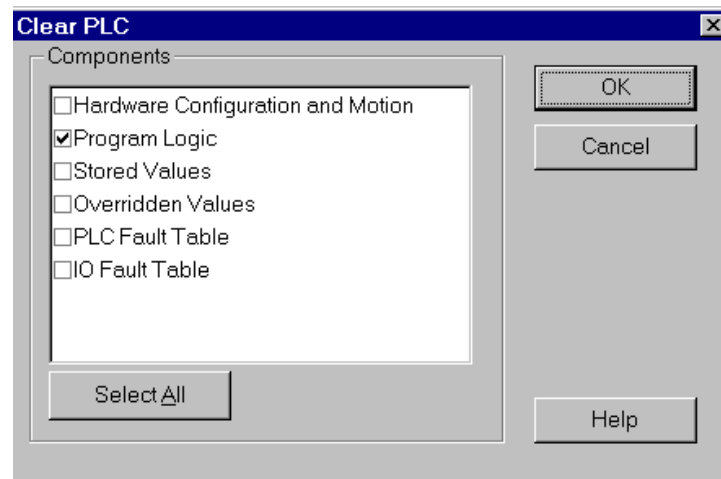

3. Select the items you want to clear in the PLC. Components that have a check mark next to them will be cleared. You can select and deselect individual components by clicking them.
4. To clear the items, click the OK button.
5. When the clear operation is complete, a message box will display "Clear Completed Successfully".

Verifying Folder Data

To verify that the Folder matches what is currently running in the PLC, follow the steps below. You can verify hardware configuration, logic or overridden/stored values with the PLC.

1. Confirm that you are connected to the PLC. (The VersaPro status bar should indicate “Connected.” If the status bar is not visible, press Ctrl + 0.)

2. From the PLC menu, choose Verify, or click the Verify with PLC button. 

3. The Verify Folder with PLC dialog box will appear.

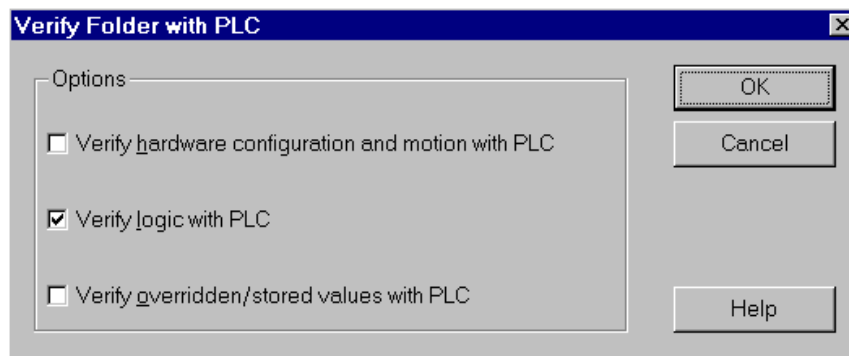

4. Components that have a check mark next to them will be verified. You can select and deselect individual components by clicking them.
5. To begin the verify procedure, click the OK button.
6. A message box will confirm that the verify operation is complete. The Information Window will contain details about the Verify operation.

Reading/Writing/Verifying Flash Memory

Certain CPU models support a flash memory option that allows you to store Folder data to the flash memory device located on the PLC.

To perform read, write, or verify operations on the PLC's Flash memory, follow these steps:

1. Connect to the PLC.
2. Select the PLC menu and choose Flash/EEPROM. The Read/Write/Verify Flash Memory dialog box will appear.

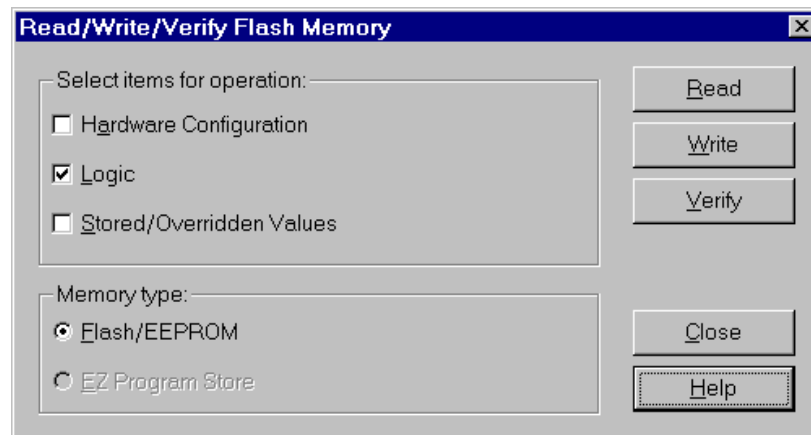

3. Select the folder components you want for the flash operation. You can select individual components by clicking on them.
4. Under Memory Type, select Flash/EEPROM.
5. Select the flash operation by clicking the appropriate button :
 - To **read** from Flash memory to the CPU, click the Read button.
 - To **write** from the CPU to Flash memory, click the Write button.
 - To **verify** that the program data in Flash memory matches that in the CPU, click the Verify button.
6. When the operation is complete, a message box will indicated success or error.

Reading/Writing/Verifying the EZ Program Store Device

The VersaMax EZ Program Store device stores configuration and logic and provides the ability to update configuration and logic in a PLC without the need for a programmer. An end user can update a PLC by connecting the EZ Program Store device to the RS-485 port on the PLC and pressing the momentary-contact switch on the device (PLC must not be scanning I/O). The user can specify whether the data is written only to the PLC's RAM or also to flash memory.

To perform read, write, or verify operations on the EZ Program Store device, follow these steps:

1. Connect to the PLC.
2. Select the PLC menu and choose Flash/EEPROM. The Read/Write/Verify Flash Memory dialog box will appear.

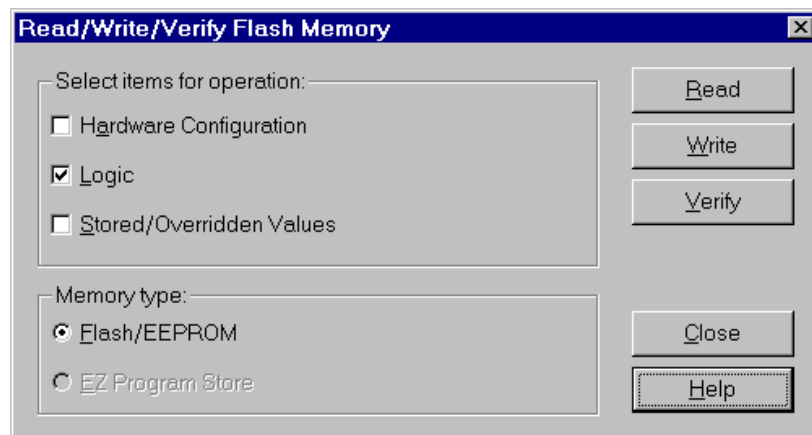

3. Select the folder components you want for the flash operation. You can select individual components by clicking on them.
4. Under Memory Type, select EZ Program Store.
5. Select the flash operation by clicking the appropriate button :
 - To **read** from the EZ Program Store device to the CPU, click the Read button.
 - To **write** from the CPU to the EZ Program Store device, click the Write button.
 - To **verify** that the program data in the EZ Program Store device matches that in the CPU, click the Verify button.
6. When the operation is complete, a message box will indicated success or error.

Viewing PLC Status Information

Once VersaPro is connected with the PLC, you can view PLC status information through the status line at the bottom of the window and through the Status Window dialog box.

When you connect to a PLC, the status line at the bottom of the folder window provides a summary display of status information.

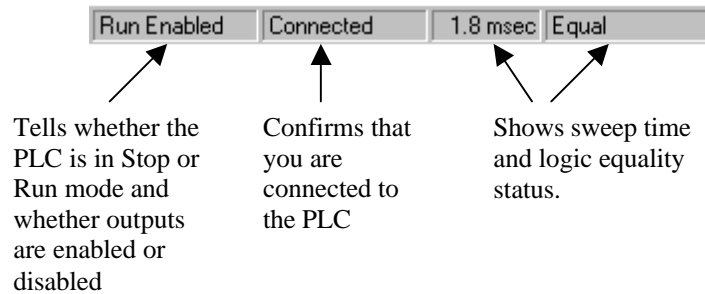

More detailed information is available through the status information dialog box. To view this information select the PLC menu and choose Status Info, or press F4.

The tabs of the Target Communications Window contain the following information:

- **Memory:** Supplies CPU device information, the currently stored program's name, and CPU memory usage
- **Date:** Allows you to view, change, or synchronize date and time
- **Reference:** Displays sizes for all reference tables in the PLC CPU as well as the status of all point fault references
- **Protection:** Displays access level and OEM protection status. Allows you to set access passwords and OEM key.
- **Sweep:** Displays sweep modes and times. When VersaPro is connected, you can set the Sweep Mode and Constant Sweep Time while the PLC is in RUN mode. This change will only affect the PLC until it is transitioned to STOP. When the PLC is returned to RUN mode, the default sweep mode takes effect.

Note: Settings for this tab are stored in the PLC, not in the program folder.

Viewing and Changing Date and Time

To view the current PLC time and date, select the Date tab.

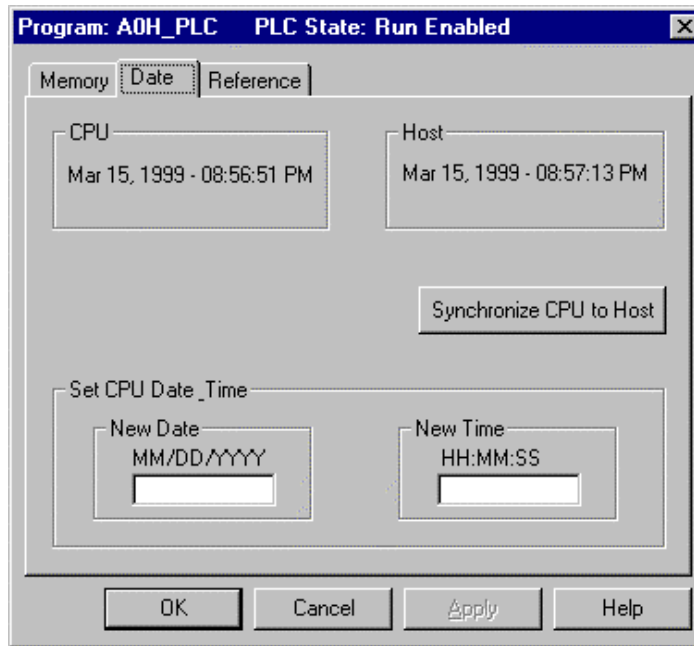

If the CPU's date and time do not match the host computer's, you can synchronize to the CPU clock, or set the CPU date and time.

- **Synchronize CPU to Host:** Click the Synchronize CPU to Host button.
- **Set CPU Date & Time:** Type the month, day, and year (optional) in the New Date field and type the time in hours, minutes, and seconds (optional) in the New Time field. Click the Apply button to accept the changes.

Placing the PLC in Run or Stop Mode

You can manually set the PLC for Run or Stop mode. In Run mode, you can choose to have Outputs enabled or disabled. In Stop mode, you can choose to enable or disable the I/O Scan.

To Place the PLC in Run Mode

1. Confirm that you are connected to the PLC.
2. Click the Run PLC button  (or choose Run from the PLC menu).

To Place the PLC in Stop Mode

1. Confirm that you are connected to the PLC.
2. Click the Stop button  (or choose Stop from the PLC menu).
3. In the Stop Execution dialog box, choose to enable or disable outputs then click the OK button.

Monitoring Logic Execution

VersaPro allows you to view the value or state of an element or operand from the Reference View Table, the Variable View Table, the Ladder Editor, or the Instruction List Editor during logic execution. This can provide you with an opportunity to test the execution of logic, to trigger an event within an executing folder, or to remove an element from logic execution. You can also monitor multiple blocks simultaneously. In order to monitor values online, the logic must be running on the PLC, and VersaPro must be logically connected to the PLC.

Turning Monitoring On and Off

1. Connect to the PLC whose executing logic you wish to monitor.
2. Make sure that the logic in the current folder is equal to that on the PLC.
3. Choose Monitor from the View menu.
4. From the submenu that appears, choose Active Window or All to determine whether elements in only the active window, or all windows, should be updated in real-time.

If you choose Active Window, the active window is updated with data from logic execution.

If you choose All, all active windows are updated with data from logic execution.

- IL, LD, VVT, and RVT are the only active windows that can be monitored.
 - A single active window updates at roughly 10 times a second over a TCP/IP connection.
 - When “All” is selected and more than one window is open, the active window always updates more often than the others. However, each additional open window slows this active window’s updating speed by roughly 1 time per second.
 - Once monitoring has been turned on, it remains on until specifically turned off.
5. To turn monitoring off, choose Monitoring from the View menu.
 6. From the submenu that appears, choose Off.

Note: In order to view real time updates, logic needs to be executing. If you stop executing logic, the latest values remain displaying until monitoring is turned off.

Changing the Display Format of Monitored Logic

1. Connect to the PLC whose executing logic you wish to monitor.
2. Make sure that the logic in the current folder is equal to that on the PLC.
3. Select one variable in the IL or LD Editor.
4. Choose Display Format from the Context-Sensitive or View menu.
5. From the submenu that appears, choose the format in which you wish data to display.
You can choose:

- Octal
- Binary
- Hex
- Real (Only available for the Real data type)
- Scientific Notation (Only available for the Real data type)
- Signed Decimal
- Unsigned Decimal

The display format you select is applied to the selected variables.

Update in progress or unavailable - Press F1 for Help

The "* Update in progress or unavailable – Press F1 for Help *" message is placed on the window title bar while VersaPro is waiting for real time data from the PLC. This message may appear on the Reference View Table, Logic, and Variable View Table windows. This message will appear momentarily under normal operation while real time updates (RTU) are active.

If this message remains on the window title bar for an extended amount of time, it is an indication that you have more windows open for RTU than can be supported by the PLC. In this situation, you should place VersaPro in "Monitor Active" mode using the View menu or tool bar; or reduce the number of windows open for RTU. The following table lists maximum number of open windows that can be monitored for each PLC model.

Maximum Number of Windows and Applications Supported

Target	Windows	Applications*
VersaMax Nano	2	2
VersaMax Micro	2	4
VersaMax modular	16	N/A
Series 90-30 (CPU350-364)	16	N/A
Series 90-30 (CPU311-341)	32	N/A
Series 90 Micro	16	N/A

* Example: VersaPro and the Fault Table count as two applications.

Searching for Overrides

When the VersaPro folder is connected to a PLC, you can search the PLC logic for variables that have overrides. To use this feature, select Search for Overrides from the PLC menu. Variables that are overridden will be listed in the Information Window.

Chapter 11

Working with Fault Tables

The PLC and I/O Fault Tables display fault information logged by the CPU or modules in the PLC. This information is used to determine if there are problems with the PLC hardware or software running in the PLC CPU.

You can view, sort, print and clear faults with the Fault system.

Note: The Fault Table system is a separate application from VersaPro with its own menu bar and toolbar. The Fault Table when minimized is reduced to a button on the Windows taskbar and does not appear in the Equipment Workbench window.

Chapter Contents

- How to view PLC and I/O Fault Tables
- How to obtain details about individual faults
- Sorting faults
- Saving fault information
- Clearing the Fault Table

Working with the PLC and I/O Fault Tables

To view the PLC and I/O Fault Tables, your PC must be connected to and online with the PLC. You can connect to the PLC before opening the Fault Tables. If VersaPro is not connected to a PLC, and you open the Fault Table window, then click the PLC or IO button, the Connect dialog box will appear. (For details, refer to “Connecting to a PLC” in chapter 10.)

Viewing the PLC and I/O Fault Tables

To view the Fault Table from VersaPro, go to the Tools menu, and choose Fault Table. If you are in the PLC Fault Table, click the IO toolbar button to access the I/O Fault Table:

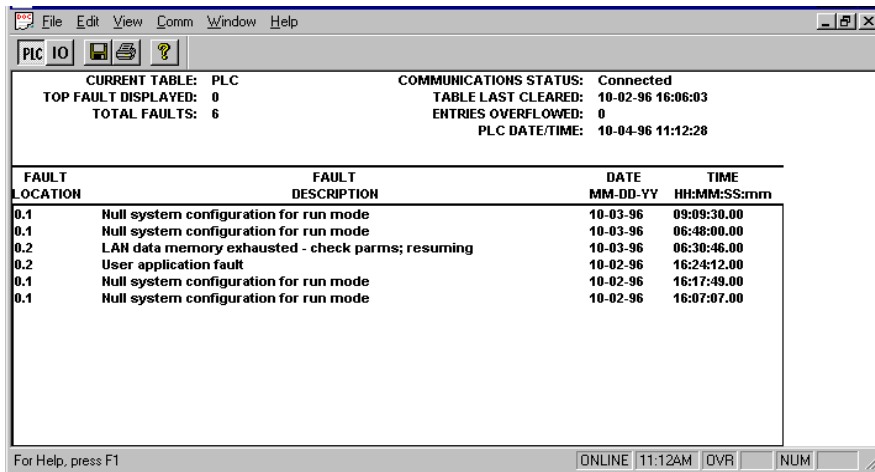

The screenshot shows the VersaPro Fault Table window. The window title is 'VersaPro' and it has a menu bar with 'File', 'Edit', 'View', 'Comm', 'Window', and 'Help'. Below the menu bar is a toolbar with buttons for 'PLC', 'IO', a printer icon, and a help icon. The main area of the window displays the following information:

CURRENT TABLE: PLC
TOP FAULT DISPLAYED: 0
TOTAL FAULTS: 6

COMMUNICATIONS STATUS: Connected
TABLE LAST CLEARED: 10-02-96 16:06:03
ENTRIES OVERFLOWED: 0
PLC DATE/TIME: 10-04-96 11:12:28

FAULT LOCATION	FAULT DESCRIPTION	DATE MM-DD-YY	TIME HH:MM:SS:mm
0.1	Null system configuration for run mode	10-03-96	09:09:30.00
0.1	Null system configuration for run mode	10-03-96	06:48:00.00
0.2	LAN data memory exhausted - check parms; resuming	10-03-96	06:30:46.00
0.2	User application fault	10-02-96	16:24:12.00
0.1	Null system configuration for run mode	10-02-96	16:17:49.00
0.1	Null system configuration for run mode	10-02-96	16:07:07.00

At the bottom of the window, there is a status bar with the text 'For Help, press F1' on the left and 'ONLINE 11:12AM [DVR] NUM' on the right.

To view the I/O Fault Table from VersaPro, click the IO toolbar button:

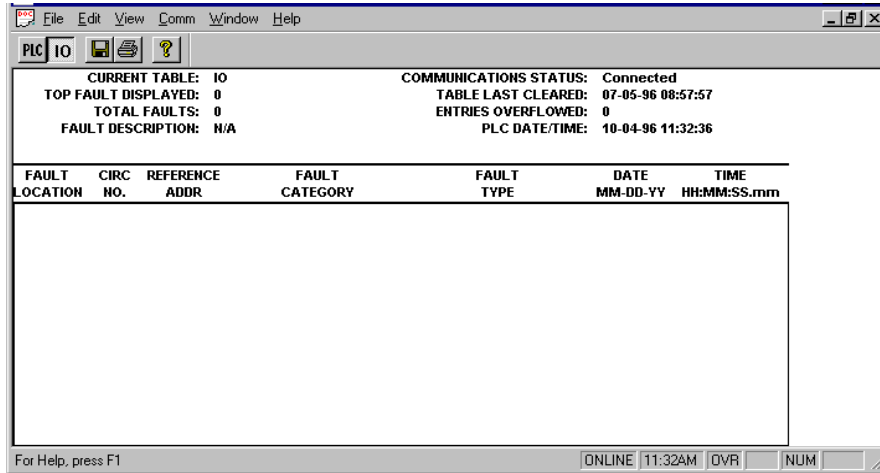

Viewing Fault Details

The fault table provides a summary description of each fault. Additional information describing the fault can be accessed in one of the following ways:

- To obtain additional information for a specific fault, double-click the fault. The Fault Detail dialog box will appear.

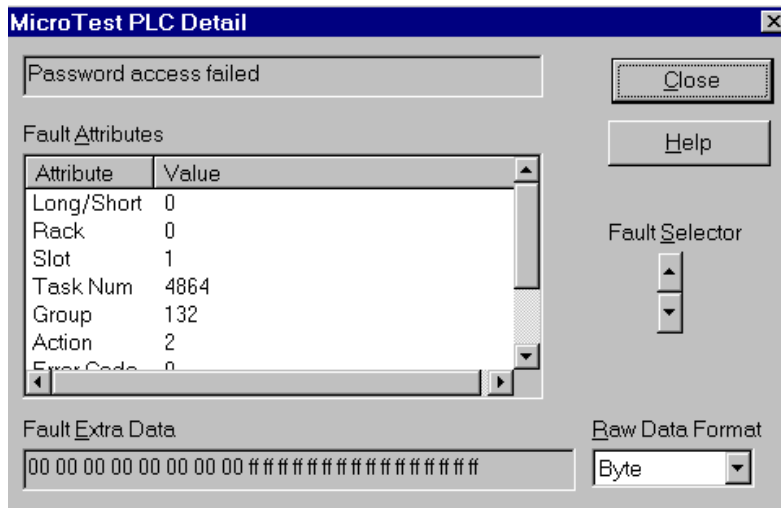

- To list all faults and expanded fault data, select the File menu and choose Save (or Save As). Once you have saved this information, you can then use a text editor to view or print the text file created by the Save operation.

Sorting Faults

Faults are displayed in the order they are logged (based on date and time). However, you can select for faults to be ordered by fault location or grouped by fault description.

To change the order of display, select the View menu, choose Sort and select the key field for the sorted display.

For the PLC Fault Table, the sorting choices are as follows:

- Location
- Description
- Date/Time
- For the I/O Fault Table, the sorting choices are as follows:
 - Location
 - Circuit Number
 - Reference Address
 - Category
 - Type
 - Date/Time

Note: To restore the list to the original dated order, select the View menu and choose Sort Ascending.

Saving Fault Information

You can save fault information to a text file to help you document or troubleshoot a problem. When you save to a file, both the fault table entry and the fault details are saved to file.

Perform these steps to save the fault data:

1. Select the PLC or I/O Fault Table.
2. Select the File menu and choose Save or click the Save button  within the Fault Table window.
3. In the Save As dialog box type the file name for the fault data. (If you previously saved fault information, the new data will be saved to the same file name.)

Clearing the Fault Table

You can clear the entire fault table by pressing F9 or selecting Clear Table from the Edit menu. Clearing faults also clears latched fault indications in all connected logged-in Genius blocks.

If you select Clear Table to clear the fault table, the fault bit in the PLC is reset, and you can put the PLC back into run mode. If you select Clear Entry, the fault bit is NOT reset, and you cannot place the PLC in run mode.

Caution

Clearing the fault table removes the faults. However, it does not fix the underlying problem that generated the fault. Clearing the fault table will allow the PLC to be put in Run mode, even though the fault condition may still exist. If the condition that caused the fault still exists, the fault may be reported again after storing the configuration, cycling power to the PLC, or during a Stop-to-Run transition.

Note: Clearing the fault table does clear fault conditions in the block at the same time the I/O fault table is cleared. Unlike Genius circuit faults, an I/O fault is not logged if it persists after the fault table is cleared. After clearing a fault table, it is possible to place the PLC in RUN mode with an active fault condition that is configured to be fatal. To avoid this condition, always clear the fault tables before storing the program and configuration to the PLC.

Opening Other Fault Tables

It is possible to view fault tables in other PLCs, if the port/device assignment has been established using the Communications Setup option found in the Comm menu.

Perform these steps to open other fault tables:

1. From the File menu, select New I/O Table or New PLC Table. The Connect dialog box will appear.
2. Select the Device Name that matches the PLC containing the fault table you want to open.
3. Select the Port that matches the communication link to the PLC.
4. Click the OK button.

Changing Fonts

You can change the font for the Fault Tables by selecting the Edit menu and choosing Set Font. The Font dialog box will appear allowing you to change the font type, style, and size.

Note: The font changes will affect only the fault tables, not the other areas of VersaPro.

Printing Fault Tables







To print the active Fault Table, select the File menu and choose Print or click the Print button on the toolbar.

This appendix shows the menu bars and toolbars used in VersaPro programming software and the Stand Alone Hardware Configuration tool.







VersaPro Menus

File Menu









The file menu includes standard file and print operations for VersaPro components.

Option	Button	Action
New Block (Ctrl + B)		Creates a new block.
New Motion		Creates a new Local Logic, Motion, or Cam program.
New Reference View Table		Creates a New Reference View Table
New Variable View Table		Creates a new Variable View Table
Save (Ctrl + S)		Saves the selected item.
Save All (Shift + Ctrl +A)		Saves the entire folder.
Close (Ctrl + F4)		Closes the selected window.
New Folder (Ctrl + N)		Creates a new folder, or imports an existing folder.
Open Folder (Ctrl + O)		Opens an existing folder.
Close Folder		Closes the open folder.
Print		Prints the selected item.
Print Report		Allows you to define which components and blocks should be included in a report, then print the report.
Page Setup		Allows you to specify page parameters.
<MRU list>		Lets you open a recently used folder from a list of Most Recently Used folders (the MRU list) that appears here on the menu.
Exit (Alt + F4)		Closes VersaPro software.

Edit Menu

Option	Button	Action
Undo <action> (Ctrl + Z)		Reverses the previous action. The previous action (for example, Drop or Delete) appears instead of "<action>".
Redo <action> (Ctrl + Y)		Reverses the previous undo action. The previous action (for example, Drop or Delete) appears instead of "<action>".
Cut (Ctrl + X)		Removes the selected item and places it on the Clipboard.
Copy (Ctrl + C)		Copies the selected item to the Clipboard.
Copy As		Copies the selected element(s) as either a bitmap image or as text to the Clipboard.
Paste (Ctrl + V)		Pastes the Clipboard contents to the selected area.
Delete (Del)		Deletes selected item(s).
Select All (Ctrl + A)		Selects all items
Find/Replace (Ctrl + F3)		Allows you to Find and Replace a variable Name or Address, a Call to a Subroutine, or a Jump/Label or MCR/END_MCR pair in logic
Find Next (F3)		Finds next item of defined search criteria.
Find In Blocks (Ctrl + F10)		Finds a particular global or system variable by Name or Address, or a Call to a Subroutine in blocks.
Go to (Ctrl + G)		Allows you to go to a row in IL logic or a rung in LD logic.
Go to Variable (Ctrl + F11)		Allows you to go to a variable in the VDT.
Go to Next Coil (Alt + F3)		In the LD editor, moves the cursor to the next coil with the same name as the selected reference
Properties (Alt + Enter)		Allows you to add a description to the current block, to add a description to the current folder, or to set the properties of temporary variables or conversion variables.



View Menu

Option	Button	Action
Toolbars (Ctrl + T)		Shows or hides toolbars.
Function Toolbars		Allows you to expand or compact function toolbars
Status Bar (Alt + O)		Shows or hides the Status bar.
Folder Browser (Alt + 1)		Opens or closes the Folder Browser window.
Information Window (Alt + 2)		Opens or closes the Information window.
Variable Declaration Table (Alt + 3)		Opens or closes the Variable Declaration Table Window
Hardware Configuration (Alt + F4)		Opens the Hardware Configuration window.
MAIN block (Alt + F5)		Opens the _MAIN block.
Local Logic Variable Table (Alt + 6)		Opens or closes the Local Logic Variable Table, if the folder contains a Local Logic program.
Sort		Allows you to sort specific columns of the VDT in ascending or descending order.
Monitor		Allows you to disable or enable real-time logic execution on the PLC in all windows or in the active window.
Display Format		Allows you to change the display format of monitored logic.
Format View Table		Allows you to determine how data is displayed in the selected Variable View Table row, Reference View Table row, or entire Reference View Table.
Zoom In (Ctrl + "=")		Makes view larger.
Zoom Out (Ctrl + "-")		Makes view smaller.













Insert Menu

Option	Button	Action
Object		Allows you to insert an object into the Folder Browser.
Block		Allows you to insert a block into the Folder Browser.
Row (Ins)		Inserts a row above the selected row in the IL editor, LD editor, VDT, or a View Table.
Comment		Allows you to insert a comment.

Folder Menu

Option	Button	Action
Check Selected Block(s) (Ctrl + F7)		Checks the selected block(s) for syntactic correctness. If no block is selected, this menu option reads "Check Block_Main" and selecting it results in checking the _Main block for syntactic correctness.
Check All (F7)		Checks all blocks for syntactic correctness.
Lock/Unlock		Locks or unlocks the open folder.
Backup (F8)		Backs up a folder.
Restore (Ctrl + F8)		Restores a folder.
Restore Motion Blocks		Allows you to restore individual Motion blocks that have been backed up during a Load operation.
Find Unused Variables		Finds unused variables. The unused variables are listed in the Information window by Name, Scope, and Address.
Compact		Reduces the size of the folder by removing edit history information from the VDT.

PLC Menu

Option	Button	Action
Connect (F9)		Connects to the PLC
Disconnect (Ctrl + F9)		Disconnects from the PLC
Store (Alt + F2)		Stores the contents of a folder to the PLC
Load (Ctrl + F2)		Loads the contents of a folder from the PLC
Verify (F4)		Verifies the equality of the current folder and the connected PLC.
Clear		Clears the memory of the PLC.
Flash/EEPROM		Allows you to read, write, or verify Flash memory.
Search for Overrides		When VersaPro is connected to a PLC, searches the PLC logic for variable overrides.
Run (F5)		Runs the logic resident in the PLC
Stop (Ctrl + F5)		Stops the logic resident in the PLC
Toggle (F12)		Allows you to toggle a reference.
Override (F11)		Allows you to override a reference.
Write (F10)		Allows you to write a value to the selected reference in the LD editor, IL editor, VVT or RVT..
Tuning Parameters		Allows you to tune PID Instructions.
Status Info (Shift + F4)		Allows you to view the status of the PLC.
Abort! (Ctrl + Break)		Stops a communications action.



Tools Menu

Option	Action
Fault table	Opens a fault table.
Communications Setup	Allows you to define communications parameters
Cam Editor	Opens the Cam Editor, which is used for creating Cam profiles and blocks for Motion programming.
Import Variables	Allows you to import a variable.
Export Variables	Allows you to export a variable.
Convert Block	Allows you to convert logic from one language to another.
View Online Cross Reference	Displays, in the information window, a list of all variables used in the selected block by reference type.
Convert Block	Converts selected block from LD to IL or IL to LD.
Non-Nested to Nested Conversion	Converts non-nested MCR, ENDMCR, JUMP, and LABEL instructions to the nested version.
Options (Ctrl + E)	Allows you to set General (language-related), Display (colors, fonts), Ladder (show fields, cell width), and Autoconnect options.

Window Menu

Option	Action
Cascade (Alt + 6)	Arranges all open block windows so that all title bars are visible and the active window is in front.
Tile Horizontally (Alt + F7)	Resizes and horizontally arranges all open block windows so that all of them are visible.
Tile Vertically (Alt + F8)	Resizes and vertically arranges all open block windows so that all of them are visible.
Arrange Icons (Alt + F9)	Aligns all minimized block windows.
Close All (Alt + F10)	Closes all open block windows.
Next Window (F6)	Moves focus among the active editor window and the dockable windows that are open. (In the editor window, goes to the selected row or cell, which may be out of view.)
Previous Window (Shift + F6)	Moves focus among the active editor window and the dockable windows that are open. (In the editor window, goes to the selected row or cell, which may be out of view.)
[Current Window]	Displays the name of the active window.

Help Menu

Option	Action
Contents and Index	Displays VersaPro Help.
About VersaPro	Displays information about this version of VersaPro.















VersaPro Toolbars

VersaPro has six toolbars: the Standard toolbar, the Ladder toolbar, the View toolbar, the Folder toolbar, the PLC toolbar, and the Function toolbar. You may hide any or all toolbars to provide more space to work. Unavailable toolbar buttons appear in dim gray.

Standard toolbar









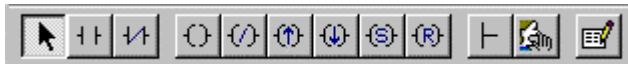





The Standard toolbar is displayed by default, although you can hide it. The Standard toolbar buttons provide common functions, such as opening folders, saving folders and blocks, cutting, copying and pasting, and undo and redo.

Button	Function
	Creates a new folder.
	Creates a new block.
	Opens an existing folder.
	Saves the selected block.
	Saves the entire folder.
	Removes the selected item and places it on the Clipboard.
	Copies the selected item to the Clipboard.
	Pastes the Clipboard contents to the selected area.
	Reverses the previous action.
	Reverses the previous undo action.
	Deletes selected item(s).
	Sends the selected item to a printer.
	Displays context-sensitive help.
	Aborts a communications action.

Ladder toolbar



Use the Ladder toolbar to create ladder logic using "click and drop."











Button	Function
	Selects the normal pointer; disables "click and drop"
	Lets you drop a normally open contact
	Lets you drop a normally closed contact
	Lets you drop a normally open coil
	Lets you drop a normally closed coil
	Lets you drop a positive transition coil
	Lets you drop a negative transition coil
	Lets you drop a set coil
	Lets you drop a reset coil
	Lets you drop a vertical or horizontal wire
	Lets you drop a CALL instruction
	Lets you insert a comment row.

Note: Pressing the Escape key disables drop mode and makes the pointer active again.

View toolbar





Use the View toolbar to show or hide windows, to open the _MAIN block, or to magnify or reduce a window's contents. Buttons not related to the current task are not available.

Button	Function
	Shows or hides the Folder Browser
	Shows or hides the Variable Declaration Table
	Shows or hides the Information Window
	Opens the Hardware Configuration window
	Opens the _MAIN block
	Opens the Local Logic Variable Table
	Monitors all windows.
	Monitors the active window.
	Turns monitoring off.
	Zooms In on (magnifies) the active window's contents
	Zooms Out from (reduces) the active window's contents

Folder toolbar













Use the Folder toolbar to check syntax.

Button	Function
	Checks all blocks for syntactic correctness.
	Checks selected block(s) for syntactic correctness.

PLC toolbar



Use the PLC toolbar to connect to a PLC, and to perform operations involving a connected PLC, like storing and loading, or running and stopping logic.

Button	Function
	Connects to the PLC.
	Disconnects from the PLC.
	Stores this folder to the PLC.
	Loads a folder from the PLC.
	Verifies equality between the current folder and elements present on the PLC.
	Runs the PLC.
	Stops the PLC.
	Toggles a reference.
	Overrides a reference.
	Writes a value to a reference.
	Shows the status of the PLC.

Function toolbar

Use the Function toolbars to select function block types while programming in the LD editor. Function groups are listed in alphabetic order.

The Function toolbars can be configured to display in expanded or compact mode. To change the mode, select the View menu, choose Function Toolbars, then select Expanded or Compact.



HWC Menus

File Menu

The File menu offers the following commands:

Option	Action
New (Ctrl + N)	Creates a new Hardware Configuration Folder.
Open (Ctrl + O)	Opens an existing Hardware Configuration Folder.
Close	Closes an opened Hardware Configuration Folder.
Import Stand-Alone HWC File	Imports an existing HWC Hardware Configuration Folder (.hwcfg) into the current Rack System Edit window.
Import Hardware Configuration Folder	Imports an IOCFG.CFG file (and optional CPUCFG.CFG file), that was produced by either LM90 or CC90, into a designated new HWC Hardware Folder.
Restore EGD and Name Resolution	Restores EGD and Name Resolution configuration from a backup file created during configuration Load.
Save (Ctrl + S)	Saves an opened document using the same file name.
Save As	Saves an opened document to a specified file name.
Convert To	Converts the current Rack System configuration to a default Rack System configuration of the type selected: Series 9030 VersaMax VersaMax Nano/Micro Series 90 Micro (You can only convert a Rack System configuration to a different type of Rack System. If you want to create the same type of Rack configuration as the current one, use Save As.)
Print (Ctrl + P)	Prints all or portions of the current Rack System Hardware Configuration.
Print Preview	Displays all, or portions, of the current Rack System Hardware Configuration on the screen as it would appear when printed.
Print Setup	Selects a printer and printer connection.
Exit	Exits HWC.

Edit Menu

Option	Action
Undo (Ctrl + Z)	Reverse previous Module operation. Up to 16 levels of Undo are supported.
Redo (Ctrl + Y)	Reverses previous Undo operation. Up to 16 levels of Redo are supported
Cut (Ctrl + X)	Deletes the selected Module from the Rack System and moves it to the clipboard.
Delete (Del)	Deletes the currently selected Module from the Rack System and reverts it to a blank slot
Copy (Ctrl + C)	Copies selected Module from the Rack System to the clipboard.
Paste (Ctrl + V)	Pastes the previously cut or copied Module from the clipboard into the selected slot of the Rack System.
Expansion Rack System	Sub-menu of edit operations that are specific to VersaMax Rack Systems.
Expansion Receiver	Sub-menu of edit operations that are specific to VersaMax Expansion Rack Systems.
Rack Operations	Sub-menu of edit operations that are specific to the Rack System.
Module Operations	Sub-menu of edit operations that are specific to the selected Module.

Edit menu, Expansion Rack System Sub-menu

The Expansion Rack System sub-menu of the Edit menu allows you to select the type of VersaMax system. You can switch from one VersaMax system type to another, however resulting changes to the configuration cannot be undone.

Option	Action
None	This is the default VersaMax system, which is created when you select New from the File menu. It includes only the Main VersaMax I/O station (no Expansion).
Local Single Rack	Includes the Main VersaMax I/O station and one Expansion I/O Station (Rack). The Main VersaMax system does not contain a Transmitter. The Expansion I/O Station contains a Non Isolated Receiver and Power Supply Integrated Unit (IC200ERM002).
Multiple Remote Rack	Allows you to configure up to seven Expansion I/O Stations (seven Rack tabs are always shown). The Main VersaMax rack contains a Transmitter (IC200ETM001). Each Expansion I/O Station contains a Power Supply and Receiver Integrated Unit. The Non Isolated Receiver (IC200ERM002), which is configured by default, can be replaced by an Isolated Receiver (IC200ERM001).

Note: The Transmitter module cannot be selected from the module catalog. The only way to add this module to a rack configuration is to choose the appropriate configuration type. Also, you cannot delete a Transmitter module from a rack configuration except by changing the rack configuration type.

Edit menu, Expansion Receiver Sub-menu

The Expansion Receiver sub-menu of the Edit menu allows you to select the receiver for a VersaMax Local Single Rack or Multiple Remote Rack system.

Option	Action
None	Deactivates the Receiver. This is the default selection if no carrier/base is configured. This option is not available if there is at least one carrier/base configured in the expansion rack.
Non-Isolated Receiver Unit	Selects the Non Isolated Receiver and Power Supply Integrated Unit (IC200ERM002). This is the only receiver type allowed for Local Single Rack systems.
Isolated Receiver Unit	Selects the Non Isolated Receiver (IC200ERM002). This option is available only for Multiple Remote Rack systems.

Edit menu, Rack Operations Sub-menu

Option	Action
Change Rack Type	Displays the 90-30 Change Rack Type Dialog. This menu item is not available for VersaMax systems.
Clear Rack	Deletes all modules, excluding the Power Supply and CPU, for the selected Rack.
Configure CPU Parameters	Displays the Module Parameter Dialog, which allows editing of the configuration parameters for the Rack System CPU.
Replace CPU	Displays the Module Selection Dialog, which allows for the selection of a replacement Rack System CPU.
Name Resolution and Routing	Displays the 90-30 Ethernet Adapter Name Resolution Dialog, which allows for the specification of Ethernet Adapter Naming and Routing Tables. This menu item is not available for VersaMax systems.
Ethernet Global Data	Displays the 90-30 Ethernet Global Data Dialog, which allows for the definition of Ethernet Exchange Ids. This menu item is not available for VersaMax systems.
Add Base/Carrier	Displays the VersaMax Add Base/Carrier Dialog, and extends the selected rack with the selected Base/Carrier. This menu item is not available for 90-30 systems.
Delete Base/Carrier	Deletes the currently selected Base/Carrier in a VersaMax rack. This menu item is not available for 90-30 systems.
Insert Base/Carrier	Displays the VersaMax Insert Base/Carrier Dialog, and inserts the selected Base/Carrier in front of the selected slot of the VersaMax rack. This menu item is not available for 90-30 systems.
Replace Base/Carrier	Displays the VersaMax Replace Base/Carrier Dialog, and replaces the selected Base/Carrier in the selected slot of the VersaMax rack. This menu item is not available for 90-30 systems.
Configure Receiver Parameters	Displays the power consumption tab for the VersaMax expansion rack receiver, which has no configurable parameters. This menu item is available only when the receiver unit, located in the first slot of the expansion rack, is selected.



Edit menu, Module Operations Sub-menu

Option	Action
Configure Parameters (Ctrl + E)	Displays the Module Parameter Dialog, which allows for the editing of the configuration parameters for the selected Module.
Add Module	Displays the Module Selection Dialog, which allows for the selection and configuration of a new Module in the selected empty rack slot (or Carrier/Base in a VersaMax modular system).
Replace Module	Displays the Module Selection Dialog, which allows for the selection and configuration of a replacement Module for the selected Module.
Delete Module	Deletes the selected Module from the Rack system.

Parameter Menu

Option	Action
Data Entry Tool (F2)	Opens the Data Entry Tool for a selected, editable parameter.
Reset Parameter	Resets a single parameter to the Start of Edit Session value or to the Factory Original Value
Reset Tab	Resets all the parameters on the tab to the Start of Edit Session value or to the Factory Original value.
Cancel Edit Session	Closes the active parameter edit window without saving changes.
Insert	Inserts a row with default values above the selected row in certain tabs, such as the Profibus Slave Information tab.
Delete	Deletes the selected row in certain tabs such as the Profibus Slave Information tab and adds a default row to the end of the matrix.

View Menu

Option	Action
Toolbar	Shows or hides the toolbar.
Status Bar	Shows or hides the status bar.
Log View	Shows or hides the on-line HWC Log View.
Reference View	Shows or hides the on-line Rack System Reference View
Power Consumption	Shows or hides the Power View window.
Parameter Edit	Displays a sub-menu that allows you to change the Parameter Editor display format. These options are available only when a Parameter Editor window for a module is open.

View Menu, Parameter Edit Sub-menu

Note: These settings are not saved when you close the Parameter Editor. To set the default display mode for the Parameter Editor, go to the Tools menu, choose Options and select the Parameter Edit tab in the Options dialog box.

Option	Action
Singlerow Tab	Displays the Parameter Editor window in a tabbed format. If you resize the window so that it is too narrow to display all the tabs, a scroll bar is provided to access tabs that are not visible.
Multirow Tab	Displays the Parameter Editor window in a tabbed format. If you resize the window so that it is too narrow to display the tabs in a single row, the tabs will be stacked.
Spreadsheet	Displays the Parameter Editor window in a spreadsheet format. Tab headings are displayed in bold, underlined text.
Error Status	Displays the Parameter Editor Error List, which identifies parameter errors and allows you to correct them before closing the window. This option is available only when the current Parameter Editor window contains errors.

Tools Menu

Option	Action
Hardware Configuration Data View	Displays the PLC Configuration Data in a tabbed dialog, allowing for both text and binary formatted presentation of the contained information.
Options	Displays an Options dialog, which allows you to adjust certain application behavior such as Log size and Parameter Editor view.
Communications Setup	Opens the CCU. Allows you to define communications parameters.
Load/Store/Verify	If an NIU is configured in the rack system, allows you to load, store, verify, or clear the hardware configuration.



Window Menu







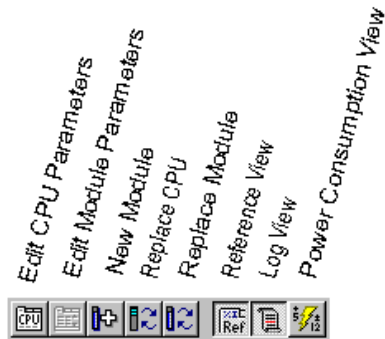

Option	Action
Cascade	Arranges windows in an overlapped fashion.
Tile	Arranges windows in non-overlapped tiles.
Arrange Icons	Arranges icons of closed windows.
Window 1, 2, ...	Goes to specified window.

Help Menu

Option	Action
Contents	Displays a structured Help Table of Contents from which you can get help.
Help Index	Offers you an index to topics on which you can get help.
Module Help	Provides parameter-specific help for the selected Parameter Editor window.
How to Use Help	Enumerates the different types of Help available in HWC and describes how each can be applied to assist you in learning and using the program.
About HWC	Displays the version number of this application.

HWC Toolbar



Button	Function
	Opens Parameter Editor window for CPU.
	Opens Parameter Editor window for selected module.
	Opens the Module Catalog, from which you can select a module to be configured.
	Opens the Module Catalog, from which you can select a CPU to be configured.
	Opens the Module Catalog, from which you can select a module to be configured in place of the selected module.
	Displays or hides the Reference View, which lists references configured for the rack system.
	Displays or hides the Log View, which displays a history of significant events and status relative to your hardware configuration editing activities.
	Displays or hides the Power View, which shows the power consumed by the modules in the system.

Appendix
B

Serial Connections

This appendix describes the serial port, converter, and cables used to connect to Series 90 and VersaMax PLCs for Series 90 Protocol (SNP) as well as the Miniconverter Kit. This information is included for reference and for those users who have applications that require cable lengths different than the factory-supplied cables.

Serial Port and Cables

RS-422 Interface

The Series 90-30, Series 90 Micro, and VersaMax PLC products are compatible with EIA RS-422 specifications. RS-422 drivers and receivers are utilized to accomplish communications between several system components using multiple driver/receiver combinations on a single cable with five twisted pairs. The total cable length cannot exceed 4000 feet.

A multi-drop system of eight drivers and receivers can be configured. The maximum common mode voltage between each additional drop is the RS-422 standard of +7 Volts to -7 Volts. The driver output must be capable of ± 2 V minimum into 100 ohms. The driver output impedance must be at least 120 K ohms in the high impedance state. The receiver input resistance is 12 K ohms or greater. Receiver sensitivity is ± 200 millivolt.

Caution

Care must be taken that common mode voltage specifications are met. Common mode conditions that exceed those specified will result in errors in transmission and/or damage to components.

Cable and Connector Specifications

The cable assembly presents one of the most common causes of communication failure. For best performance construct the cable assemblies according to the recommended connector parts and specifications.

Item	Description
Mating Connectors:	<p>PLC: Serial (RS-422) port with metric hardware Connector: 15-pin male, D-Subminiature Type, Cannon DA15S (solder pot) Hood: AMP 207470-1 connector shell Hardware Kit: AMP 207871-1 Kit includes 2 metric screws and 2 screw clips</p>
	<p>IBM-AT/XT: Serial (RS-232) port with standard RS-232 connector Connector: 9-pin female, D-Subminiature Type, Cannon DE9S (solder pot) with DE110963-31 hood or equivalent (standard RS-232 connector)</p>
	<p>RS-232/RS-485 Converter: one 15-pin male, and one 25-pin male connector 15-pin male connector requires metric hardware (same connector, hood, and hardware as for Series 90 PLC listed above) 25-pin male D-Subminiature Type, Cannon DA25S (solder pot) with DB110963-3 hood or equivalent (standard RS-232 connector)</p>
Cable:	<p>Computer grade, 24 AWG (.22 mm²), minimum with overall shield Catalog Numbers: Belden 9505, Belden 9306, Belden 9832</p> <p>These cables provide acceptable operation for data rates up to 19.2 Kbps as follows: RS-232: 50 feet (15 meters) maximum cable length RS-422/RS-422: 4000 feet (1200 meters) maximum length. Must not exceed the maximum RS-422 Common Mode specification of +7V to -7V. Isolation at the remote end may be used to reduce or eliminate Common Mode voltages.</p> <p>At shorter distances under 50 feet (15 meters), almost any twisted pair or shielded twisted pair cable will work, as long as the wire pairs are connected correctly</p> <p>When using RS-422/RS-422, the twisted pairs should be matched so that both transmit signals make up one twisted pair and both receive signals make up the other twisted pair. If this is ignored, cross-talk resulting from the mismatching will affect the performance of the communications system.</p> <p>When routing communication cables outdoors, transient suppression devices can be used to reduce the possibility of damage due to lightning or static discharge.</p> <p><i>Care should be exercised that all connected devices are grounded to a common point. Failure to do so could result in damage to the equipment.</i></p>

PLC Serial Port

The Series 90 and VersaMax PLC serial port is compatible with RS-422. An RS-232 to RS-422 converter is required to interface to systems that provide RS-232 compatible interfaces.

The PLC RS-422 serial port provides the physical connection for SNP communication.

The figure below shows the serial port orientation and connector layout for the PLC port.

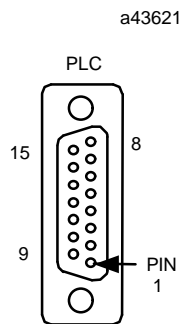

The table below shows the pin numbering and signal assignment:

Pin Number	Signal Name	Description
1	Shield	
2		No Connection
3		No Connection
4	ATCH *	Hand-Held Programmer attach signal
5	+5V *	+5V Power for: HHP and RS-232/485 Converter
6	RTS (A)	Request To Send
7	Signal Ground	Signal Ground, OV
8	CTS (B')	Clear To Send
9	RT *	Terminating Resistor for RD **
10	RD (A')	Receive Data
11	RD (B')	Receive Data
12	SD (A)	Send Data
13	SD (B)	Send Data
14	RTS (B)	Request To Send
15	CTS (A')	Clear To Send

* Signals available at the Connector but are not included in the RS-422 specification.

SD (Send Data) and RD (Receive Data) are the same as TXD and RXD (used in the Series Six PLC).

(A) and (B) are the same as - and +. A and B denote outputs, and A' and B' denote inputs.

IBM-AT/XT Serial Port

The IBM-AT, IBM-XT or compatible computer's RS-232 serial port is a 9-pin D-type male connector as shown in the figure below.

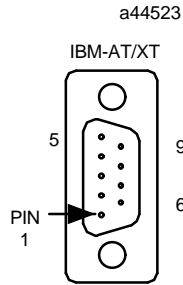

The following table shows the serial port pins-out:

IBM-AT Pin No.	Signal	Description
1	DCD	Data Carrier Detect
2	RD	Receive Data
3	TD	Transmit Data
4	DTR	Data Terminal Ready
5	GND	Signal Ground
6		NC
7	RTS	Request to Send
8	CTS	Clear to Send
9		NC

IBM-XT Pin No.	Signal	Description
1		NC
2	TD	Transmit Data
3	RD	Receive Data
4	RTS	Request to Send
5	CTS	Clear to Send
6		NC
7	GND	Signal Ground
8	DCD	Data Carrier Detect
9	DTR	Data Terminal Ready

NC = Not Connected

RS-232/RS-485 Converter

The RS-232/RS-485 Converter (IC690ACC900) can be used to convert from RS-232 to RS-422/RS-485 communications. The converter has one 15-pin female D-type port, and one 25-pin female D-type port.

This converter unit can be purchased from GE Fanuc Automation. Please contact any GE Fanuc Automation sales office or field service representative.

Serial Cable Diagrams

This section shows two serial port connections for Series 90 and VersaMax PLCs. Cabling may vary, depending on the devices and converter used in your application.

In the point-to-point configuration only two devices can be connected to the same communication line. The communication line can be directly connected using RS-232 (50 feet, 15 meters maximum) or RS-485 (4000 feet, 1200 meters maximum). Modems can be used for longer distances.

RS-232 Point-to-Point Connection

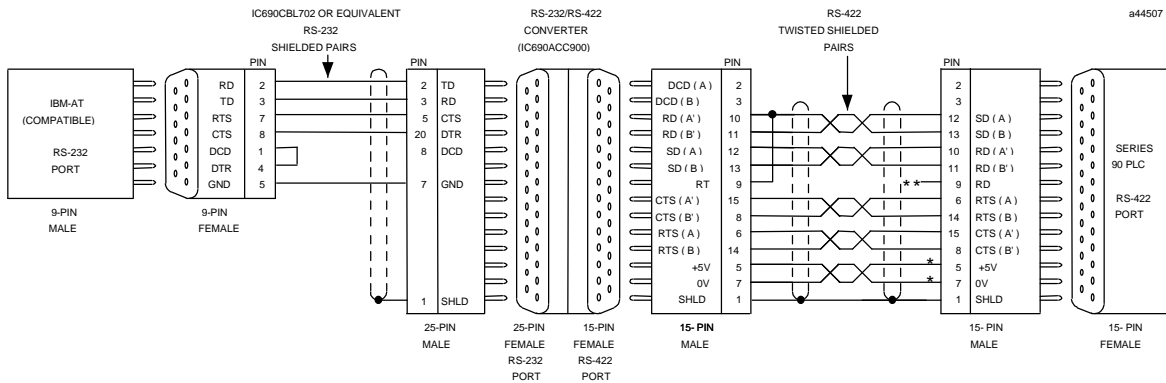

*Power source for point-to-point connection 10 feet (3 meters) only. Converter power source beyond 10 feet (3 meters) and for multidrop connection must be external source.

** Termination resistance for the receive data (RD) signal needs to be connected only on units at the end of the lines.

Series 90 PLC products by connecting a jumper between pin 9 and pin 10 inside the 15-pin D-shell with the following exception. For Series 90-70 PLCs, catalog numbers IC697CPU731 and IC697CPU771, the termination for RD at the PLC is implemented by a jumper between pin 9 and pin 11.

Multidrop Connections

In the multidrop configuration, the host device is configured as the master and one or more PLCs are configured as slaves. This method can be used when the maximum distance between the master and any slave does not exceed 4000 feet (1200 meters). This figure assumes good quality cables and a moderately noisy environment. A maximum of 8 slaves can be connected using RS-422 in a *daisy chain* or multidrop configuration. The RS-422 line must include handshaking and use wire type as specified in the “Cable and Connector Specifications” section.

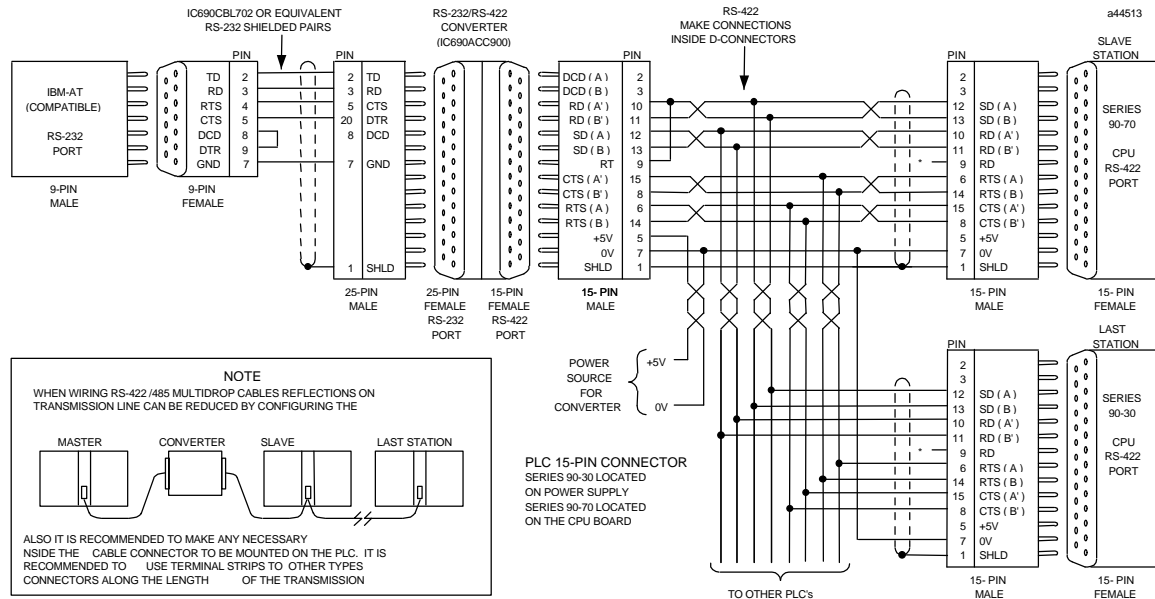

Termination resistance for the receive data (RD) signal needs to be connected only on units at the end of the lines. This termination is made on the Series 90 PLC products by connecting a jumper between pin 9 and pin 10 inside the 15-pin D-shell with the following exception. For Series 90-70 PLCs, catalog numbers IC697CPU731 and IC697CPU771, the termination for RD at the PLC is implemented by a jumper between pin 9 and pin 11.

Ground Potential: multiple units, not connected to the same power source, must have common ground potentials proper operation of this system.

Miniconverter Kit

This section describes the Miniconverter Kit for use with Series 90 and VersaMax PLCs.

Description of Miniconverter

The Miniconverter Kit (IC690ACC901) consists of an RS-422 (SNP) to RS-232 Miniconverter, a 6 foot (2 meter) serial extension cable, and a 9-pin to 25-pin Converter Plug assembly. The 15-pin SNP port connector on the Miniconverter plugs directly into the serial port connector on the Series 90-30 and VersaMax PLCs. The 9-pin RS-232 port connector on the Miniconverter connects to an RS-232 compatible device.

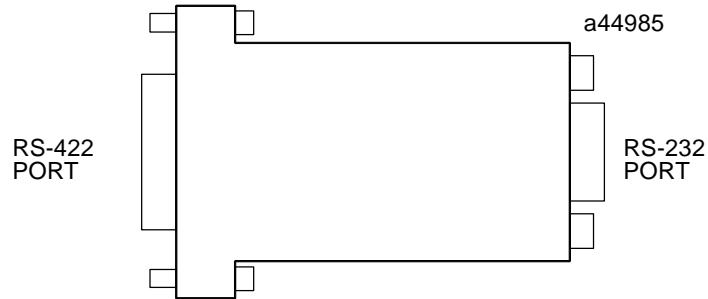

When used with an IBM PC-AT, or compatible computer, one end of the extension cable plugs into the Miniconverter's 9-pin serial port connector, the other end plugs into the 9-pin serial port of the computer. The Converter plug (supplied with kit) is required to convert the 9-pin serial port connector on the Miniconverter to the 25-pin serial port connector on the IBM PC-XT or PS/2 Personal Computer.

Pin Assignments, RS-232 Port

The pinout of the Miniconverter is shown in the following two tables. The first table shows the pinout for the RS-232 port. The direction of signal flow is with respect to the Miniconverter.

Pin	Signal Name	Direction
2	SD - Send Data	Output
3	RD - Receive Data	Input
5	GND - Ground	n/a
7	CTS - Clear To Send	Input
8	RTS - Request To Send	Output

The pinouts were chosen to allow direct connection (using a straight through, or 1 to 1 cable (as provided with kit) to the IBM PC-AT. Most IBM compatible computers equipped with an RS-232 port will provide a pinout compatible with the one shown above.

Pin Assignments, RS-422 Port

The following table shows the pinout for the Miniconverter's RS-422 serial port. The direction of signal flow is also with respect to the Miniconverter.

Pin	Signal Name	Direction
1	SHLD - Shield	n/a
5	+5 VDC - Power	Input
6	CTS(A') - Clear To Send	Input
7	GND - Ground	n/a
8	RTS(B) - Request To Send	Output
9	RT - Receive Termination	Output
10	SD(A) - Send Data	Output
11	SD(B) - Send Data	Output
12	RD(A') - Receive Data	Input
13	RD(B') - Receive Data	Input
14	CTS(B') Clear To Send	Input
15	RTS(A) - Request To Send	Output

System Configurations

The Miniconverter can be used in a point-to-point configuration as described above, or in a multidrop configuration with the host device configured as the master and one or more PLCs configured as slaves.

The multidrop configuration requires a straight through (1 to 1) cable from the Miniconverter's RS-422 port to the first slave PLC's SNP port. Other slaves will require a daisy chain connection between slaves. A maximum of eight devices can be connected in an RS-422 multidrop configuration. All of the devices must have a common ground. If ground isolation is required, you can use the GE Fanuc Isolated Repeater/Converter (IC655CCM590) in place of the Miniconverter.

When using the Miniconverter with a modem connection, it may be necessary to jumper RTS to CTS (consult the user's manual for your modem).

Cable Diagrams (Point-To-Point)

When connecting the Miniconverter to IBM PC and compatible computers with hardware handshaking, the following cable connections should be used:

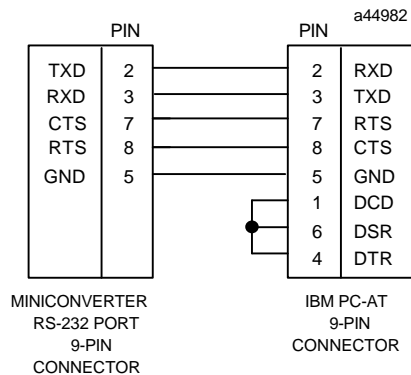

The following table shows the Miniconverter's specifications

Mechanical:	
RS-422	15-pin D shell male for direct mounting to Series 90 or VersaMax serial port.
RS-232	9-pin D shell male for connection to RS-232 serial port of a Workmaster II computer or Personal Computer.
Electrical and General:	
Voltage Supply	+5 VDC (supplied by PLC power supply)
Typical Current	Version A (IC690ACC901A) - 150 mA Version B (IC690ACC901B) - 100 mA
Operating Temperature	0 to 70° C (32 to 158° F)
Baud Rate	38.4K Baud maximum
Conformance	EIA-422 (Balanced Line) or EIA-423 (Unbalanced Line)
Ground Isolation	Not provided

VersaPro License Transfer Procedure

Use this procedure to transfer your license from one computer to another. Usually, a floppy disk is used to transfer a license but a network shared directory (write-able by both machines) can also be used. In this example, a floppy disk is assumed. The floppy disk does not need to be reformatted.

Step 1. Register Machine (performed on the unlicensed machine)

To start the Register Now! Program, go to the Windows Start menu and choose Programs, GE Fanuc Software, VersaPro, RegisterNow! Click the Next button on the Welcome dialog.

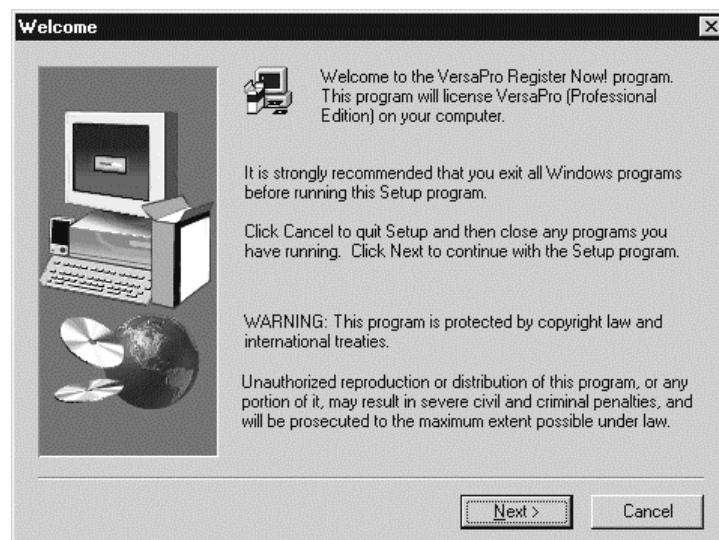

Click the Yes button on the Software License Agreement dialog.

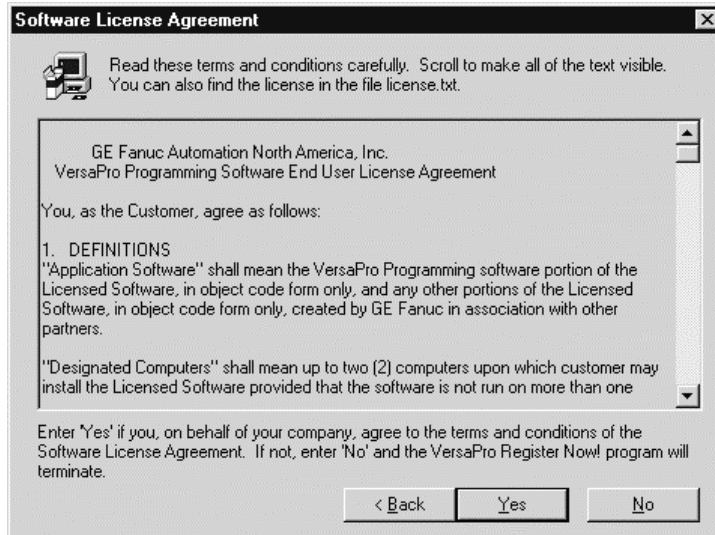

Click the Transfer In License button on the License VersaPro dialog.

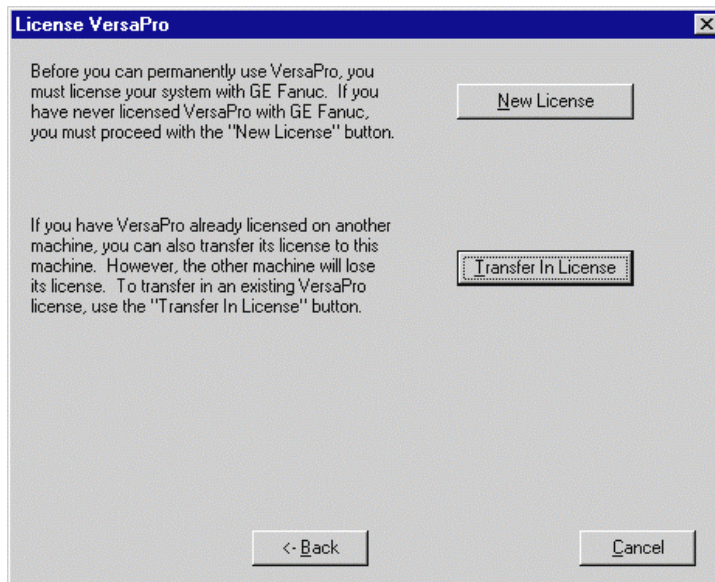

Click the Register Floppy for Transfer In button on the Transfer In License dialog.

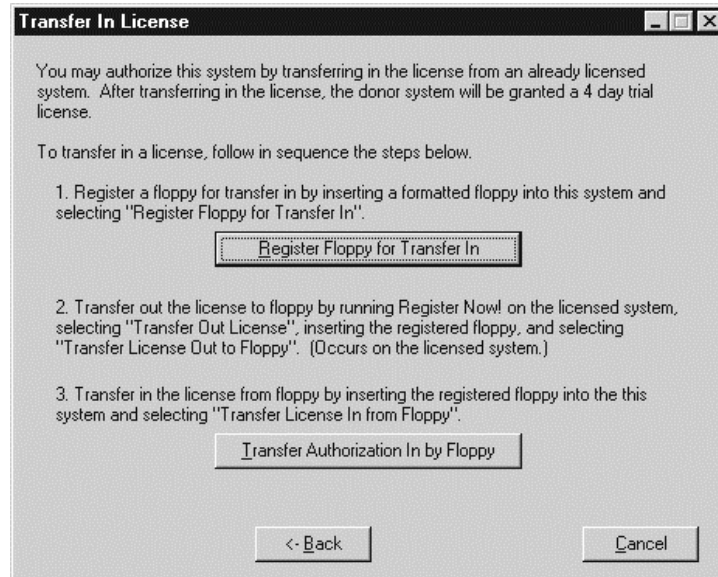

Enter a floppy disk into the floppy drive and click the OK button. (The floppy disk doesn't have to be clean.)

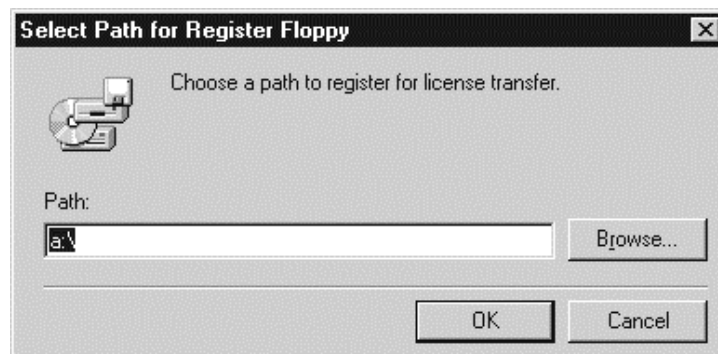

The following message will appear when the floppy is successfully registered.

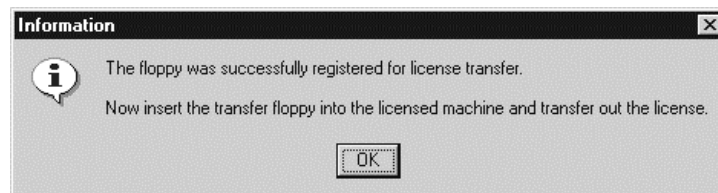

The Transfer In License dialog will remain. **Do not click any buttons. Proceed to the licensed machine to perform “Step 2 – Transfer Out.”**

Step 2. Transfer Out (performed on the licensed machine)

Startup the Register Now! program found under Start->Programs->GE Fanuc Software->VersaPro->RegisterNow! Click the Next button on the Welcome dialog.

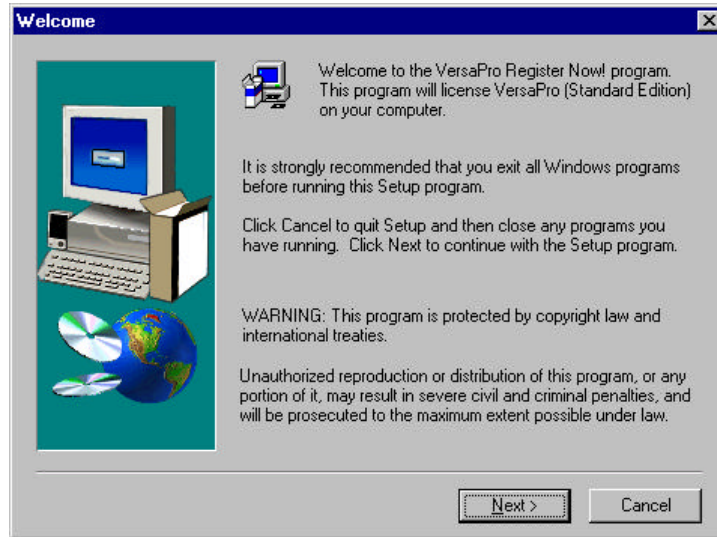

Click the Transfer License Out by Floppy button on the Transfer Out License dialog.

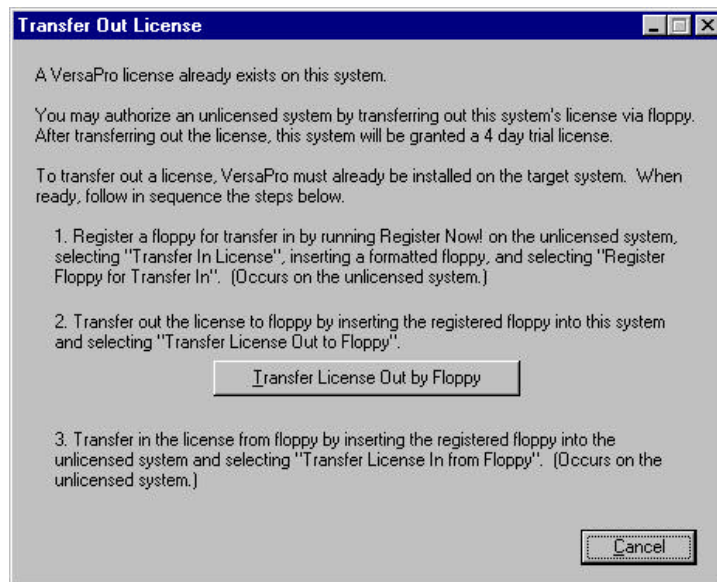

Since we are transferring via a floppy disk, insert the registered floppy disk into the floppy and click the OK button.

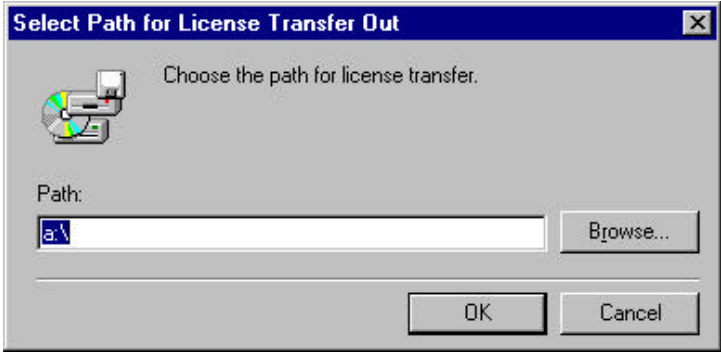

You should see one of the following two messages reflecting a successful license transfer out. Click the OK button.

(Message 1) This message appears when the licensed machine carries only one license. This is the more common of the two. Since the machine's only license is transferred out, a 4 day trial license is assigned to the machine.



or

(Message 2) This message appears when the licensed machine contains multiple licenses and shows how many licenses remain.

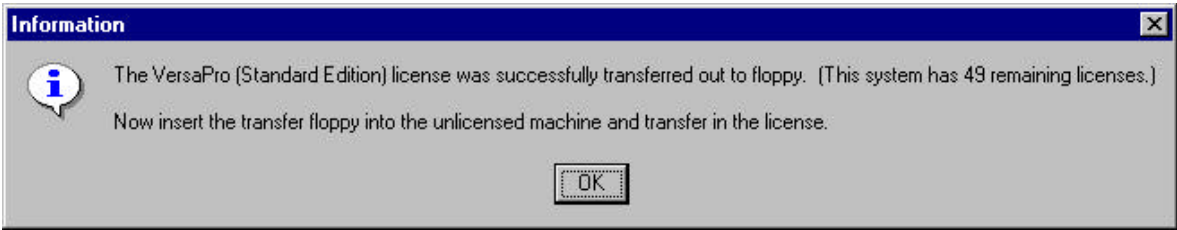

You are finished using this machine. Return to the unlicensed machine with the licensed floppy disk to proceed with "Step 3 – Transfer In."

Step 3. Transfer In (performed on the unlicensed machine)

The Transfer In License dialog should still be visible. Click the Transfer Authorization In by Floppy button.

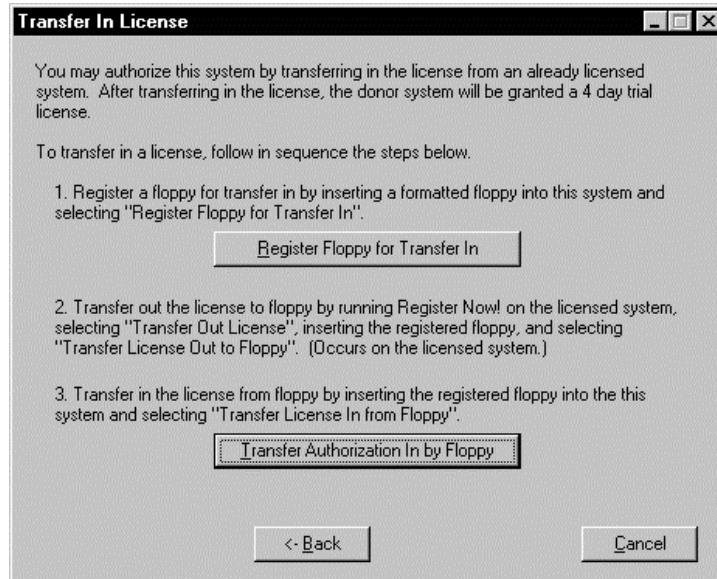

Insert the licensed floppy disk into the floppy drive and click the OK button.

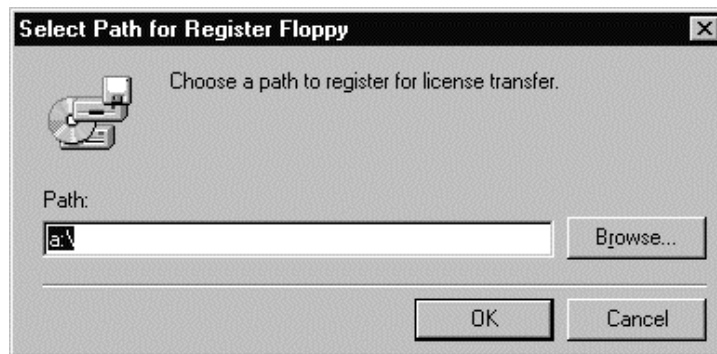

The following message indicates a successful license transfer. Click the OK button to exit the Register Now! program. **You are now ready to run your licensed VersaPro product.**

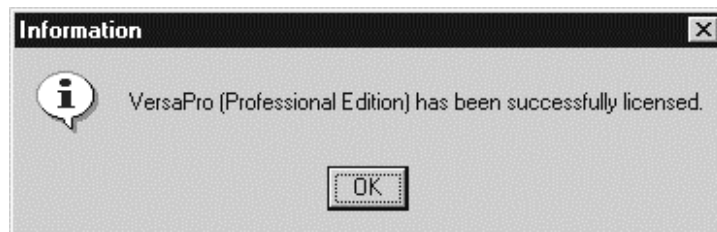

Appendix
D

Using the VersaPro Keyboard

The quick reference card on the next page contains a listing of keyboard shortcuts for VersaPro commands, as well as other programming tips.

D



FANUC

VersaPro™ Programming Software Quick Reference

Cut here

To launch/exit VersaPro

CTRL+ALT+V	Launch VersaPro from Windows; Bring VersaPro into focus.
ALT+F4	Exit VersaPro.
CTRL+ALT+R	Launch Remote IO Manager (Stand Alone Hardware Config) from Windows; Bring Remote I/O Manager into focus.

To modify the VersaPro workspace

F6	Move focus to next block/dockable window.
SHIFT+F6	Move focus to previous block/dockable window.
ALT+0	Show or hide the status bar.
ALT+1	Show or hide the Folder Browser.
ALT+2	Show or hide the Information Window.
ALT+3	Show or hide the Variable Declaration Table.
ALT+6	Show or hide the Local Logic Variable Table.
ALT+F6	Arrange windows so they overlap.
ALT+F7	Arrange windows as horizontal non-overlapping tiles.
ALT+F8	Arrange windows as vertical non-overlapping tiles.
ALT+F9	Arrange icons at the bottom of the window.
CTRL+T	Display the toolbar dialog.
CTRL+E	Display the options dialog.
CTRL+TAB	Display next tab/window to the right.
CTRL+SHIFT+TAB	Display next tab/window to the left.

To perform folder operations

CTRL+N	Create a new Folder.
CTRL+O	Open an existing Folder.
CTRL+SHIFT+A	Save an entire Folder.
F8	Backup a Folder to (*.flb).
CTRL+F8	Restore a Folder from backup (*.flb).
CTRL+B	Create a new Ladder/Instruction List block.
ALT+5	Open _MAIN Block; Bring _MAIN into focus.
ALT+F10	Close all open Blocks.
CTRL+F7	Check selected Block(s).
F7	Check all Blocks in the Folder.
ALT+4	Open Hardware Configuration.

To perform general operations

ESC	Abort the current operation.
CTRL+BREAK	Abort.
DELETE	Delete the selection.
F1	Display help for the item with focus.
INSERT	Inserts a row.
PGUP	Move up a page in the selected editor or table.
PGDN	Move down a page in the selected editor or table.
HOME	Move to the top of the selected editor or table.
END	Move to the bottom of the selected editor or table.
ALT+BACKSPACE	Undo the last action.
ALT+ENTER	Display properties dialog for selected block or folder.
CTRL+A	Select the entire block or table.
CTRL+C	Copy the selection to the Clipboard.
CTRL+INSERT	Copy the selection to the Clipboard.
CTRL+V	Insert Clipboard contents.
CTRL+F3	Find/replace the specified item.
CTRL+G	Moves to a specified location.
CTRL+P	Print the block that has focus.
CTRL+S	Save the block or table that has focus.
CTRL+Y	Redo the previously undone action.
CTRL+Z	Undo the last action.
SHIFT+DELETE	Cut the selection to the Clipboard.
SHIFT+F1	Display help for clicked on buttons, menus and windows.
SHIFT+INSERT	Insert Clipboard contents.

To perform operations in the LD editor

CTRL+-	Decrease font size.
CTRL++	Increase font size.
CTRL+=	Increase font size.
ALT+F3	Navigate to the next coil.
CTRL+←	Draw/erase horizontal shunt to the left.
CTRL+Ⓞ	Draw horizontal shunt to the right.
CTRL+↑	Draw vertical shunt up.
CTRL+↓	Draw vertical shunt down.

Click right mouse button and drag to target location
Connect two cells with a shunt.

To perform operations in the LD and IL editors

F2	Toggle edit mode off/on.
F3	Find next item of defined search criteria.
CTRL+F10	Find specified item in blocks in folder.
CTRL+F11	Go to variable in Variable Declaration Table.
←	Move left by cell.
→	Move right by cell.
↑	Move up by cell.
↓	Move down by cell.
SHIFT+←	Increase/decrease selection area to left.
SHIFT+→	Increase/decrease selection area to right.
SHIFT+↑	Increase/decrease selection area up.
SHIFT+↓	Increase/decrease selection area down.
HOME	If edit mode is off, focus moves to the current row's first cell the first time Home is pressed. Pressing Home again moves focus and to the entire rung. If edit mode is on in the current cell, the cursor moves to the left of the first character in the field.
END	If edit mode is off, focus moves to the current row's last occupied cell the first time End is pressed. Pressing End again, moves focus to the row's last cell. If edit mode is on in the current cell, the cursor moves to the right of the last character in the field.
CTRL+HOME	Move to the first row's first cell.
CTRL+END	Moves to the last row's first cell.
TAB	Move to right one cell.
SHIFT+TAB	Move to left one cell.
ENTER on an empty cell	The Instruction dropdown list is activated. As you type the instruction mnemonic, VersaPro sorts the possible instructions for the specified location.
ENTER on a cell that contains an instruction or operand	The Variable dropdown list is activated. As you type the Variable name, VersaPro sorts the possible variables that are valid for this context. If the instruction is a comment, it is placed in Edit mode.
SHIFT+ENTER on a cell that contains an instruction or operand	The Instruction dropdown list is activated. As you type the instruction mnemonic, VersaPro sorts the possible instructions for the specified location.
SPACEBAR	Toggle selection on/off.
CTRL+SPACEBAR	Toggle selection on/off.
DELETE	Delete the selection.
CTRL+ENTER	Exits a comment that has been placed in Edit mode.

<Instruction Mnemonic>, <Variable Name>
Enter an instruction and variable name at the same time. i.e. "NOCON , DiscreteVarOne."

<Instruction Mnemonic>, <Variable Name>, <Reference Address>
Enter an instruction and define a variable name at the same time. i.e. "NOCON , DiscreteVarTwo, %I12"

<Instruction Mnemonic>, <Variable Name>, <Reference Address>, <Scope>
Enter an instruction and define a variable name at the same time, including variable scope (G = Global, L = Local). i.e. "NOCON , DiscreteVarTwo, %I12, G"
%<Reference Type> Specify the next available PLC reference address. i.e. "%M"

To change a selected variable's on-line value in LD Editor, IL Editor, RVT, and VVT

F10	Write a value to a variable.
F11	Override a discrete variable or reference address.
F12	Toggle a discrete variable or reference address.

To perform operations with the connected PLC

F9	Connect to a specific PLC.
CTRL+F9	Disconnect from PLC.
ALT+F2	Store this folder to PLC.
CTRL+F2	Load from PLC into this folder.
F4	Verify this folder with PLC.
F5	Place the PLC in Run Mode.
CTRL+F5	Place the PLC in Stop Mode.
SHIFT+F4	View PLC status.
ALT+V, ALT+N, ALT+L	Set Monitor Active for All Blocks.
ALT+V, ALT+N, ALT+A	Set Monitor Active for Active Block.
ALT+V, ALT+N, ALT+O	Set Monitor Off.

To change a selected variable's data display format in LD Editor, IL Editor, RVT, or VVT

CTRL+SHIFT+B	Display the value in binary format.
CTRL+SHIFT>D	Display the value in signed decimal format.
CTRL+SHIFT>H	Display the value in hex format.
CTRL+SHIFT>O	Display the value in octal format.
CTRL+SHIFT>R	Display the value in real format.
CTRL+SHIFT>S	Display the value in scientific notation format.
CTRL+SHIFT+U	Display the value in decimal format.

#

####

view tables, 8-2, 8-3

—

_MAIN, 3-1

9

90-30 Rack

configuring, 7-8

90-70 Rack

configuring, 7-8

A

Accessing Hardware

Configuration, 7-2

Adding elements to a View

Table, 8-8

Address

completing in IL Editor, 5-5

completing in LD Editor, 4-9

Advanced User Parameters,

EGD (CPUE05)

format, 7-43

Assigning conversion

variables, 3-22

Assigning temporary variables,

3-15

Audit trail mode

setting, 7-7

Audit Trail Mode

configuring log view, 7-50

Auto Correct, 7-6

Autoconnect options

setting, 1-7

B

Bases (VersaMax)

configuring, 7-23

power supply booster, 7-23

Bitmap

copy as, 4-15

Block logic

converting, 3-22, 3-24

Block properties

viewing, 3-8

Block size, maximum, 3-7

Blocks

_MAIN, 3-1

arranging in browser, 3-8

changing order, 3-9

closing, 3-13

copying between folders, 3-4

deleting, 3-12

inserting, 3-4

locating names, addresses, or
call statements, 3-18

opening, 3-6

saving, 3-13

Boolean expressions

nesting, 5-17

Browser, 2-12

Built-in functions

IL editor, 5-13

C

Cable and connections for
serial port, B-3

Cable diagrams, serial
connection, B-6

Cam blocks

creating, 9-16

deleting, 9-16

duplicating, 9-16

editing, 9-16

properties, 9-17

renaming, 9-17

Cam Editor, 9-14

installing, 9-14

Cam profiles

example, 9-15

using in a Motion program,
9-17

Carriers (VersaMax)

configuring, 7-23

deleting, 7-25

power supply booster, 7-23

Catalog numbers, converters

IC690ACC901, B-8

CCU. *See* Communications

Configuration Utility

Index

- Changing rack type, 7-8
 - Checking Blocks, 3-21
 - Clearing the rack
 - Series 90-30/90-70, 7-11
 - VersaMax, 7-25
 - Clearing the Variable
 - Declaration Table, 6-13
 - Closing blocks, 3-13
 - Comment column
 - IL editor, 5-2
 - Communications
 - connecting to a PLC, 10-2
 - direct serial connect, 10-2
 - ethernet, 10-5
 - modem connection, 10-3
 - multidrop connection, 10-3
 - RIO rack, 7-31
 - serial direct, 10-2
 - TCP/IP, 10-5
 - Communications
 - Configuration Utility
 - guidelines, 10-8
 - Compacting the VDT, 6-14
 - Completing function block
 - parameters, 4-10
 - Completing instruction
 - parameters, 5-5
 - Configuration
 - NIU, 7-30
 - Series 90 Micro, 7-47
 - Series 90-30 or Series 90-70,
7-8
 - VersaMax expansion
 - networks, 7-25
 - VersaMax modular rack,
7-21
 - VersaMax Nano/Micro, 7-45
 - VersaMax Remote I/O rack,
7-30
 - Configuring VersaMax
 - Modules, 7-24
 - Connecting to a PLC, 10-2
 - Constants
 - assigning to function block
parameters, 4-13, 5-7
 - IL editor, 5-11
 - rules, 4-13, 5-7
 - Context-sensitive Menu, 2-14
 - Conversion variables
 - assigning, 3-22
 - Converters
 - IC690ACC901, B-8
 - RS-232/RS-485, B-5
 - Converting Blocks, 3-22, 3-24
 - guidelines, 3-24
 - Converting Rack Systems,
7-54
 - Copy as bitmap, 4-15
 - CPU model checking, 10-11
 - CPU Redundancy, 7-13
 - CPU, configuring
 - series 90-30/90-70, 7-9
 - VersaMax, 7-23
 - Creating a New Folder, 2-2
 - based on VersaPro folder, 2-4
 - Creating and modifying
 - variables, 6-5
 - Creating New
 - Reference/Variable View
Tables, 8-7
 - Cross-reference of variables
 - creating, 6-14
 - CSM, 2-14
 - Customizing display
 - IL editor, 5-3
 - LD editor, 4-3
 - Customizing display format,
8-6
 - Customizing View Tables, 8-4
 - Cut, Copy, Paste
 - IL editor, 5-8
 - LD editor, 4-15
 - using in the variable
 - declaration table, 6-8
 - view tables, 8-10
- ## D
- Date and time
 - viewing and changing, 10-18
 - Deleting
 - in LD editor, 4-16
 - Deleting blocks, 3-12
 - Deleting Carriers (VersaMax),
7-25
 - Deleting rack modules (Series
90-30/90-70), 7-11
 - Deleting rack modules
(VersaMax), 7-25

Deleting variables, 6-12
Device, CCU
 configuring, 10-3
 DEFAULT, 10-2
Direct serial port connection,
 10-2
Display format, changing
 monitored logic, 10-21
 Reference View Tables, 8-5
Display format, changing
 Variable View Tables, 8-6
Display options
 setting, 1-6
Docking, 2-15

E

Editing Ladder Logic, 4-14
EGD. *See* Ethernet Global
 Data
Empty row
 inserting, 4-16
ENO
 using in IL editor, 5-18
Error checking
 IL editor, 5-19
Error color
 setting, 7-7
Ethernet communications, 10-5
Ethernet Global Data
 advanced user parameters,
 7-43
 configuration, 7-35
 configuring interface adapter
 name, 7-36
 name resolution and routing
 table, 7-36
 PLC timing considerations,
 7-39
 restoring, 7-43
 setting aliases, 7-36
Ethernet interface adapter
 name, 7-36
Expansion networks,
 VersaMax
 configuring, 7-25
Expansion Racks (Series 90-
 30/90-70)
 configuring, 7-10
Exporting Variables, 6-17

GFK-1670C

Index

EZ Program Store, 10-16

F

Fault details, 11-3
Fault Tables, 11-1
 clearing, 11-5
 fault details, 11-3
 printing, 11-6
 selecting font, 11-6
 viewing, 11-2
Find in blocks, 3-18
Find/Replace, 3-19
Finding program rung, row or
 variable, 3-17
Flash memory, 10-15
Folder
 creating, 2-2
 creating based on existing
 VersaPro folder, 2-4
 names, 2-10
 properties, 2-19
Folder components, 1-3
 changing order, 3-9
Font
 changing in IL Editor, 5-3
Format Reference Table, 8-5
Function Address, 4-5
Function block parameters
 completing, 4-10
Function blocks
 IL editor, 5-12
 LD editor, 4-5
Function Data Length, 4-5
Function properties, 4-9, 5-5
Function toolbar
 compact, 4-6
 expanded, 4-7
Functions
 built-in, 5-13
 IL editor, 5-12
 LD editor, 4-5

G

Genius bus configuration, 7-11
Go To, 3-17
Go To variable

Index-3

Index

locating variables in the
VDT, 6-7

H

Hardware Configuration

accessing, 7-2
converting rack systems, 7-54
log window, 7-50
menus, A-11
overview, 7-2
printing, 7-54
reference view, 7-49
setting, 1-4
setting options, 7-7
shortcut keys, 7-6
toolbar, 7-3

High speed counter

Series 90 Micro, 7-48
VersaMax Nano/Micro, 7-46

Highest references used, 6-14

I

I/O Fault Table, 11-1

IBM-AT/XT serial port, B-5

IL editor

built-in functions, 5-13

IL Editor

customizing display, 5-3
entering instructions, 5-4
nesting Boolean expressions,
5-17

IL instructions

entering, 5-4

IL language

overview, 5-9

Importing Variables, 6-15

Information window, 2-12, 2-13

Inserting an empty row, 4-16

Inserting objects, 3-7

Installing

Cam Editor, 9-14
VersaPro, 1-2

Instruction column

IL editor, 5-2

Instruction List Editor

overview, 5-2

Instruction parameters

completing in IL editor, 5-5

Instructions

entering in IL Editor, 5-4
entering in LD Editor, 4-5
selecting in IL editor, 5-4

K

Keyboard entry

LD editor, 4-9

Keyboard shortcuts

HWC, 7-6

L

Label column

IL editor, 5-2

Ladder display options

customizing, 4-3

Ladder Logic

editing, 4-14

LD Editor

customizing options, 4-3
entering instructions, 4-5
overview, 4-2

LD functions

toolbar, 4-6

LD Functions

toolbar, 4-7

LD instructions

entering using keyboard, 4-9
entering using toolbar, 4-6,
4-8

LD Instructions

data length, 4-5
entering, 4-5
function address, 4-5

LD_BOOL, 5-9

LD_ENO, 5-9

LD_INT, 5-9

LDN_BOOL, 5-9

Length

completing in IL Editor, 5-5
completing in LD Editor, 4-9

License

transferring, C-1

Load/Store/Verify RIO

configuration, 7-31

Loading

folder from PLC, 10-12

- RIO configuration, 7-33
 - VersaMax hardware configurations, 7-29
- Local Logic editor, 9-7
- Local Logic Variable Table, 9-8
- Locked blocks
 - importing from Logicmaster, 2-7
- Log file size, setting, 7-7
- Log View
 - hardware configuration, 7-50
- Logic editor window, 2-12

M

- Maximum block size, 3-7
- Memory
 - EZ Program Store, 10-16
 - flash memory, 10-15
- Menu bar and toolbars, 2-12
- Menus
 - HWC, A-11
 - VersaPro, A-1
- Miniconverter kit
 - cable diagrams, B-10
 - RS-232 port pin assignments, B-9
 - RS-422 (SNP) to RS-232, B-8
 - RS-422 port pin assignments, B-9
 - system configurations, B-10
- Modem issues, 10-9
- Modules
 - Series 90-30/90-70, 7-10
 - VersaMax, 7-24
- Monitoring logic, 10-20
- Motion Program editor, 9-4
- Motion Program/Local Logic
 - blocks
 - restoring, 9-12
- Motion Program/Local Logic
 - options
 - setting, 9-3
- Multidrop connections, B-7
- Multiple instances of
 - VersaPro, 1-3

N

- Name Resolution
 - restoring, 7-43
- Name Resolution and Routing Table configuration, 7-36
- Nesting Boolean expressions, 5-17
- New Reference View Table, 8-7
- New Variable View Table, 8-7
- Next reference assignment, 7-7
- NIU
 - configuring, 7-30

O

- Objects
 - inserting, 3-7
- Online viewing
 - view tables, 8-14
- Opening blocks, 3-6
- Operand column
 - IL editor, 5-2
- Operators
 - valid in IL editor, 5-9
- Options
 - display, 8-4
 - hardware configuration, 7-7
 - Motion Program/Local Logic, 9-3
- Override reference
 - reference view tables, 8-14
- Overrides
 - searching for, 10-22

P

- Parameter Editor
 - editing tips, 7-4
 - error color, 7-5
 - using, 7-3
- Parameter view
 - (tabbed/spreadsheet), 7-7
- Passwords
 - CCU, 10-8
 - folder, 2-18
- Paste
 - LD editor, 4-16

Index

PLC

- configuring, 7-8, 7-21, 7-45, 7-47
- run/stop mode, 10-19
- PLC communication
 - connecting, 10-2
 - direct serial port connection, 10-2
- PLC Fault Table, 11-1
- PLC Hardware
 - setting, 1-4
- PLC status information, 10-17
- Point-to-point RS-232
 - connections, B-6
- Power supply
 - series 90-30/90-70, 7-9
- Power Supply (Series 90-30)
 - configuring, 7-9
- Power Supply (VersaMax)
 - configuring, 7-24
- Power Supply Bases (VersaMax)
 - adding, 7-23
- Power Supply Booster Bases
 - configuring, 7-23
- Printing Hardware
 - Configuration, 7-54
- Properties
 - blocks, 3-8
 - folder, 2-19
- Pulse train output
 - Series 90 Micro, 7-48
 - VersaMax Nano/Micro, 7-46
- Pulse width modulation
 - Series 90 Micro, 7-48
 - VersaMax Nano/Micro, 7-46

Q

- Quick reference, D-1

R

- Rack modules (Series 90-30/90-70)
 - adding, 7-10
 - configuring, 7-10
 - deleting, 7-11
- Rack modules (VersaMax)

- deleting, 7-25
- Rack type (Series 90-30/ 90-70)
 - changing, 7-8
- Rack, clearing
 - Series 90-30/90-70, 7-11
 - VersaMax, 7-25
- Real-time updates, 10-20
- Redo, 3-14
- Redundancy
 - CPU, basic, 7-13
- Reference Address column
 - IL editor, 5-2
- Reference View
 - hardware configuration, 7-49
- Reference View Tables
 - adding an address, 8-9
 - changing display format, 8-5
 - conversion**, 8-3
 - creating new, 8-7
 - overview, 8-3
- Remote ethernet interfaces
 - setting aliases, 7-36
- Remote I/O
 - communications, 7-31
 - configuring, 7-30
 - load/store/verify, 7-31
- Reserved words, 6-4
- Reset
 - parameters, 7-5
- Restoring
 - Motion/Local Logic blocks, 9-12
- Restoring EGD and Name
 - Resolution, 7-43
- Restricting folder access, 2-18
- RIO. *See* Remote I/O
- RS-232 point-to-point
 - connections, B-6
- RS-232/RS-485 converter, B-5
- RS-422 interface, B-2
- Rules for constants, 4-13, 5-7
- Run Mode, 10-19

S

- Saving blocks, 3-13
- Saving View Tables, 8-13
- Search and Replace, 3-19

Selected blocks

- printing, 2-21
- Selecting instructions, 5-4
- Selecting logic, 4-14
 - LD editor, 4-14
- Serial parameter settings, 10-8
- Serial port
 - IBM-AT/XT, B-5
- Serial port and cables,
 - appendix C
 - cable and connector
 - specifications, B-3
 - IBM-AT/XT serial port, B-5
 - multidrop connections, B-7
 - RS-232 point-to-point
 - connections, B-6
 - RS-232/RS-485 converter,
 - B-5
 - RS-422 interface, B-2
 - serial cable diagrams, B-6
 - Serial port, B-4
- Serial port update device. *See*
 - EZ Program Store
- Series 90 Micro
 - configuring, 7-47
- Shared module IDs
 - VersaMax, 7-29, 7-33
- Shortcut Keys
 - hardware configuration, 7-6
- SNF File
 - exporting variables, 6-17
 - importing variables, 6-15
- Sorting variables, 6-12
- Specifications
 - serial port cables, B-3
- ST_BOOL, 5-9
- ST_DINT, 5-10
- ST_INT, 5-10
- Starting VersaPro, 1-2
- Status bar, 2-12
- Status information
 - PLC, 10-17
- STN_BOOL, 5-9
- Stop Mode, 10-19
- Storing
 - folder to PLC, 10-10
 - Motion/Local Logic, 9-11
 - RIO configuration, 7-32
- Syntax checks
 - performing, 3-21

T

- Tabs
 - variable declaration table, 6-2
- Target communications
 - status information, 10-17
- TCP/IP, 10-5
- Temporary variables
 - assigning, 3-15
 - defining, 5-19
- Timed interrupt
 - 90-30 block name, 3-3
- Timing Considerations
 - for EGD, 7-39
- Toggle reference
 - reference view tables, 8-14
- Toolbar
 - compact, 4-6
 - expanded, 4-7
- Toolbars
 - hardware configuration, 7-3,
 - 7-8
 - VersaPro, A-7
- Transfer utilities
 - read/write/verify EZ Program Store, 10-16
 - read/write/verify flash memory, 10-15
- Transfer Utilities
 - clearing PLC Memory, 10-13
 - loading from the PLC, 10-12
 - loading from the PLC, 10-10
 - storing to the PLC, 10-10
 - verifying folder data, 10-14
- Transferring your VersaPro
 - license, C-1
- Type
 - instructions, 4-5

U

- Undo, 3-14
- Undo levels
 - setting, 7-7
- Unequal after check all or
 - verify, 10-11
- Unused variables
 - finding, 6-14

Index

Update in progress or
unavailable, 10-21

V

Value column

IL editor, 5-2

Variable Declaration Table, 2-

12, 6-1

address field, 6-3

clearing, 6-13

compacting, 6-14

description field, 6-3

EXT field, 6-4

field descriptions, 6-3

length field, 6-3

name field, 6-3

navigating, 6-6
navigating with the keyboard,
6-6

navigating with the mouse,
6-6

overrides field, 6-4

retentive field, 6-4

saving edits, 6-13

scope field, 6-3

stored value field, 6-3

tabs, 6-2

type field, 6-3

Variable Name, 4-11

Variable View Table

customizing display, 8-6

Variable View Tables

creating new, 8-7

overview, 8-2

Variables

assigning to function block
parameters, 4-10

assigning to instruction
operands, 5-5

creating, 6-5

creating when adding blocks,
3-15

deleting, 6-12

exporting, 6-16, 6-17

Go To, 6-7

importing and exporting,
6-15

locating in the VDT, 6-7

modifying, 6-5

replacing in LD Editor, 4-12

sorting, 6-12

using Cut, Copy, Paste and
Drag and Drop, 6-8
with overlaps, 4-10

VersaMax expansion networks
configuring, 7-25

VersaMax modules

shared IDs, 7-29, 7-33

VersaMax Nano/Micro

configuring, 7-45

VersaMax Rack

configuring, 7-21

VersaMax Remote I/O

configuring, 7-30

VersaPro

overview, 1-3

View Tables

adding entries, 8-8

customizing, 8-4

options, 8-4

saving, 8-13

viewing online, 8-14

W

Warning color

setting, 7-7

Windows

docking, 2-15

hiding, 2-15

moving and resizing, 2-15

Word for word changes, 10-11

Workbench options

setting, 1-4

Workbench Window, 1-4

Writing

a value to a reference, 8-10

Z

Zoom ratio

setting, 4-4