

GFK-1425
New In Stock!
GE Fanuc Manuals

[http://www.pdfsupply.com/automation/ge-fanuc-manuals/operator-
interface/GFK-1425](http://www.pdfsupply.com/automation/ge-fanuc-manuals/operator-interface/GFK-1425)

operator-interface

1-919-535-3180

CIMPLICITY Display Station Touch Display: (IC752CTD400/450)

www.pdfsupply.com

Email: sales@pdfsupply.com

GFK-1425
New In Stock!
~~GE Fanuc Manuals~~

[http://www.pdfsupply.com/automation/ge-fanuc-manuals/operator-
interface/GFK-1425](http://www.pdfsupply.com/automation/ge-fanuc-manuals/operator-interface/GFK-1425)

operator-interface
1-919-535-3180

CIMPLICITY Display Station Touch Display: (IC752CTD400/450)

www.pdfsupply.com

Email: sales@pdfsupply.com



GE Fanuc Automation

Programmable Control Products

*CIMPLICITY® Display Station
Touch Display:*

IC752CTD400/450

GFK-1425B

March 1998

Warnings, Cautions, and Notes as Used in this Publication

Warning

Warning notices are used in this publication to emphasize that hazardous voltages, currents, temperatures, or other conditions that could cause personal injury exist in this equipment or may be associated with its use.

In situations where inattention could cause either personal injury or damage to equipment, a Warning notice is used.

Caution

Caution notices are used where equipment might be damaged if care is not taken.

Note

Notes merely call attention to information that is especially significant to understanding and operating the equipment.

This document is based on information available at the time of its publication. While efforts have been made to be accurate, the information contained herein does not purport to cover all details or variations in hardware or software, nor to provide for every possible contingency in connection with installation, operation, or maintenance. Features may be described herein which are not present in all hardware and software systems. GE Fanuc Automation assumes no obligation of notice to holders of this document with respect to changes subsequently made.

GE Fanuc Automation makes no representation or warranty, expressed, implied, or statutory with respect to, and assumes no responsibility for the accuracy, completeness, sufficiency, or usefulness of the information contained herein. No warranties of merchantability or fitness for purpose shall apply.

The following are trademarks of GE Fanuc Automation North America, Inc.

Alarm Master	GENet	PowerMotion	Series One
CIMPLICITY	Genius	ProLoop	Series Six
CIMPLICITY PowerTRAC	Genius PowerTRAC	PROMACRO	Series Three
CIMPLICITY 90-ADS	Helpmate	Series Five	VuMaster
CIMSTAR	Logicmaster	Series 90	Workmaster
Field Control	Modelmaster		

Content of This Manual

This manual describes the features and operation of the following CIMPLICITY Display Station Touch Display products:

Catalog Number

IC752CTD400

IC752CTD450

Related Publications

GFK-1189	<i>CIMPLICITY® HMI for Windows NT™ and Windows® 95 Important Product Information</i>
GFK-1180	<i>CIMPLICITY® HMI for Windows NT™/CIMPLICITY HMI for Windows® 95/CIMPLICITY Server for Windows NT™ Base System User Manual</i>
GFK-1181	<i>CIMPLICITY® HMI for Windows NT™/CIMPLICITY HMI for Windows® 95/CIMPLICITY Server for Windows NT™ Device Communications Manual</i>
GFK-1396	<i>CIMPLICITY® HMI for Windows NT and Windows 95 CimEdit Operation Manual</i>
GFK-1491	<i>Important Product Information</i>

At GE Fanuc Automation, we strive to produce quality technical documentation. After you have used this manual, please take a few moments to complete and return the Reader's Comment Card located on the next page.

Product Features	2
Display and Touch Screen	3
Floppy Disk Drive Unit	3
Hardware Installation	4
Mounting Guidelines	4
Mounting Procedure	6
Installing ISA-Compatible Cards.....	7
I/O Address and IRQ Allocation	8
Reserved I/O Address.....	8
Touch Screen Port Address	8
Installing the Floppy Disk Drive.....	10
Changing the Air Filter	11
To change the air filter element:	11
Connection	12
AC Power Input	13
Keyboard.....	13
Serial Communication Cables.....	14
Printer Port LPT1 (Parallel Port)	15
Floppy Disk Drive Interface.....	15
Initial Startup	16
Powering Up the Touch Display Unit.....	16
Setting Up Windows 95 Systems (IC752CTD400).....	16
Installing Network Driver on Microsoft Windows 95 Systems (IC752CTD400).....	17
Configuring the Touch Display to Run on a Microsoft Network.....	18
Setting up Windows NT Systems (IC752CTD450).....	19
Installing Network Driver on Microsoft Windows NT Systems (IC752CTD450).....	20
Login Recommendation.....	21
Registering Your CIMPLICITY Software.....	21
Installing Application Software	22
External CD-ROM Drive	22
Touch Screen Driver for Windows	22
Shutting Down the Computer	23
System Operation	23
External Mouse	23
CIMPLICITY Software	23
Communications	23
BIOS Settings	24
Interrupt Requests and I/O Assignments	25
Diagnostics and Troubleshooting	26
Self-Test Diagnostics	26
System Test and Initialization	26

Contents

System Configuration Verification	26
Troubleshooting	27
Powerup	27
Display	28
Memory	28
Touch Screen	29
External PS/2 Mouse	29
Keyboard	29
Communications	30
PLC/CPU Connection	30
MODBUS RTU Communications	31
Network Communications	31
Printing	32
Corrective Actions	33
Auto Logon Error Message	33
Calibrating the Touch Screen	33
CMOS Checksum Error	34
Frequently Asked Questions	35
Hardware FAQs	35
Software FAQs	36
Specifications	37

Figure 1. Touch Display Unit Dimensions 5
Figure 2. Panel Cutout Dimensions 6
Figure 3. Mounting the Touch Display Unit 6
Figure 4. Card Clamp 7
Figure 5. Jumper Locations 9
Figure 6. Floppy Disk Drive Mounting 10
Figure 7. Filter Element Location 11
Figure 8. Touch Display Connectors 12

Contents

Table 1. Touch Display Features.....	2
Table 2. Touch Screen (Custom COM) I/O address	9
Table 3. Touch Screen (Custom COM) IRQ.....	9
Table 4. Connector Listing.....	12
Table 5. IRQ Table.....	25
Table 6. I/O Port Range Table.....	25

CIMPLICITY® DISPLAY STATION

GFK-1425B

March 1998

Touch Display Products

IC752CTD400, IC752CTD450

Welcome to GE Fanuc's CIMPLICITY Display Station products. These products provide an integrated hardware and software platform for running CIMPLICITY HMI applications. The Touch Display incorporates CIMPLICITY HMI software for Windows and either Microsoft Windows® 95 **or** Microsoft Windows NT® software (depending on model). The 10.4" active matrix, thin film transistor (TFT) color displays provide a large viewing area with crisp color and contrast.

The Touch Display incorporates CIMPLICITY HMI software for Windows, and either Microsoft Windows® 95 **or** Microsoft Windows NT® software (depending on model). All Display Stations come preloaded with the full point count version of CIMPLICITY HMI software.



The Touch Display members of the Display Station family feature a fully self contained Pentium computer with a built-in 640 x 480 pixel flat screen display and touch-screen surround, housed in an industrial enclosure, and weighing less than 11kg (25 lbs). The 3.5 inch disk drive adds 1kg (2.2lbs) to the weight.

The complete unit is housed within a compact, rugged metal enclosure. The unit is supplied completely assembled and requires only mounting and connecting. Only one panel cut-out is required to mount the unit. The use of special clips that secure the unit to the panel eliminates the need for mounting holes.

Product Features

When you purchase a CIMPLICITY Touch Display system, you receive:

- CIMPLICITY Display Station industrial computer with CIMPLICITY HMI and operating system software installed.
- Power cord
- Floppy disk drive (3.5-inch)
- Installation hardware
- CIMPLICITY Display Station Data Sheet which describes specifics of the hardware and software for your particular system
- CIMPLICITY Display Station system documentation
- CIMPLICITY software licenses and license agreements
- Ethernet driver floppy disk and manual
- Touch screen driver floppy disk and manual
- Microsoft Windows documentation, software distribution, Certificate of Authenticity and license agreement
- CIMPLICITY software
- Ethernet driver floppy disk and manual
- Touch screen driver floppy disk

Touch Display features are summarized in Table 1.

Table 1. Touch Display Features

Operating system IC752CTD400 IC752CTD450	Windows 95 Windows NT
CIMPLICITY HMI software	Development and Runtime software
CPU	Pentium, 133 MHz
Hard disk	1.2 GB
Floppy disk drive	3.5 inch, 1.44 Mbyte
RAM	32 MB
Display	Color TFT (thin film transistor) active matrix LCD with touch screen surround
Parallel ports	one
Serial ports	Two RS-232

Display and Touch Screen

The Touch Display features a color liquid crystal display (LCD) with a touch screen surround. The touch-screen surround, which is an integral part of the front panel on all Touch Display Flat Screen models, makes operation of a configured system more intuitive by allowing the operator to interface with the system by simply touching the screen.

The performance of the Touch Display unit is not affected by bright sunlight. The system can also differentiate between a true touch operation and a beam failure, allowing the system to continue operation under adverse conditions.

Floppy Disk Drive Unit

A floppy disk drive (IC752FPY000), interface cable and connector are included with the Touch Display unit. The disk drive unit is housed in a metal case that can be attached to the rear panel of the Touch Display enclosure.

Note

Using the disk drive that is provided with the Touch Display unit will ensure compatibility. The use of other types of drives and controllers, which may not be compatible with the Touch Display, is not recommended.

Hardware Installation

This section describes procedures for mounting the Touch Display unit, and installing ISA-compatible cards and the floppy disk drive unit.

A single cut-out is required in the mounting panel. No extra holes are required. Instead, ten spring-loaded retaining clips are supplied to secure the unit from behind the panel.

Note

The Touch Display unit with processor card weighs 11kg (25lbs) approx. The 3.5-inch disk drive adds 1kg (2.2lbs) to the weight when installed.

Mounting Guidelines

When selecting a location for the Touch Display unit, make sure that there will be enough space for access to the connectors, located on the right side of the unit. For unit dimensions, refer to Figure 1. The mounting location for the Touch Display unit should meet the following requirements:

- The panel into which the unit is mounted should provide protection from dust, dirt and water in an industrial environment.
- The panel should be capable of supporting the weight of the Touch Display unit without distortion.
- Maximum panel thickness is 10mm (0.39 inch).
- Allowance should be made for air flow. A fan draws in air through a filter mounted on the side of the unit. Warm air is expelled through slots in the opposite side panel (refer to Figure 1).

Note

All ten mounting clips must be installed to achieve a good seal between the Touch Display unit and the mounting panel.

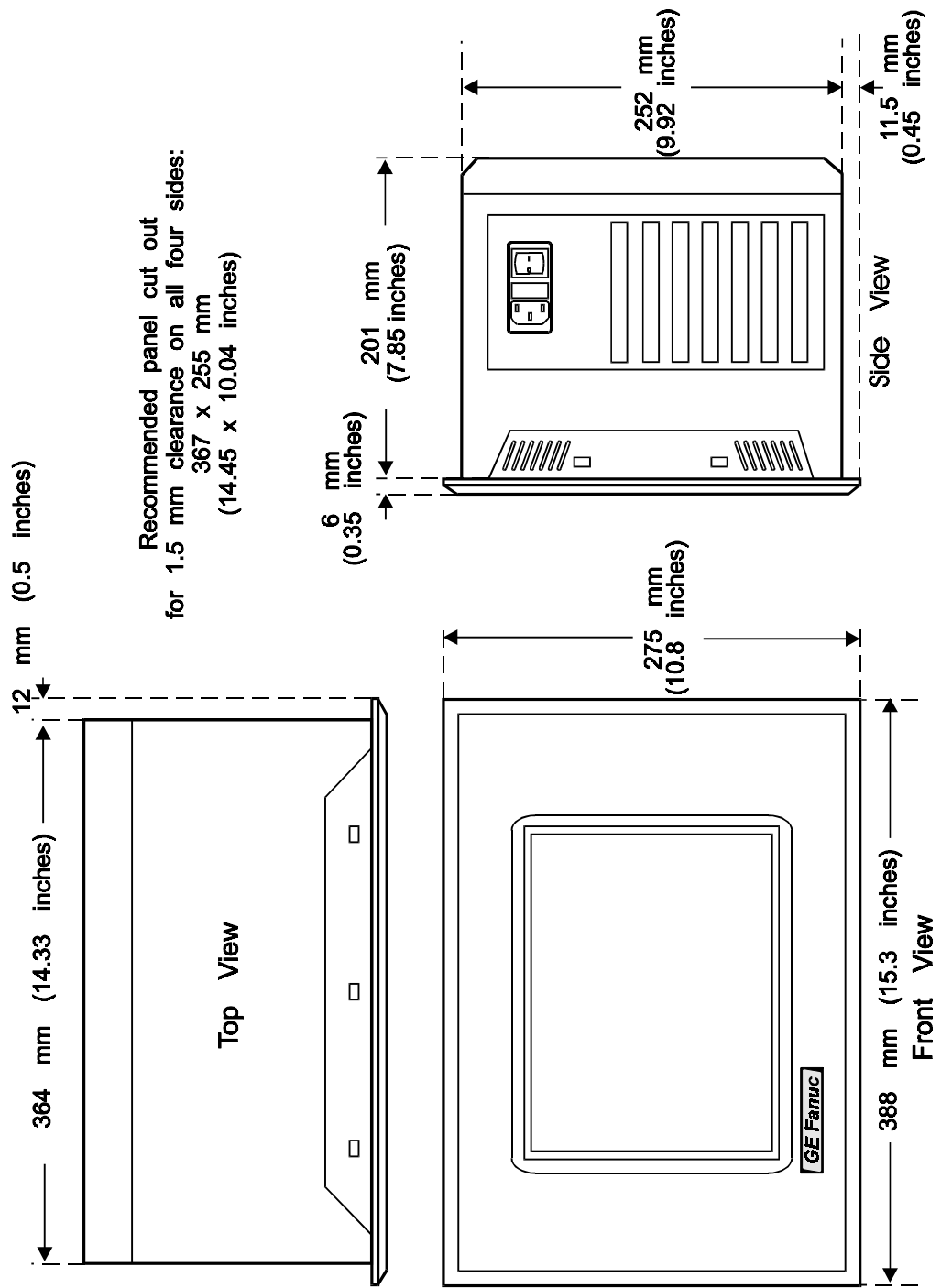

Figure 1. Touch Display Unit Dimensions

Mounting Procedure

1. Cut out the panel to the dimensions shown. The cut-out dimensions of 367 x 255mm (14.45 x 10.04 inches) allow a 1.5mm (0.06 inch) clearance on each edge of the Touch Display unit.

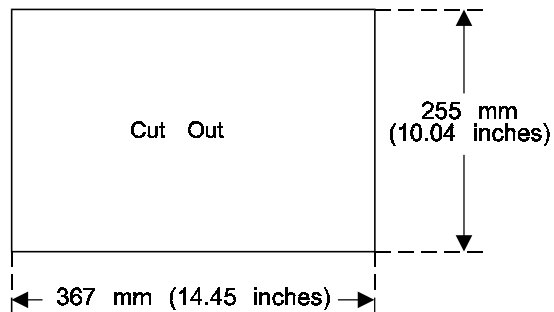

Figure 2. Panel Cutout Dimensions

2. Position the Touch Display unit in the cut-out and fit the ten spring-loaded retaining clips into the slots. **All ten clips must be installed to achieve a good seal.**

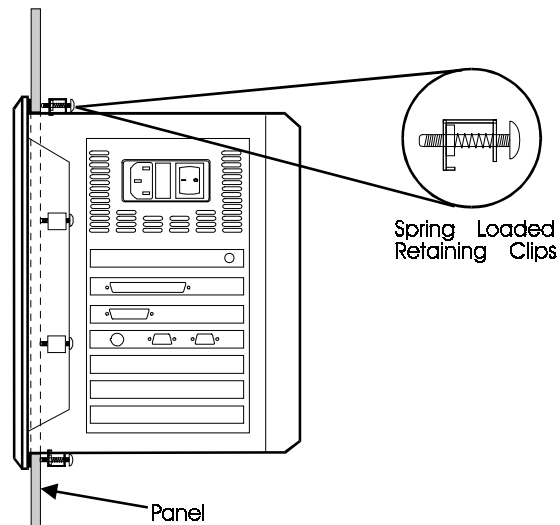

Figure 3. Mounting the Touch Display Unit

3. Screw in the tightening screw on each clip so that the nut compresses the spring. To ensure a good seal between the Touch Display unit and the panel, tighten the clips evenly (tighten each of the ten clips in turn, a little at a time).
4. Stop tightening the clips when the springs are fully compressed — at this point the Touch Display unit is locked in place.

Installing ISA-Compatible Cards

The Touch Display rear panel must be removed in order to gain access to the ISA bus cards. There are six screws securing the rear panel. When these are removed, the rear panel can be lifted away from the main unit.

Warning

Switch off the unit and disconnect the main power input before removing the rear panel.

Blanking Plates

Blanking plates are installed on each unused card position. Remove blanking plates as necessary to install new cards. Empty slots must always have a blanking plate installed, otherwise the air flow through the unit will be affected.

Card Clamp

A card clamp bracket, which can accommodate the two standard heights of ISA bus cards, is fixed inside the rear panel. The card clamp bracket has nylon card-securing blocks fitted above each vacant card position. When installing a full height card in one of these positions, remove the long block from the appropriate position on the bracket and replace with a short block.

Full height cards — 114mm (4.5 inches) approx. — are secured by short nylon blocks

Low height cards — 100mm (3.9 inches) approx. — are secured by long nylon blocks

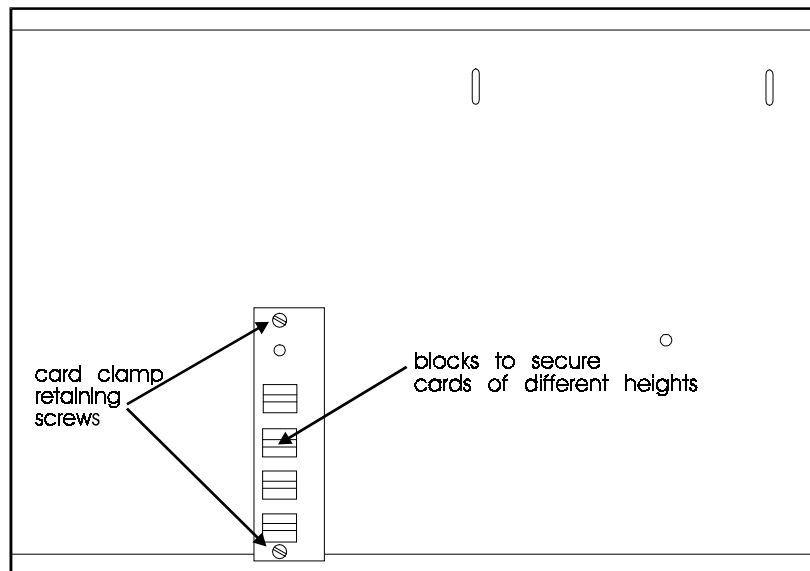

Figure 4. Card Clamp

I/O Address and IRQ Allocation

Caution

For most applications an IRQ cannot be shared by more than one resource. If more than one resource is set to the same interrupt, the application may not respond properly and could cause your machine to lock up.

The I/O address and IRQ number of cards being installed must not conflict with those of cards already installed. Refer to "Interrupt and I/O Assignments" on page 25 for a list of factory-set IRQs. We strongly recommend that you use only the interrupts that are marked available and use them as suggested.

Reserved I/O Address

The Touch Display backplane has an 8-bit I/O mapped register intended for future use. This register is at either 300 hexadecimal or 360 hexadecimal, and is configured by a jumper (link) which is labeled LK12 or LK15. Its position is the same in either case, and is shown in Figure 5.

LK12 (LK15)	IN	300 hexadecimal (factory default)
LK12 (LK15)	OUT	360 hexadecimal

Any hardware adapters installed should not conflict with the above configured address.

Touch Screen Port Address

The Touch Display touch-screen is internally connected as a custom COM port. The I/O addressing and IRQ setting for the port are configured by jumpers and are factory set to I/O address 310 hexadecimal, IRQ5. Changes should not be made to this port unless a hardware adapter that interferes with the factory-set addressing for COM4 is being installed. (Refer to Tables 6 and 7 on page 25.)

Note

Windows based software has been installed to work with the touch-screen via the touch screen driver software (T5driver for Windows 95, TNdriver for Windows NT). Check that the COM port parameters given to the driver match the hardware link settings for the CUSTOM COM port.

The locations of the jumpers LK2 to LK14 (LK15) are shown in Figure 5.

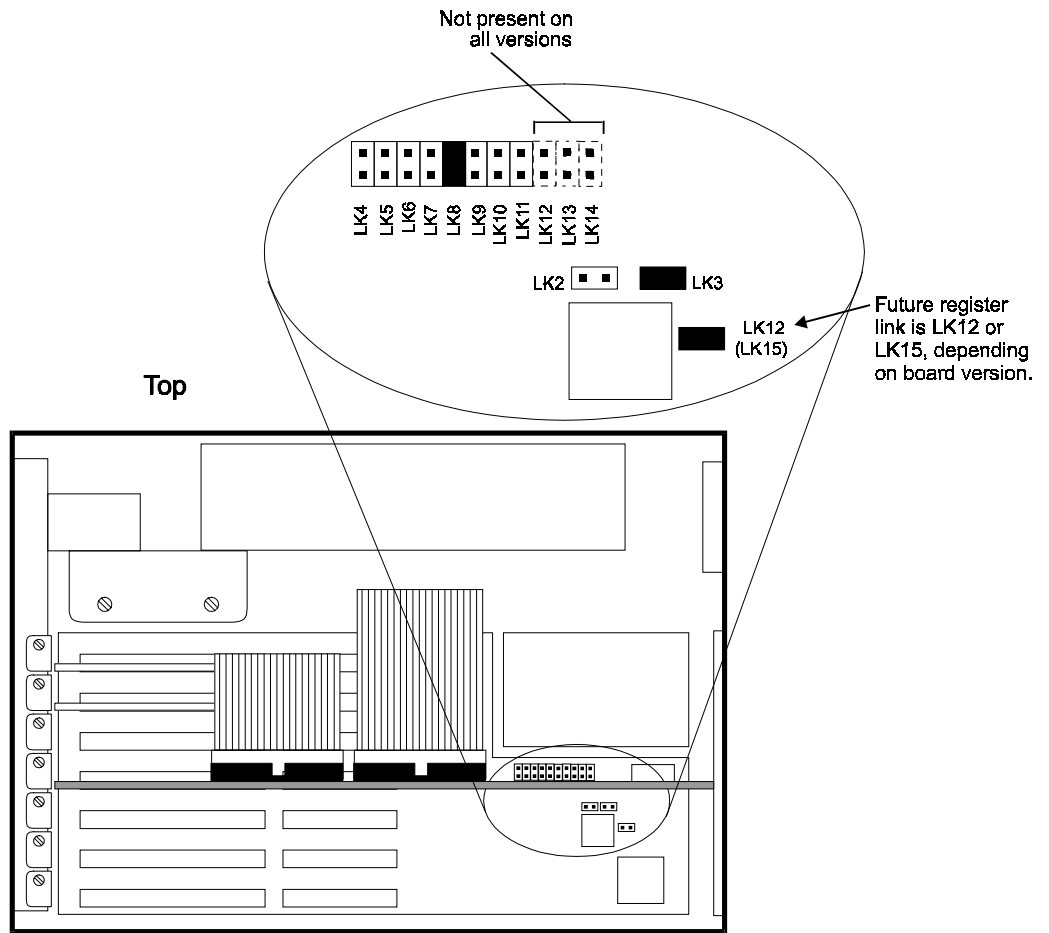

Figure 5. Jumper Locations

Table 2. Touch Screen (Custom COM) I/O address

LK2	LK3	Address
OUT	OUT	Disabled
IN	OUT	2E8 hexadecimal
OUT	IN	310 hexadecimal (factory default)
IN	IN	3E8

Table 3. Touch Screen (Custom COM) IRQ

One jumper determines the IRQ number, depending on its position:

LK6	IRQ3
LK7	IRQ4
LK8	IRQ5 (factory default)
LK9	IRQ6
LK10	IRQ7
LK11	IRQ9

Installing the Floppy Disk Drive

The floppy disk drive is designed for mounting on the rear panel of the Touch Display unit. Two locating slots in the rear panel accept the two metal brackets on the disk drive housing. A thumbscrew fastens the drive assembly to the rear panel. A ribbon cable, terminated with a D-type connector, extends from the disk drive to the floppy disk connector at the side of the unit.

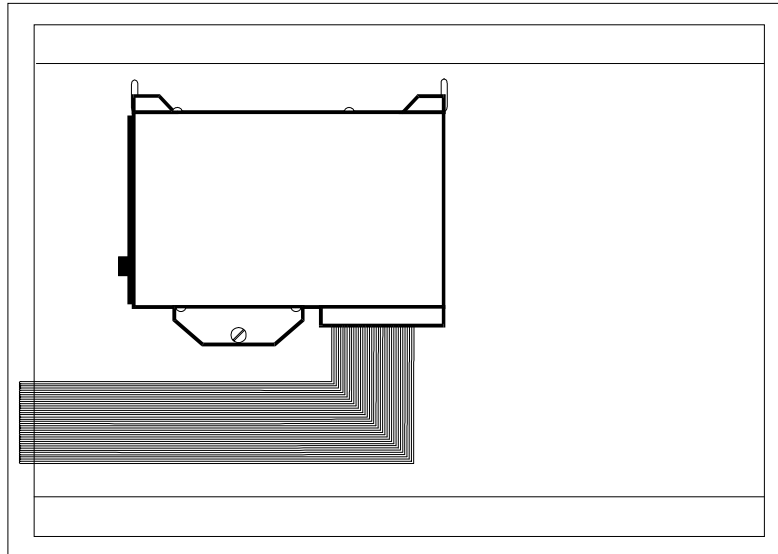

Figure 6. Floppy Disk Drive Mounting

Caution

The Touch Display unit must be powered off before the disk drive connector is connected or disconnected. Failure to observe this precaution will result in damage to the equipment.

Install the 3.5 inch disk drive as follows:

1. Power down the Touch Display unit.
2. Fit the disk drive brackets into the two locating slots on the Touch Display rear panel (refer to Figure 6).
3. For temporary attachment, tighten the fastening screw finger tight. For permanent attachment, use a screwdriver to tighten the screw.
4. Connect the 37-pin D-type connector to the FLOPPY DISK connector and tighten the two securing screws.
5. Power up the Touch Display unit and check that there are no boot up error messages relating to the floppy disk drive.
6. To test the drive, insert a formatted disk and select 3 ½ Floppy (A): in Windows Explorer or File Manager.

Changing the Air Filter

The filter element should be changed every three months, or sooner in dusty environments. If the air filter is not changed at suitable intervals, or a non-approved filter element is installed, the unit may overheat.

Filter Type: 6.35mm (0.25 inch) thick polyester/polyurethane open cell foam (45 ppi)

To change the air filter element:

The filter element is held directly behind the filter plate in the side of the Touch Display unit.

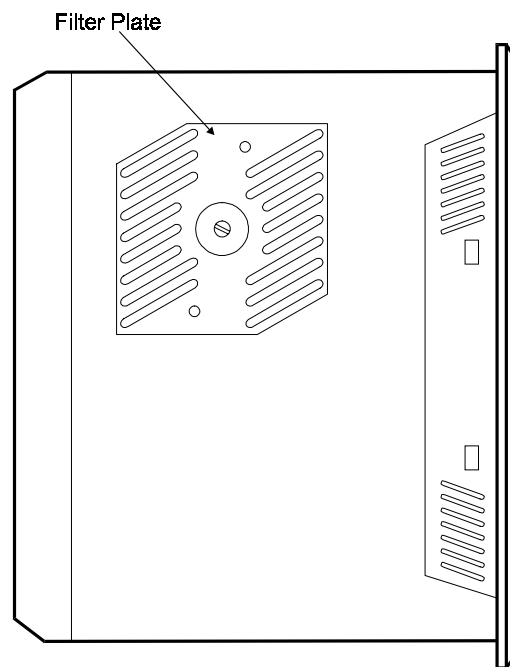

Figure 7. Filter Element Location

Caution

Power down the Touch Display unit before removing the air filter plate.

1. Unscrew the screw in the center of the filter plate sufficiently to allow the plate to be removed. The screw is captive in the plate.
2. When the filter plate has been removed, the filter element can be changed. Replace the filter plate after changing the filter element.

Connection

All connections are made on the side panel of the Touch Display unit. The connector layout is shown in Figure 8.

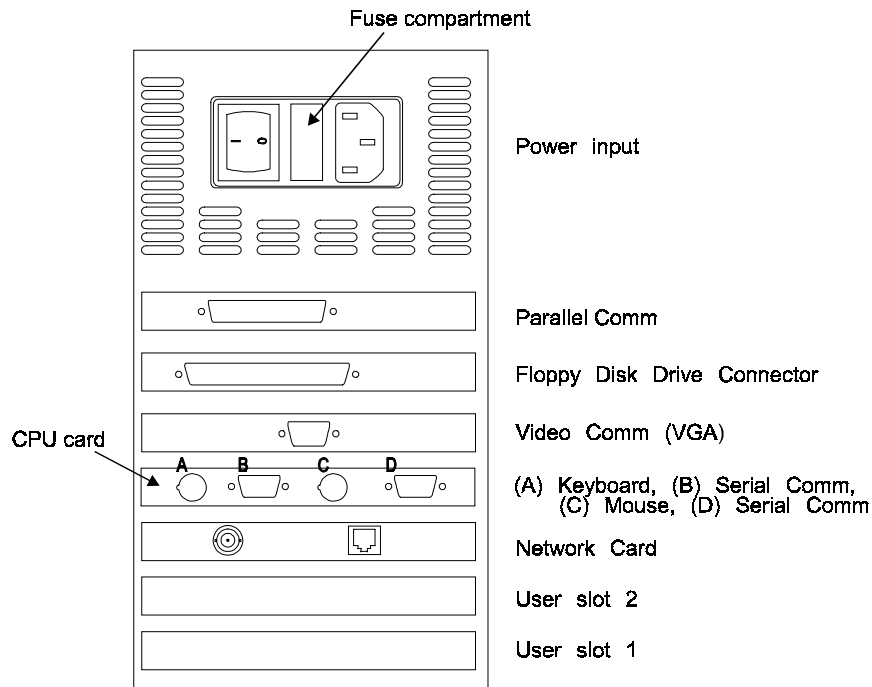

Note: The CPU card must always occupy the card position as shown above.

Figure 8. Touch Display Connectors

Table 4. Connector Listing

Card Slot (from top)	Type	Function
none	3-prong AC power receptacle	Power input
1	25-pin, female, D-type	Parallel communications
2	37-pin, female, D-type	Floppy disk drive connection
3	15-pin, female high density D-type	VGA CRT output
4A	6-pin, mini DIN	Keyboard connection
4B	9-pin, male, D-type	Serial communications
4C	6-pin mini DIN	Mouse connection
4D	9-pin, male, D-type	Serial communications
5	Coaxial	Ethernet communications
5	RJ45 (10BaseT)	Ethernet communications

AC Power Input

The power input connector is a standard CEE22 type. A power cable is supplied with the Touch Display unit.

The power supply is auto-ranging, therefore no configuration is needed to change the unit between 110 volt AC and 240 volt AC operation. Check that the fuse is of the correct rating for the supply voltage.

The panel mounted power input connector houses a 5 x 20mm fuse in a compartment adjacent to the input socket. The fuse-holder can be accessed only when the power lead is withdrawn.

Fuse value

- 2 amps for 240 volt working
- 4 amps for 110 volt working.

Keyboard

No keyboard is supplied with the Touch Display product. A PC AT keyboard is required to configure the application software. After configuration, the Touch Display can be operated without a keyboard by using the built-in touch screen.

The keyboard connector is a standard 6-pin DIN type, female connector.

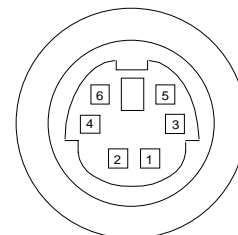

Serial Communication Cables

COM1 and COM2 Pin Assignments

1	DCD
2	Rx
3	Tx
4	DTR
5	Gnd
6	DSR
7	RTS
8	CTS
9	RI

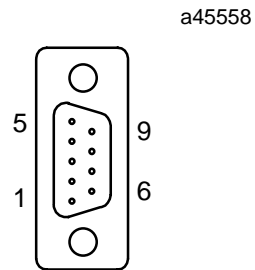

Serial communication cables for COM1 and COM2 should be correctly terminated.

- Typically COM1 is used for communications to the PLC and COM2 is used for Host Communications to another device or for a serial mouse.
- To ensure that the installation meets the EMC radiation specification, the serial cables must comply with the following requirements:
 - The cables must be of the shielded type.
 - The D-type connector covers must provide EMC shielding (e.g. metallized plastic or die cast metal covers).
 - The cables must be terminated with 360 degree termination of the shield, as illustrated below.

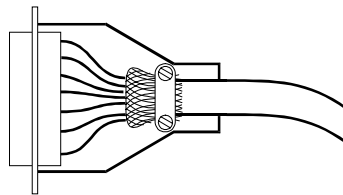

Correct termination

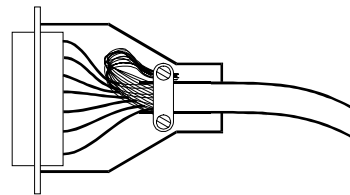

Incorrect termination

Printer Port LPT1 (Parallel Port)

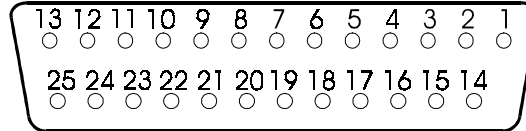

LPT1 Pin Assignments

1	Strobe	10	Acknowledge
2	Data Bit 0	11	Busy
3	Data Bit 1	12	Paper End
4	Data Bit 2	13	Select Out
5	Data Bit 3	14	Auto Feed XT
6	Data Bit 4	15	Error
7	Data Bit 5	16	Initialize Printer
8	Data Bit 6	17	Select In (From Printer)
9	Data Bit 7	18 to 25	Ground

Floppy Disk Drive Interface

The 3.5 inch floppy disk drive interface is factory set to Drive A. Connection is via a 37-pin female D-type connector mounted on the side of the Touch Display unit.

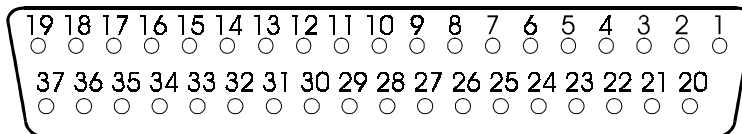

Disk Drive Interface Pin Assignments

1 to 18	Ground		28	DIR	Direction
19	+5 VDC.		29	STEP	Step Pulse
20	RWC/RPM	RPM Low	30	WD	Write Data (to floppy)
21	No connection		31	WE	Write Enable
22	No connection		32	TR0	Track 0
23	IDX	Index	33	WRPRT	Write Protected
24	MO1	Motor Enable 1	34	RDD	Read Data (from floppy disk)
25	DS0	Drive Select 0	35	HS	Head Select
26	DS1	Drive Select 1	36	DCHNG	Disk Change
27	MO0	Motor Enable 0	37	Vcc	+5 V

Initial Startup

When you first power up your system, you will need to attach a standard PS/2-type keyboard to the external keyboard port on the Display Station. When the system starts up, you will be required to enter the Product ID from the Windows 95 Certificate of Authenticity and other data to set up your system.

Also, most configuration activities that you perform on a Touch Display system can be more easily completed using a keyboard or may require a keyboard.

Powering Up the Touch Display Unit

Caution

Do not connect or disconnect external devices, such as a printer or an external floppy drive, while the unit is powered. Failure to observe this precaution could result in damage to the equipment.

The power switch is located on the side of the Touch Display unit next to the input power connector. To power up to unit, set the rocker switch to the | position.

During power up, the processor will run its normal diagnostic checks and indicate the presence of any errors either with a screen prompt or with warning beeps.

Setting Up Windows 95 Systems (IC752CTD400)

Before you get started you need a PS/2 Keyboard.

1. Plug in the floppy disk assembly, keyboard, and power cord.
2. Power on the unit. The Windows 95 Setup screen will appear.
3. Select your Regional Settings. Touch the Next button.
4. Select your Keyboard Layout. Touch the Next button.
5. Type your name.
6. Press the TAB key and type your company name
7. Press ENTER.
8. Read the license agreement
9. Touch your choice.
10. Touch Next.
11. Enter the Windows 95 Certificate of Authenticity number found on the front of your Windows 95 manual. Press ENTER.

-
12. Touch the Finish button. (Although the network card supports Plug & Play mode, this feature has been disabled due to hardware conflict of non-Plug & Play devices. Please refer to “Installing Network Driver on Microsoft Windows 95 Systems”.)
 13. Windows 95 will go through setup.
 14. When prompted for Date/Time Properties, use your left and right arrow key to switch the time zone to your time zone. Press ENTER.
 15. If you have a printer connected, click Next and select your printer model type. If not, touch the Cancel button. The Welcome to Windows 95 window will appear.
 16. Click Close for the Welcome to Windows 95 window.

Installing Network Driver on Microsoft Windows 95 Systems (IC752CTD400)

Although the network card supports Plug & Play mode, this feature has been disabled due to hardware conflict of non-Plug & Play devices. It is recommended that the network card use the NE2000 compatible driver instead of the Plug & Play driver provided on the Ethernet Card diskette. To set up your network please follow the steps below.

1. Click the Start icon, click Settings, and Control Panel.
2. In the Control Panel window, double click the Network icon. The Network dialog box will appear.
3. In the Network dialog box, click the Add button. The Select Network Component Type dialog box will appear.
4. Click the Adapter icon. The Select Network Adapters dialog box will appear.
5. In the list of Manufacturers, select Novell/Anthem. Press the TAB key to go to the Network Adapters list. Choose NE2000 Compatible. Click the OK button or press ENTER.
6. In the Network Configuration dialog box, select the NE2000 Compatible line and then click the Properties button.
7. Click the Resources tab. Change the IRQ to 9. Change the I/O address range to 340 — 35F. Click the OK button. (The IRQ setting may change to 9/2.)
8. Click the OK button in the Network dialog box. The system will copy the necessary files and prompt you to restart your computer. To acquire network service, restart the computer by clicking OK or pressing ENTER.

Configuring the Touch Display to Run on a Microsoft Network

Before setting up your new CIMPLICITY Display Station up for the network, you should consult with your network administrator. Duplicate TCP/IP addresses and duplicate computer names on the same network cause network problems. Each computer on a network must have a unique name and TCP/IP address.

1. Click the Start icon, then click Settings and Control Panel.
2. In the Control Panel window, double click the Network icon. The Network dialog box will appear.
3. In the Network dialog box, click the Add button.
4. In the Select Network Component Type dialog box, select the Client option. Click Add.
5. Select Microsoft as the manufacturer and Client for Microsoft Networks. Click the OK button.
6. After your system has restarted, go into the Control Panel and double click on the Network icon.
7. In the Network dialog box, you will see two tabs in addition to Configuration. Click the Identification tab. You will need to type in your Computer name, Workgroup name, and Computer Description.

Note

Computer names must be less than or equal to ten characters to run CIMPLICITY software. Each computer on a network must have a unique name.

In Windows 95 systems, for Viewers and HMIs to be able to browse remote nodes, the local computer name must be entered into the `/WINDOWS.000/HOSTS` file.

8. To allow sharing,
 - A. Go to the Configuration tab and click the File and Print Sharing button. The File and Print Sharing dialog box will appear.
 - B. Check the File and Print Sharing options that you want and click OK.
9. To add the TCP/IP protocol,
 - A. go to the Configuration tab and click the Add button. The Select Network Component dialog box will appear.
 - B. Click the Protocol icon and click the Add button. The Select Network Protocol dialog box will appear.
 - C. In the Manufacturer list, select Microsoft. In the Protocol list, select TCP/IP. Click OK.
10. When you have finished setting up the Network, click OK in the Network dialog box. Click Yes to reboot your system now.

Setting up Windows NT Systems (IC752CTD450)

Before you get started you will need to connect a PS/2 keyboard to the Display Station.

1. Plug in the floppy, keyboard, and power cord.
2. Power on the unit.
3. Read license agreement
4. TAB to your choice and press ENTER.
5. Press Enter to start the Windows NT Setup.
6. Type your name
7. Press the TAB key and type your company name.
8. Press Enter
9. Enter your Windows NT Authentication number found on your Windows NT manual. You will need to use the TAB key to get to each number field. If correct, press ENTER.
10. Enter a Computer name. This name should be unique to other computers on the same network. Press ENTER.

Note

Your system has been set up to enable autologon. Autologon allows the system to boot into Windows NT without your having to use a keyboard to press CTL-ALT-DEL.

11. You will be prompted for a password.

Note

The password is case sensitive. You must use lowercase **ge** for the password.

- To use the autologon feature, type **ge** for the password. Press the TAB key and type **ge** in the Confirm Password box. Press ENTER.
 - To skip the password, press ENTER
 - To assign a password, type in a password, press the TAB key, and type the password in the Confirm Password box. Press ENTER.
12. Press ENTER to continue with Windows NT Setup.
 13. Refer to the network setting for your product part number to set up the network.
 14. After completing the network setup the system will copy files over and finalize its setup.
 15. At the end you will be ask to reboot the system. Press ENTER.

Installing Network Driver on Microsoft Windows NT Systems (IC752CTD450)

1. During the initial setup of Windows NT, the system will display a screen with the following options already selected:
 - “This computer will participate on a network.”
 - “Wired to a network:”.Press ENTER to accept the default
2. Press the TAB key three times to select “Select from list...” option. Press ENTER.
3. Page down (approximately 29 times) to select “Novell NE2000 Compatible Adapter.” Press ENTER.
4. You should see your selection on the next screen. If okay, press ENTER.
5. If necessary, consult your network engineer to select the Network protocols and TCP/IP address selection. In most cases, you will only need, the TCP/IP protocol, but it does not hurt to enable all the protocols.
6. The Novell NE2000 Compatible Network Card Setup dialog box will pop up. Use the TAB key and up and down arrow keys to select IRQ2 and I/O Address 340. Press ENTER.
7. The Novell NE2000 Adapter Bus Location dialog box will appear. Press ENTER.
8. In most cases, you will enter a specific unique IP address and not enable the DHCP option.
9. Follow the menus as displayed for finalizing your network setup.

Login Recommendation

If you enter **ge** as your Administrator password, your CIMPLICITY Display Station will automatically log on as Administrator.

Log onto the system as Administrator when you power up the system. Doing so eliminates the requirement to log on to CIMPLICITY when you run the CIMPLICITY Demo or any other CIMPLICITY project that includes a user named Administrator. All CIMPLICITY projects are configured with an Administrator user by default.

Registering Your CIMPLICITY Software

All Display Stations are licensed to run CIMPLICITY software. You will need to register your CIMPLICITY software by following the steps below. Licenses have been loaded for CIMPLICITY HMI Base, Trending, TCP/IP Communications, and Series 90 SNP Communications numbers can be found in the license packs provided. If you purchase additional product options to run on the Display Station, you will need to contact GE Fanuc to update the system licensing.

1. Click Start, Programs, CIMPLICITY, HMI, Registration.
2. Click Next for new User.
3. Read the License Agreement and select Yes if you agree.
4. Fill in the User Information.
5. Click Next
6. Open your CIMPLICITY software box and find your license packs. Open each license pack and type the serial numbers in the fields provided.
7. Call the CIMPLICITY phone number that appears on the screen.

Faxes and phone calls will be processed between 8 AM and 5 PM Eastern time, Monday through Friday, except for regularly scheduled holidays. Faxes and calls received after hours, on weekends, or holidays will be processed as soon as possible on the following business day.

When you phone, please be prepared to provide GE Fanuc with the following information:

- Your User information
- CIMPLICITY serial numbers
- The System Key Code generated during the registration procedure

Note

When it is installed without the authorization code, you can run the software as a fully functional system in two-hour increments.

Installing Application Software

The Windows operating system and CIMPLICITY HMI software is loaded onto the Touch Display unit at manufacture. If it is necessary to reload software, follow the instructions in the documentation supplied with the software. The following sections give tips for customizing the software for the Touch Display platform.

External CD-ROM Drive

A driver, BP32DRV, is factory-installed to allow the Micro Solutions Backpack™ External CD-ROM Drive to be used for loading software. To enable this driver on units with Windows NT, select Devices under Control Panel, select BP32DRV, and change Startup setting to System. Close the Control Panel, shut down, and connect the drive to the parallel port. Restart the system and open Windows NT Explorer. The CD-ROM should appear as D:. When finished, the driver can be set to Disabled again. For units using Windows 95, simply shut down, connect the drive, and restart.

Touch Screen Driver for Windows

Operation of the touch screen surround requires the software driver T5driver for Windows 95 .or TNdriver for Windows NT.

The integral touch-surround of the Touch Display unit is internally connected to the serial port on the backplane. Parameters must be given to the software driver to match the hardware settings (refer to Touch-screen Port Address, page 8). The factory default settings are:

COM Port	= CUSTOM
Address	= 310 hexadecimal
Interrupt	= 5

These parameters are written into the Windows SYSTEM.INI file by the touch screen software driver setup utility. T5driver or TNdriver will be installed, configured and calibrated at manufacture.

Note

When the above parameters are entered using TNSetup, a message is given that a line should be added to AUTOEXEC.BAT, such as:

```
C:\WINDOWS\TBBIOS 3 310
```

This message can be ignored.

Shutting Down the Computer

Caution

To avoid damaging files, always shut down Windows software before removing power from your Display Station product.

To shut down Windows 95 or Windows NT software, select Shut Down from the Start menu.

System Operation

External Mouse

The touch screen and PS/2 mouse will work simultaneously if the mouse is 100% Microsoft or IBM PS/2 compatible. Because Windows can load only one mouse driver at a time, it is not possible to provide simultaneous support for a mouse that requires its own specific Windows driver.

CIMPLICITY Software

For detailed software operating instructions, refer to the following documentation.

GFK-1189	<i>CIMPLICITY® HMI for Windows NT™ and Windows® 95 Important Product Information</i>
GFK-1180	<i>CIMPLICITY® HMI for Windows NT™/CIMPLICITY HMI for Windows® 95/CIMPLICITY Server for Windows NT™ Base System User Manual</i>
GFK-1181	<i>CIMPLICITY® HMI for Windows NT™/CIMPLICITY HMI for Windows® 95/CIMPLICITY Server for Windows NT™ Device Communications Manual</i>
GFK-1396	<i>CIMPLICITY® HMI for Windows NT and Windows 95 CimEdit Operation Manual</i>

Communications

For information on the hardware setup for device communications, refer to *CIMPLICITY® HMI for Windows NT™/CIMPLICITY HMI for Windows® 95/CIMPLICITY Server for Windows NT™ Device Communications Manual*, GFK-1181.

Your CIMPLICITY Touch Display has been configured with networking components that enable you to establish new networks or connect to existing networks easily. If you intend to use Microsoft NetBEUI, TCP/IP, or Direct Cable Connection, some minimal setup changes are required before you can use the system for network applications. In both Windows 95 and Windows NT systems, these settings are changed using the Network application in the Control Panel program group.

BIOS Settings

It is normally not necessary to change the hardware configuration settings in the CMOS memory. If settings become corrupted, follow the procedures here to reload the factory configuration.

Enter the CMOS Setup mode by pressing the DEL key when prompted during the computer power-up sequence. A screen will appear offering several options for changing settings, restoring default settings, and other functions. Follow these instructions to restore the factory configuration.

1. Select the Load BIOS Defaults option. Then, select the Save CMOS settings option. You will be prompted to exit. *Do not* exit at this time.

2. Go into Standard CMOS Setup and make the following selections:

Primary HDD master	AUTO, LBA mode
Secondary HDD master and slave	NONE
Primary HDD slave	NONE
Drive A	1.44 MB 3.5" drive
Drive B	NONE
Halt on Errors	All, but keyboard

Exit Standard CMOS Setup.

3. Go into BIOS Features Setup and make the following selections:

Bootup Floppy Seek	No
Boot Search Order	A,C

Exit BIOS Features Setup.

4. Go into Chipset Features Setup. Set parallel port to ECP+EPP. Exit Chipset Features Setup.

5. Select Save and Exit Setup. The startup sequence should begin now.

The system is now configured with factory CMOS settings.

Interrupt Requests and I/O Assignments

Caution

Each hardware resource in the system must be assigned a unique interrupt request (IRQ) number and an I/O address range. If these settings overlap, the system will not function properly.

Below is a list of the factory-set IRQs and addresses used in the system, and whether they are available for add-in cards. Problems can be avoided if add-on devices use the IRQs and address ranges labeled "Available". If necessary, the touch screen and network card settings can be changed to accommodate new hardware that will only work at the settings used by these devices. The directions for changing the touch screen settings are provided in this document. Utilities for changing network card settings are in the C:\NWCARD directory.

Table 5. IRQ Table

IRQ2/9	Network Adapter
IRQ3	COM 2
IRQ4	COM 1
IRQ5	Touch Screen Controller
IRQ6	Reserved
IRQ7	Reserved
IRQ8	Reserved
IRQ10	Available
IRQ11	Available
IRQ12	Reserved
IRQ13	Reserved
IRQ14	Reserved
IRQ15	Available

Table 6. I/O Port Range Table

000-1FF	Reserved
200-27F	Available
280-2FF	Reserved
300-31F	Touch Screen Controller
320-33F	Available
340-377	Network Adapter
378-3DF	Reserved
3E0-3EF	Available
3F0-3FF	Reserved

Diagnostics and Troubleshooting

This section consists of “Self-Test Diagnostics,” “Troubleshooting,” and “Corrective Actions.” “Self-Test Diagnostics,” describes how to respond to errors that could be detected by the automatic self test that is performed each time the Display Station powers up. “Troubleshooting” contains tables of symptoms, their possible causes, and recommended corrective actions. “Corrective Actions” contains detailed procedures that are too lengthy to include in the Troubleshooting tables.

Self-Test Diagnostics

The computer automatically performs self-test diagnostics each time it is powered up. The self-test consists of a series of checks that verify correct performance of the computer hardware. When the self-test is being performed, you will see the message XXXX KB OK displayed on the screen, where XXXX is a number that increases until it matches the amount of usable memory.

System Test and Initialization

These routines test and initialize board hardware. If the routines encounter an error during the tests, you will see an error message on the screen. There are two kinds of errors: fatal and non-fatal. If a non-fatal error occurs, the system can usually continue the boot up sequence. Non-fatal error messages usually appear on the screen with the following instruction:

press <F1> to RESUME

Write down the message and press the **F1** key to continue the bootstrap sequence.

System Configuration Verification

These routines check the current system configuration against the values stored in the CMOS memory. If they don't match, the program will generate an error message. To correct this condition, you will need to run the BIOS setup program and correct the configuration information in memory. (Refer to page 24.)

There are three situations in which you might need to change the CMOS settings:

1. You are starting your system for the first time.
2. You have changed the hardware attached to your system.
3. The CMOS memory had lost power and the configuration information has been erased. If this has happened, call GE Fanuc's CIMPPLICITY hotline.

Troubleshooting

Powerup

Symptom	Possible Causes	Solution
For Windows NT systems only: The following error message appears: The system could not log you on. Make sure your User name and Domain are correct ...	You did not type ge for the password during initial setup.	Set the logon password to ge . For instructions, see "Auto Logon Error Message" on page 33.
Display Station does not power up.	Power not on (PWR indicator not lighted or display completely dark).	Make sure that Display Station is plugged in. Make sure that power source is functioning properly.
Display is blank (PWR indicator is lighted).	See "Display" on page 28.	See "Display" on page 28.
Non-System disk or disk error message displayed.	Disk in floppy disk drive.	Remove floppy disk and then reboot or power cycle.
Safe Recovery Error message displayed.	Occurs on initial power up if the unit is accidentally turned off without first shutting down the Windows 95 software.	The Display Station will power up normally.
Memory count during powerup self-test is incorrect.	Optional SIMM is installed incorrectly or is incompatible with the Display Station CPU.	Make sure that the appropriate memory is installed correctly.
CMOS checksum error – Defaults loaded CMOS battery failed message displayed.	CMOS battery failure.	Note: This battery has a lifetime of up to 10 years under normal operating conditions. The battery is not field replaceable. For more information, see "CMOS Checksum Error" on page 33.
A screen appears just after powerup, or just after reset, which has the title "CMOS Setup Utility."	The DEL key has been accidentally pressed.	Cycle power again. The Display Station will power up normally.
The Display Station reset even though the power was not interrupted.	The CTRL-ALT-DEL keys were pressed twice at the same time.	This should never be done, unless you are attempting to reset the Display Station.
A:> appears instead of software.	A system floppy disk is inserted.	Remove disk and cycle power.

Display

Symptom	Possible Causes	Solution
Characters are dim.	Computer screen is in direct light.	Change lighting or adjust contrast.
Display is blank (PWR indicator is lighted).	Screen has overheated.	If Display Station is in direct sunlight, move it and allow it to cool.
	Display Station is set up for invalid video mode.	Reboot. Windows NT models: select VGA Mode Windows 95 models: press F8 when "Starting Windows 95" appears, then select Safe Mode. If Windows is now displayed, go into Control Panel, Display Settings, and change settings to the correct video driver and mode. Contact GE Fanuc's CIMPPLICITY hotline for more information.
	Screen saver is active.	Touch the touch screen, or a key on the keypad.

Memory

Symptom	Possible Causes	Solution
Memory count during powerup self-test is incorrect.	Optional SIMM is installed incorrectly or is incompatible with the Display Station CPU.	Make sure that the appropriate memory is installed correctly.
Out of Memory message is displayed or insufficient memory error occurs during operation.	System ran out of memory for the application.	Check the memory requirements for the application. (Refer to the application documentation.) Install additional memory.
	Too many terminate and stay resident (TSR) programs running.	Modify the startup folder to use only those TSR applications that are really needed.

Touch Screen

Note

Operating temperature can affect touch screen calibration. If touch screen operation is slightly off, recalibrate it by running calibration from the Touch Screen icon in Control Panel.

Symptom	Possible Causes	Solution
Cursor does not respond at all to touch.	Touch screen disabled.	Make sure documented default touch screen settings are selected.
	Touch screen driver accidentally deleted.	Reinstall touch screen driver
	System is busy.	Press CTRL-ALT-DELETE once to view task list.
Cursor moves but does not follow your touch accurately.	Touch screen not calibrated properly.	Run calibration from ELO Touch Screen in Control Panel (see page 33).
Touch screen responds erratically to touch; cursor might not be visible.	Display Station is connected to a serial mouse. Touch screen settings are incorrect.	Disconnect serial mouse, connect a PS/2 mouse, and reboot. Refer to page 22 for settings.

External PS/2 Mouse

Symptom	Possible Causes	Solution
Cursor does not respond to mouse movement	Mouse not plugged in.	Plug mouse into mouse port on Display Station and reboot.
	The type of mouse is not supported.	Use a PS/2 mouse.
	System is busy.	Press CTRL-ALT-DELETE to view task list.
	Mouse not detected.	Restart Display Station product with external mouse connected.

Keyboard

Symptom	Possible Causes	Solution
External keyboard locks up	The type of keyboard is not supported.	Use a Key Tronic keyboard. (Most keyboards will work. However, we recommend a keyboard manufactured by Key Tronic.)
	Keyboard not plugged into keyboard port on Display Station.	Plug keyboard in.
	System is busy.	Press CTRL-ALT-DELETE to view task list.

Communications

PLC/CPU Connection

Symptom	Possible Causes	Solution
CIMPLICITY does not communicate with a PLC that has been autoconfigured (AUTOCONFIG/DEFAULT/I/O error).	The system is attempting to communicate with a 90-30 PLC using the SNP driver and a CIMPLICITY project.	<ol style="list-style-type: none"> 1. With the PLC powered up and connected to the Display Station, establish communication between the Display Station and PLC via the 90-30 SNP driver. 2. Using a Hand-Held Programmer, toggle the Default I/O (Enable or Disable) configuration parameter for the CPU. Communications between the Display Station and the PLC will be stopped. (Communications are stopped when you toggle from Enable to Disable, or vice versa.) 3. Power cycle the PLC.
Communications between the host computer and the controller are unsuccessful.	COM port not configured in system.	Verify that the COM port is configured in the system.
	Cabling between computer and controller.	Verify that the cable between the computer and the controller is correctly wired.
	Baud rate and parity configured incorrectly.	Verify that the baud rate and parity on the computer are consistent with those on the controller.
	Wrong address.	Verify that the slave address is correct.

MODBUS RTU Communications

Symptom	Possible Causes	Solution
Communications between the host computer and the controller are unsuccessful.	COM port not configured in system.	Verify that the COM port is configured in the system.
	Cabling between computer and controller.	Verify that the cable between the computer and the controller is correctly wired.
	Baud rate and parity configured incorrectly.	Verify that the baud rate and parity on the computer are consistent with those on the controller.
	MODBUS port not configured for RTU communications.	Verify that the controller's MODBUS port is configured for RTU communications.
	Wrong address.	Verify that the slave address is correct.

Network Communications

Symptom	Possible Causes	Solution
Conflicts on network.	IP Address not unique.	Change the IP address to a unique address. (Contact your system administrator if this or other settings need to be changed.)

Printing

Symptom	Possible Causes	Solution
Printer will not turn on.	Cables not connected properly. Printer power cord not plugged in.	Ensure that the cables are properly connected and that the power cord is connected to the electrical outlet.
Printer will not print.	Printer is not turned on.	Turn on the printer
	Printer is not online.	Set the printer to online.
	The device drivers for your application are not installed.	Install the correct printer drivers for your application in Windows.
	Printer that is set up for a network is not connected to the network.	Connect the printer to the network.
	Printer cable is too long, unshielded, or defective.	Replace the cable.
Printer is offline.	Paper tray is empty.	Fill the paper tray with paper. Set printer to online.
Printer prints garbled information.	Correct printer drivers not installed.	Install the correct printer driver.
	Cable is not connected properly.	Ensure that the printer cable is connected properly to the computer.
	Problem specific to printer.	Run a printer self-test. Refer to the documentation provided with your printer for instructions. If the self-test fails, the problem is printer-specific. The printing section of the software documentation and in Windows online Help may also be helpful.

Corrective Actions

Auto Logon Error Message

All Windows NT CIMPLICITY Display Station products have the auto logon feature enabled with **ge** as the password. This feature eliminates the need for a keyboard to type CTRL-ALT-DEL and enter a password. If, during initial setup, you do not type **ge** as your password, you will receive the following error message each time the system is booted.

Logon Message

The system could not log you on. Make sure your User name and Domain are correct, then type your password again. Letters in the password must be typed using the correct case. Make sure that Caps Lock is not accidentally on.

This message means that auto logon could not occur because the password is something other than **ge**. If you want to enable auto logon and avoid the error message, complete the following instructions:

1. Click Start, Programs, Administrative Tools, and User Manager.
2. If Administrator is highlighted, click User in the top task bar and select Properties.
3. In the Password and Confirm Password fields, type **ge**. Click OK.
4. Press ALT-F4 to close the User Window.

If you wish to log on manually, click OK to the error message and log on normally. To eliminate the error message for future manual logons, you will need to edit the registry on your Display Station product. For details on editing the registry, you will need to call the CIMPLICITY hotline.

Calibrating the Touch Screen

During the first time powerup of the Display Station, you might need to calibrate the touch screen. To do this, connect an external PS/2 mouse or a PC AT keyboard and complete the following steps:

1. Click the Start button. (If you are using a keyboard, press CTRL-ESC to bring up the Start menu.)
2. Go to Settings and select Control Panel.
3. Select the ELO Touchscreen icon.
4. Press Enter to run the calibration. Follow the instructions presented by the calibration program.

CMOS Checksum Error

If the CMOS battery has failed, the following error messages will be displayed on the screen:

CMOS checksum error - Defaults loaded

CMOS battery failed

If you see the above message, you can still operate the Display Station by pressing the DELETE key and manually setting up the system. (You will need to set up the computer each time the system is powered up.) For setup parameters, refer to “BIOS Settings.”

This battery has a lifetime of up to 10 years under normal operating conditions. The battery is not field replaceable. The Display Station unit must be returned to GE Fanuc to correct the problem.

Frequently Asked Questions

Hardware FAQs

My touch screen isn't working. What should I do?

Ensure that the Touch Screen settings (in the Control Panel, double click the Touch Screen icon) are set as described in "Touch Screen Driver for Windows" on page 22.

Where is the right mouse button when using the touch screen?

This feature is not supported on the touch screen.

Can I use an external mouse and the touch screen at the same time?

Yes. A external PS/2 mouse can be used with the touch screen if the system is rebooted after it is connected. True for these models?

How do I clean the touch screen?

Touch screens can be wiped down with a clean cloth or paper towel dampened with water or glass cleaner.

How do I upgrade the Touch Display RAM?

All Touch Display products have at least 32MB of RAM installed in the factory. You can order additional RAM with your initial order or upgrade at a later time. Currently, you can upgrade to 64MB (IC752RAM032) or 128MB (IC752RAM128) of RAM.

My Touch Display unit has a 1.2GB hard drive. How can I get a larger drive?

Hard drives must be installed in the factory to retain the Touch Display warranty. An upgrade to a 2GB drive is available. To upgrade your drive, send the Touch Display product to the factory and order the upgrade part number (IC752HDD200). Touch Display products can be ordered initially to include this upgrade.

Can I upgrade the CPU in my Touch Display?

All Touch Display products contain at least Pentium 133 CPUs. Upgrades to Pentium 200 are available. All CPU upgrades must be done in the factory to retain the warranty.

Software FAQs

What HMI software comes preloaded on the Touch Display product?

Beginning in mid-February 1997, all units come preloaded with the full point count version of HMI software. You can get either Windows '95 or Windows NT operating system with the development/runtime packages. All Touch Display products come with server packages but can be operated as viewers.

Will Display Station products with limited point counts be offered?

There are no plans for this at this time.

I am using the touch screen and would like to know if I can log on to an NT System without a keyboard. Can I do this?

All systems have autologon enable for Administrator with **ge** as the password. For details, see page 21.

To disable the screen logon message, refer to the CIMPPLICITY Web page at <http://www.cimplicityhmi.com/appnote/logon.htm>. The application note provided at this Web site describes how to create a default logon for the operating system that also acts as a logon for CIMPPLICITY so that you only need to turn on the machine to have CIMPPLICITY come up and be ready for use.

I heard that there is now a longer period that the software will run without authorization. What are the details?

You should go ahead and register your CIMPPLICITY software. The period of four days starts when CIMPPLICITY is first loaded. Your system will default to the two-hour limit because the four days will have expired.

Specifications

Features	
Microprocessor	Pentium 133 MHz
Math Coprocessor	built in
User memory	32 Mbyte
Operating System	Microsoft Windows 95 or Microsoft Windows NT
Hard Disk	1.2 Gbyte
ISA bus card slots	Six total. Two full length slots available for additional cards.
Total current available for sharing by up to two user cards	+5 VDC, 1.2 A approx. +12 VDC, 0.1 A approx. -12 VDC, 0.1 A approx.
Display	
Type	640 x 480 pixel Color TFT (thin film transistor) active matrix LCD
Area	211 x 159mm (8.31 x 6.26 inches)
Power Requirements	
AC Input	85 to 250 VAC, 110 W, Auto-ranging, 47 to 63 Hz
Fuse Rating	4 A (90 to 132 VAC) 2 A (180 to 250 VAC.)
Inrush Rating	17 A at 110 VAC, 34 A at 220 VAC
Ports	
Parallel Ports	One LPT1
Serial Ports	Two external RS232 ports: COM1 and COM2 Also CUSTOM COM (wired internally to touch-screen)
Keyboard Port	PS/2
Floppy Disk Interface	3.5 inch, 1.44 Mbyte via 37-pin D-type connector Configured as drive A:
Environmental	
Operating Temperature	Ambient working temperature range 0 to 40 °C
Relative Humidity	5 to 85% non-condensing
Drop Test	1 meter drop onto any face within packaging

A

- AC Input, 13
- Air filter, 11
- Audible warning, 16
- Auto Logon error message, 33
- Autologon, 19

B

- Backplane
 - reserved I/O address, 8
- BIOS settings, 24

C

- Calibrating the touch screen, 33
- Card Clamp, 7
- Catalog numbers
 - floppy disk drive
 - IC752FPY000, 3
 - Touch Display
 - IC752CTD400, 2
 - IC752CTD450, 2
- Catalog numbers, upgrades
 - IC752HDD200, 35
 - IC752RAM032, 35
 - IC752RAM128, 35
- CIMPLICITY software
 - operation, 23
- CMOS battery, 27, 34
- CMOS checksum error, 34
- CMOS settings, 26
- COM Ports connector, 14
- Communications, 23
 - troubleshooting, 30
- Configuring the network, 18
- Connection, 12
- Custom COM port addressing, 8

D

- Diagnostics
 - bootup sequence, 26
 - Self-test, 26
 - system configuration verification, 26
 - system test and initialization, 26
- Diagnostics and troubleshooting, 26
- Display
 - troubleshooting, 28
- Display Area, 37

E

- Environmental Specification, 37
- Error messages
 - AUTOCONFIG/DEFAULT I/O, 30, 31
 - CMOS checksum error, 27, 34
 - CMOS Setup Utility, 27
 - Disk Error, 27
 - Insufficient memory, 28
 - Logon, 27
 - non-fatal, 26
 - Non-system disk, 27
 - Out of Memory, 28
 - Safe Recovery, 27
- External mouse, 23

F

- Floppy disk drive
 - installing, 10
- Fuse rating, 37

H

- Hardware installation, 4

I

- Initial startup, 16
- Installing application software, 22
- Installing ISA-compatible cards, 7
- Installing Network Driver
 - Windows 95, 17
 - Windows NT, 20
- Interrupt requests and I/O assignments, 25

K

- Keyboard, 13
 - troubleshooting, 29

L

- Login recommendation, 21

M

- Memory
 - troubleshooting, 28
- MODBUS RTU communications
 - troubleshooting, 31
- Mounting Guidelines, 4

N

Network communications
troubleshooting, 31

P

PLC/CPU connection
troubleshooting, 30
Power Input, 13
Powering up, 16
Powerup
troubleshooting, 27
Printing
troubleshooting, 32
Product features, 2

R

Registering your CIMPLICITY software, 21
Reset
accidental, 27

S

Self-Test Diagnostics, 26
Serial Communication Cables, 14
Serial Mouse
troubleshooting, 29
Serial Port connector, 14
Setting Up Windows 95 systems, 16
Setting up Windows NT systems, 19
Shutting down the computer, 23
Specifications, 37
System Configuration Verification, 26
System operation, 23
System Test and Initialization, 26

T

Temperature, 37
effect on contrast setting, 28
effect on touch screen calibration, 29
Touch screen
calibrating, 33
I/O addressing, 8
IRQ assignments, 8
troubleshooting, 29
Troubleshooting
communications, 30
display, 28
keyboard, 29
memory, 28

MODBUS RTU communications, 31
network communications, 31
PLC/CPU connection, 30
powerup, 27
printing, 32
serial mouse, 29
touch screen, 29
TSRs, 28

W

Warning, audible, 16