

GFK-0487

[Buy GE Fanuc Series 90-30 NOW!](#)

GE Fanuc Manual Series 90-30

Series 90 PCM Development Software (PCOP)

1-800-360-6802

sales@pdfsupply.com



GE Fanuc Automation

Programmable Control Products

*Series 90™ PCM
Development Software
(PCOP)*

User's Manual

GFK0487C

May 1993

Warnings, Cautions, and Notes as Used in this Publication

Warning

Warning notices are used in this publication to emphasize that hazardous voltages, currents, temperatures, or other conditions that could cause personal injury exist in this equipment or may be associated with its use.

In situations where inattention could cause either personal injury or damage to equipment, a Warning notice is used.

Caution

Caution notices are used where equipment might be damaged if care is not taken.

Note

Notes merely call attention to information that is especially significant to understanding and operating the equipment.

This document is based on information available at the time of its publication. While efforts have been made to be accurate, the information contained herein does not purport to cover all details or variations in hardware or software, nor to provide for every possible contingency in connection with installation, operation, or maintenance. Features may be described herein which are not present in all hardware and software systems. GE Fanuc Automation assumes no obligation of notice to holders of this document with respect to changes subsequently made.

GE Fanuc Automation makes no representation or warranty, expressed, implied, or statutory with respect to, and assumes no responsibility for the accuracy, completeness, sufficiency, or usefulness of the information contained herein. No warranties of merchantability or fitness for purpose shall apply.

The following are trademarks of GE Fanuc Automation North America, Inc.

Alam Master	CIMSTAR	Helpmate	PROMACRO	Series Six
CIMPLICITY	GENet	Logicmaster	Series One	Series 90
CIMPLICITY 90-ADS	Genius	Modelmaster	Series Three	VuMaster
CIMPLICITY PowerTRAC	Genius PowerTRAC	ProLoop	Series Five	Workmaster

The Programmable Coprocessor Module (PCM), from GE Fanuc Automation North America, Inc., is a high-performance microcomputer designed to perform coprocessor functions in a Series 90™ PLC system. It combines the function of the Communications Module (CCM) and the ASCII/BASIC Module (ABM), used on the Series Six™ programmable logic controller (PLC), into a single module with significantly greater capacity and performance than that of the ASCII/BASIC Module.

Content of this Manual

This manual contains the following chapters and appendixes:

Chapter 1. Introduction: provides a brief introduction to the PCM development software, referred to as PCOP.

Chapter 2. Installing the PCM Software: describes how to install PCOP on the hard disk of your computer.

Chapter 3. Using PCOP to Program the PCM: describes how to use PCOP functions for configuration editing, programming, and running MegaBasic; loading and saving files; and other status and control functions.

Chapter 4. Using PCOP to Configure the PCM: describes how to use the configuration editor and the configuration data used to configure the PCM.

Chapter 5. Using PCOP in Expert Mode: describes how to use PCOP commands instead of the menu function softkeys.

Appendix A. PCOP Menu Structure: diagrams the PCOP menu structure and available software function keys.

Appendix B. Configuration Data: lists the assigned values and default value for each field on the configuration data records.

Appendix C. PCOP File Descriptions: lists the files placed on the PCM programmer's hard disk during the INSTALL procedure.

Appendix D. CONFIG.SYS File: describes how to edit a CONFIG.SYS file using the EDLIN line editor. For more complete information on using EDLIN commands and features, refer to your MS-DOS manual.

Related PCM Publications

For more information on PCM, refer to these publications:

Series 90™ Programmable Coprocessor Module and Support Software User's Manual (GFK-0255).

MegaBasic™ Programming Language Reference Manual (GFK-0256).

Programmable Coprocessor Module (PCM) Quick Reference Guide (GFK-0260).

PCM Development Software (PCOP) Quick Reference Guide (GFK-0657).

PCM Support Software (TERMF) Quick Reference Guide (GFK-0655).

Important Product Information for PCM Development Software (PCOP) (GFK-0352).

Important Product Information for PCM Support Software (TERMF) (GFK-0654).

Important Product Information for Series 90™ -70 PCM (GFK-0351).

Important Product Information for Series 90™ -30 PCM (GFK-0494).

Related Series 90 Publications

For more information on Series 90 programmable controllers, refer to these publications:

Series 90™ -70 Programmable Controller Installation Manual (GFK-0262).

Logicmaster™ 90-70 Programming Software User's Manual (GFK-0263).

Series 90™ -70 Programmable Controller Reference Manual (GFK-0265).

Series 90™ -30 Programmable Controller Installation Manual (GFK-0356).

Logicmaster™ 90 Series 90™ -30 and 90-20 Programming Software User's Manual (GFK-0466).

Series 90™ -30/90-20 Programmable Controllers Reference Manual (GFK-0467).

Series 90™ PLC Serial Communications User's Manual (GFK-0582).

Series Six™ Data Communications Manual (GEK-25364).

Series 90™ -70 Programmable Controller User's Guide to the Integration of Third Party VME Modules (GFK-0448).

We Welcome Your Comments and Suggestions

At GE Fanuc Automation, we strive to produce quality technical documentation. After you have used this manual, please take a few moments to complete and return the Reader's Comment Card located on the next page.

Linda R. McCoy
Sr. Technical Writer

Contents

Chapter 1	Introduction	1-1
	PCOP Functions	1-1
	Using PCOP to Configure the PCM	1-1
	Expert Mode	1-1
Chapter 2	Installing the PCM Software	2-1
	AUTOEXEC.BAT and CONFIG.SYS Files	2-1
	Installing PCOP	2-2
	Local Configuration File	2-6
	Connecting the PCM to the Programmer	2-7
	Diagnosing Serial Communication Problems	2-8
Chapter 3	Using PCOP to Program the PCM	3-1
	Section 1: PCOP Main Menu	3-2
	Invoking PCOP	3-2
	Initially Selecting/Creating a Program Folder	3-4
	Accessing the PCOP Main Menu	3-5
	Message Line	3-6
	Expert Mode	3-6
	Special Key Commands	3-7
	Key Summary	3-7
	Section 2: MegaBasic	3-8
	Accessing MegaBasic from PCOP	3-8
	Returning to PCOP	3-8
	Section 3: TERMF	3-9
	Invoking TERMF	3-9
	Returning to PCOP	3-9
	Section 4: Status Functions	3-10
	Error Display Screen	3-11
	Section 5: Control Functions	3-12
	Changing PCM Configuration Mode	3-13
	Executing a Task	3-14
	Stopping a Task	3-15
	Redefining the User LEDs	3-16
	Section 6: Program Folder Functions	3-18
	Creating/Selecting a Program Folder	3-19
	Deleting a Program Folder	3-20
	Backing up the Current Program Folder	3-21
	Restoring the Current Program Folder	3-22
	Clearing the Current Program Folder	3-23
	Listing the Contents of the Current Program Folder	3-24
	Copying a Program Folder	3-25

Contents

	Section 7: Program Utility Functions	3-26
	Saving a File from the PCM	3-28
	Loading a File to the PCM	3-29
	Directory of Files	3-30
	Deleting a File	3-31
	Deleting all Files on the PCM	3-32
	Using ADS Software	3-33
	Using the GDS Software	3-34
Chapter 4	Using PCOP to Configure the PCM	4-1
	Section 1: Configuration Editor	4-2
	Section 2: Edit Configuration Data Menu	4-3
	Saving a Configuration	4-5
	Screen Definitions	4-5
	Help Text	4-6
	Select Field	4-6
	Section 3: Standard Configuration Functions	4-7
	Default Configuration Data	4-7
	Hardware Configuration Data	4-8
	MegaBasic Interpreter Data	4-9
	Configuring a PCM for MegaBasic Programs	4-11
	CCM Configuration Data	4-12
	CCM Detail Data	4-15
	Serial Port Initialization Data	4-16
	Redefining the User LEDs	4-18
	Section 4: Advanced Configuration Functions	4-20
	Programmer Communications and File Server Data	4-20
	Commentary Data	4-22
	Read Configuration Data	4-23
	Write Configuration Data	4-24
Chapter 5	Using PCOP in Expert Mode	5-1
	ADS	5-2
	ADV	5-3
	BASIC	5-3
	CCM	5-3

Contents

CFG and CHE	5-4
CLEAR	5-4
COMMNT	5-5
CONFIG	5-5
CTL	5-5
DEFLT5	5-6
ERRORS	5-6
EXIT	5-6
FBAKUP	5-7
FCLEAR	5-7
FCOPY	5-8
FDEL	5-8
FDIR	5-9
FOLDER	5-9
FLOCK	5-9
FRESTR	5-10
FSEL	5-10
GDS	5-11
HELP	5-11
LED	5-12
LOAD	5-13
MB	5-14
MDEL	5-14
MDIR	5-15
PORTS	5-15
READ	5-15
RUN	5-16
SAVE	5-17
STASK	5-17
STATUS	5-18
STN	5-18
STOP	5-19
TERMF	5-19
USE	5-20
UTILTY	5-21
VERSION	5-21
WRITE	5-21
Appendix A PCOP Menu Structure	A-1
Appendix B Configuration Data	B-1
Appendix C PCOP File Descriptions	C-1
Appendix D CONFIG.SYS File	D-1

Contents

Figure A-1. PCOP Main Menu	A-1
Figure A-2. Edit Configuration Data	A-2

Contents

Table B-1. HWID Data	B-1
Table B-2. MegaBasic Interpreter Data	B-1
Table B-3. CCM Configuration Data	B-2
Table B-4. CCM Detail Data	B-2
Table B-5. Serial Port Initialization Data	B-3
Table B-6. LED Data	B-3
Table B-7. Edit Annotation Data	B-3
Table B-8. Programmer and File Server Data	B-4

Chapter 1

Introduction

This manual describes how to use the PCM development software (PCOP) to develop applications for the PCM. If the PCOP software is not yet installed, please refer to chapter 2 of this manual for instructions. For information on installing the PCM hardware and configuring the PCM using Logicmaster™ 90 programming software, please refer to the *Series 90 Programmable Coprocessor Module and Support Software User's Manual*, GFK-0255.

PCOP Functions

The PCM development software (PCOP) provides functions for configuration editing, programming and running MegaBasic; loading and saving files; and other status and control functions. PCOP also supports folder and file maintenance commands. All of these functions are accessed through the PCOP main menu, which is described in chapter 3, *Using PCOP to Program the PCM*.

Using PCOP to Configure the PCM

The PCM configuration editor allows you to edit the User Configuration Data (UCDF) that controls the PCM system configuration. Chapter 4, *Using PCOP to Configure the PCM*, describes how to access standard and advanced configuration functions through the Edit Configuration Data menu.

Expert Mode

Expert mode in PCOP reduces the number of keystrokes required for entering commands by providing shortcuts which may be used in place of the menu function softkeys. Refer to chapter 5, *Using PCOP in Expert Mode*, for information on this advanced programming feature of PCOP.

Chapter 2

Installing the PCM Software

In order to use the PCM development software (PCOP), it must be installed on the hard disk of the programmer. This chapter explains the INSTALL procedure.

Note

MS-DOS version 3.1, or higher, must already be installed on the hard disk of your MS-DOS based computer.

The installation procedure creates or updates the `\PCOP` and `\PCOP\BAT` subdirectories on the hard disk. The files that are installed in these directories are listed in appendix C, *PCOP File Descriptions*.

AUTOEXEC.BAT and CONFIG.SYS Files

Before starting to install the PCM software, check the content of the hard disk root directory (you can use the `DIR` function) to see whether there are already files named `CONFIG.SYS` and `AUTOEXEC.BAT` present. PCOP requires files with these names in the root directory.

Copies of both files are provided with the software; they can be installed automatically. If the hard disk already has these two files, you will be asked during the installation process whether to modify them; or, if you prefer, you can edit the existing files for use with the programmer software.

Caution

If Logicmaster 90 software has already been installed on your computer, it saved your original `AUTOEXEC.BAT` and `CONFIG.SYS` files as `AUTOEXEC.L90` and `CONFIG.L90`, respectively. When you install PCOP, the current versions of `AUTOEXEC.BAT` and `CONFIG.SYS` will be copied to `AUTOEXEC.L90` and `CONFIG.L90`, destroying the backup copies of your original files.

If you want to keep backup copies of your original files, copy them to files with different extensions:

```
copy AUTOEXEC.L90 AUTOEXEC.BAK
copy CONFIG.L90 CONFIG.BAK
```

The System Configuration file (**CONFIG.SYS**) is a text file which establishes the system configuration for the software. Different software packages use different system configuration files. For all PCM applications, the file must contain at least these two lines, which can be added by the **INSTALL** program:

```
Buffers=15
Files=20
```

You can use the **TYPE** command to check the content of an existing **CONFIG.SYS** file. For information about editing the **CONFIG.SYS** file, please refer to appendix D, *CONFIG.SYS File*.

The **AUTOEXEC.BAT** file must have the following added to the existing path:

```
(drive ID):\PCOP\BAT
```

where **(drive ID)** is the hard disk drive where PCOP is installed. This can be done by the **INSTALL** procedure. After you have checked the root directory, continue with the installation steps below.

Running Other Software with the CONFIG.SYS File for PCM

Other types of software may require different entries in the **CONFIG.SYS** file. It is not always possible to combine the requirements for multiple software packages in one **CONFIG.SYS** file. In that case, you must maintain multiple versions of the **CONFIG.SYS** file. Your MS-DOS manual contains more information about the **CONFIG.SYS** file.

Installing PCOP

The following procedure describes how to use the **INSTALL** procedure on a programmer with a hard disk.

1. If you have not already done so, start up the computer using MS-DOS.
2. Insert the PCOP diskette into the computer's diskette drive.
3. At the MS-DOS prompt, enter the designation of the diskette drive followed by a colon. For example, if the diskette is in drive A, type: **A:** and press the Enter key.
4. Begin the installation procedure by typing: **INSTALL** and pressing the Enter key.
5. Read the licensing agreement.

```
GE FANUC AUTOMATION
NORTH AMERICA, INC.

PCOP (c) INSTALLATION PROGRAM

COPYRIGHT (c) 1988 GE FANUC AUTOMATION NORTH AMERICA, INC.
Published in a limited, copyright sense and all rights,
including trade secret rights are reserved. Unauthorized
use of the information or program is strictly prohibited.

Installation of this software reaffirms acceptance of the
terms and conditions of the license agreement distributed
with this product.

PRESS <ENTER> TO CONTINUE INSTALLATION OR <ESC> TO EXIT
```

Pressing the Enter key after reading this screen means you agree to comply with the stated terms. Pressing the Escape key terminates INSTALL and returns you to MS-DOS.

If you press the Enter key, the screen displays:

```
The PCOP installation process involves transferring files from one
or more distribution diskettes to the hard disk on your computer.
Please enter the destination drive (or use the default drive that
is provided).

DESTINATION DRIVE (Hard disk) : C

Press <ENTER> to accept selection or <ESC> to exit
```

- 6. Specify the hard disk drive and press the Enter key, or just press the Enter key if the default is correct.
- 7. First, the INSTALL procedure creates the PCOP directory in the root directory of the specified drive.

- INSTALL checks the `AUTOEXEC.BAT` and `CONFIG.SYS` files in the root directory of the hard disk. These files must contain certain commands to ensure that the PCM software executes properly. If neither file exists, they are both created. If either file already exists, INSTALL will ask you if the file should be automatically updated.

```
Modifications must be made to the AUTOEXEC.BAT and CONFIG.SYS
files in order for the PCOP software to execute properly.
```

```
Should these changes be made automatically (Y/N) ? Y
```

If you want the `AUTOEXEC.BAT` and `CONFIG.SYS` files to be automatically modified, enter `Y` or press the Enter key. If there were already versions of those files in the root directory, they are renamed to `AUTOEXEC.L90` and `CONFIG.L90`, respectively.

Note

If your computer has more than one hard disk drive (or you have a large hard drive which is partitioned into two or more logical drives), and you install PCOP on a hard drive which is not the one your computer boots from, the `AUTOEXEC.BAT` and `CONFIG.SYS` files created by the install program will have no effect. For example, if your computer has a C: and D: drive and it boots from the C: drive, then installing PCOP on the D: drive will cause new `AUTOEXEC.BAT` and `CONFIG.SYS` files to be created on the D: drive. These will have no effect when your computer is powered up or reset.

In this case, you will need to modify the `AUTOEXEC.BAT` and `CONFIG.SYS` files on your boot drive manually. See appendix D, *CONFIG.SYS File*, for instructions on using the `EDLIN` utility to modify the `CONFIG.SYS` file. You can also use any text editor program which produces ASCII text files.

It is easy to identify your boot drive. It is the current drive (usually C:) after your computer completes its power-up initialization.

Caution

If Logicmaster 90 software has already been installed on your computer, it saved your original `AUTOEXEC.BAT` and `CONFIG.SYS` files as `AUTOEXEC.L90` and `CONFIG.L90`, respectively. When you install PCOP, the current versions of `AUTOEXEC.BAT` and `CONFIG.SYS` will be copied to `AUTOEXEC.L90` and `CONFIG.L90`, destroying the backup copies of your original files.

If you want to keep backup copies of your original files, copy them to files with different extensions:

```
copy AUTOEXEC.L90 AUTOEXEC.BAK
copy CONFIG.L90 CONFIG.BAK
```

If you already have **AUTOEXEC.BAT** and/or **CONFIG.SYS** files and plan to edit them, enter **N**. The following screen is displayed:

```
The following modifications must be made to the AUTOEXEC.BAT and
CONFIG.SYS files for the PCOP software to execute properly.

AUTOEXEC.BAT

Append the following subdirectory name to the existing path:

C:\PCOP\BAT

CONFIG.SYS

Modify the maximum number of files and buffers to at least:

BUFFERS=15
FILES=20

Delete the following line, if present:

DEVICE=GEXDISK.SYS

CONFIRM : Should these changes be made automatically (Y/N) ? N
```

- 9. If you change your mind and want **INSTALL** to update the **AUTOEXEC.BAT** and **CONFIG.SYS** files automatically, press **Y**. Otherwise, press **N** or the Enter key.
- 10. All the files needed for PCOP are now installed. **INSTALL** attempts to create two subdirectories on the hard disk and transfers the appropriate files to those subdirectories.

```
Installing PCOP on C:

If this is a first time installation, all necessary subdirectories
will be created and the files copied. If PCOP already exists, it
will be updated from the distribution diskette. This installation
will take several minutes.

WORKING
```

If the subdirectories already exist, any files in them are overwritten with the new files being installed.

11. After all the files have been transferred, the final installation screen is displayed:

```
The PCOP software installation is complete. Please remove the
distribution diskette from the floppy drive and reboot the
computer by pressing the key sequence CTRL-ALT-DEL. When the
DOS prompt returns, type PCOP to run the PCOP software.
```

12. Remove the diskette from the disk drive, and store the diskettes in a safe location.
13. The computer must now be re-booted in order to complete the INSTALL procedure. Press CTRL-ALT-DELETE to re-boot the computer.
14. If you are using a Workmaster industrial computer, skip to step 15. If you are using a Workmaster II industrial computer or other MS-DOS based computer, you need to use the **TERMSET** program to modify the **TERM.DAT** file for your computer. For more information, refer to chapter 2, section 4, *TERMF Installation and Configuration*, of the *Series 90 Programmable Coprocessor Module and Support Software User's Manual*, GFK-0255.
15. Then, continue with the information on the next page on connecting the PCM to the programmer.

Local Configuration File

If you frequently use more than one setup, you can save each configuration in its own file. You can name the local configuration file by specifying it when you invoke **TERMSET**, as follows:

```
TERMSET [new filename]
```

For example, to run PCOP on an IBM personal computer with an EGA display and on an IBM personal computer with a monochrome display, type **TERMSET TERM.EGA** and answer the questions about your first setup (a color monitor driven by an EGA graphics card). **TERMSET** saves this data to a file named **TERM.EGA**, instead of **TERM.DAT**. Then, create a file named **TERM.MON** to describe the monochrome monitor by typing **TERMSET TERM.MON**.

Whenever you need to change your configuration to the EGA setup, type:

```
COPY TERM.EGA TERM.DAT
PCOP
```

Or, for the monochrome monitor, type:

```
COPY TERM.MON TERM.DAT
PCOP
```

You could also specify which file to use when you invoke PCOP, as follows:

```
PCOP TERM.MON
```

Connecting the PCM to the Programmer

To connect the PCM to the programmer:

1. Connect the cable between the PCM and the IBM PC-XT, PC-AT, Workmaster II, Workmaster, or CIMSTAR I industrial computer, to the top port on the PCM and the serial port on the PC.
2. After the MS-DOS prompt is displayed on the command line, type **PCOP**.
3. Press the Restart/Reset pushbutton for more than 5 seconds to initiate a hard reset and place the PCM in program mode.
4. PCOP can detect when the PCM is connected and should set (within approximately 10 seconds) the **ONLINE** flag. This flag is displayed close to the bottom of the display screen. PCOP can also detect when the PCM is disconnected and will then display the **NO COMM** flag, after a short delay.

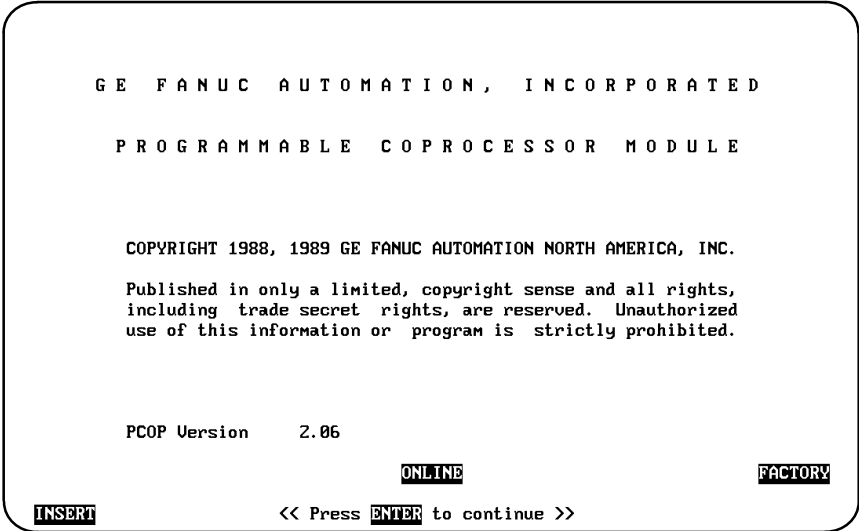

The information displayed on this screen includes a copyright statement and software version number. Please note this version number. If the software version on the PCM is not compatible with PCOP, an error message is reported and PCOP will not continue.

If you are using the special 91-key keyboard, which was designed for Logicmaster programming software packages, some of the cursor-positioning keys are not available. However, this keyboard can be put into an IBM PC-compatible mode by pressing CTRL-ALT-S. It is highly recommended that you use an IBM PC-XT keyboard so that you can use these special cursor keys.

Diagnosing Serial Communication Problems

Before proceeding, verify that the OK LED on the PCM is on. If the LED is off, refer to the *Series 90 Programmable Coprocessor Module and Support Software User's Manual*, GFK-0255.

This procedure is used to determine if there is a hardware problem with the PCM, cable, or programmer serial ports.

1. Verify that both the PCM and the programmer are using the same type of handshaking (**HARDWARE**, **SOFTWARE**, or **NONE**).
2. Verify that the cable connections are correct, and that the cable is firmly secured at both ends. (Refer to appendix A, *PCM Cabling Information*, in GFK-0255.)
3. Press the PCM Restart/Reset pushbutton for more than 5 seconds. The middle light on the PCM should blink. If it does not, remove the connector from the PCM, jumper pins 4 and 5 on the PCM with a paper clip, and press the Restart/Reset pushbutton again for more than 5 seconds. If the LED still does not blink at least once, there is a problem with the PCM. Otherwise, the cable, programmer configuration, or programmer hardware is the problem; continue with step 4.
4. Reconnect the cable to the PCM. If the programmer has more than one serial port, be sure the cable is connected to COM1. Set the programmer serial port to the PCM default settings. To do this when using a computer as the programmer, type **TERMF DEFAULT.DAT** at the MS-DOS prompt and press the Enter key.
5. Press and hold the PCM Restart/Reset pushbutton for more than 5 seconds to initialize the PCM to its factory default settings.
6. Press the programmer Enter key while watching the USER1 LED for serial port 1 or USER2 LED for serial port 2. Each time the key is pressed the LED should blink. If the PCM has been configured by Logicmaster 90 software in BASIC or BAS/CCM mode, the "Ready" prompt should also be repeated on the programmer screen; otherwise, the ">" prompt should appear. If the LED does not blink or the "Ready" or ">" prompt is not displayed, either the connection from the programmer to the PCM is bad or the programmer hardware is defective.
7. Cycle power on the programmer to make sure the serial controller is fully reset. Problems with the programmer are very rare. When they do occur, they can often be fixed with a power cycle. If your programmer is a computer, type **TERMF DEFAULT.DAT** again. If the LED still does not blink when a key is pressed, there is a problem with the cable or the programmer serial port hardware. If TERMF communicates with the PCM but PCOP does not, continue with step 8.
8. Press CTRL-BREAK or ALT-Z to exit TERMF.
9. Type **PCOP** at the MS-DOS prompt on the command line. If you again encounter communication problems between PCOP and the PCM, the problem may be with PCOP on your programmer. Try to return to MS-DOS by pressing CTRL-BREAK. If this does not work, press CTRL-ALT-DELETE to re-boot the PC. Now, start up the software again.
10. If PCOP still does not go **ONLINE** there is probably a configuration mismatch. Exit PCOP. Restart the PCM with a hard reset. Type **PCOP DEFAULT.DAT** at the prompt on the command line, and press and hold the Restart/Reset pushbutton on the PCM for more than 5 seconds.

Chapter 3

Using PCOP to Program the PCM

The PCM development software, PCOP, runs on an MS-DOS based computer and communicates with the PCM over a serial link. PCOP enables you to edit configuration, program and run MegaBasic, load and save files, and perform other status and control functions. PCOP also supports folder and file maintenance commands.

This chapter contains the following sections:

Section 1. PCOP Main Menu: describes how to invoke PCOP and the PCOP main menu.

Section 2. MegaBasic: describes how to access MegaBasic from PCOP.

Section 3. TERMF: describes how to make the PC emulate a VT100 terminal and how to transfer files to and from the PCM.

Section 4. Status Functions: describes how to display errors accumulated from the PCM and display information about currently active tasks.

Section 5. Control Functions: describes how to change the configuration mode of the PCM, start and stop user tasks, and redefine the user LEDs.

Section 6. Program Folder Functions: describes how to organize program and configuration files in a common program folder.

Section 7. Program Utility Functions: describes how to manipulate files and memory modules on the PCM.

Section 1: PCOP Main Menu

PCOP is a menu-based software package which is similar in operation to Logicmaster 90 programming software. Using PCOP, you can communicate with the PCM through the serial ports. PCOP provides functions for configuration editing, programming and running MegaBasic, loading and saving files, and other status and control functions. PCOP also supports folder and file maintenance commands.

Invoking PCOP

The PCOP software is invoked by pressing the PCM (F3) softkey from the Logicmaster 90 Programming Software main menu shown below.

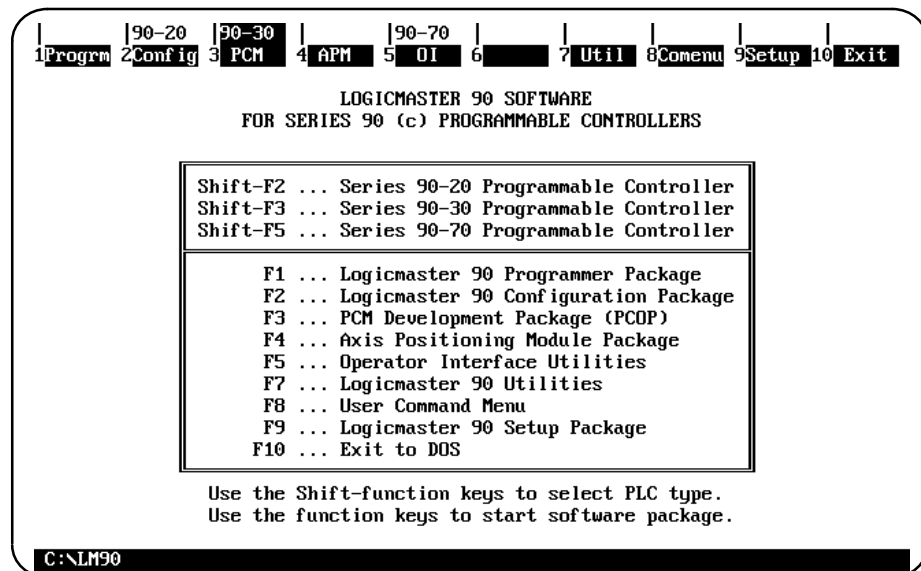

The PCOP software may also be invoked by typing `PCOP` at the MS-DOS prompt and pressing the Enter key. When PCOP is started, the title screen is displayed.

The PCM is ready to communicate with PCOP as soon as the diagnostic checks have passed and the operating system has been initialized. If there is no user configuration or soft switch data from the PLC, the factory default configuration is used to configure the serial ports and PCOP is assigned to PCM serial port 1. This is the usual programming mode.

Upon a hard reset, the PCM will come up in the same manner as if the module did not have any configuration data except the serial port settings configured using Logicmaster 90 software, but with the ability to restart with the PCM user configuration after a soft reset.

If the cable from the PCM to the computer is attached and the PCM is communicating with PCOP, the title screen indicates an **ONLINE** status.

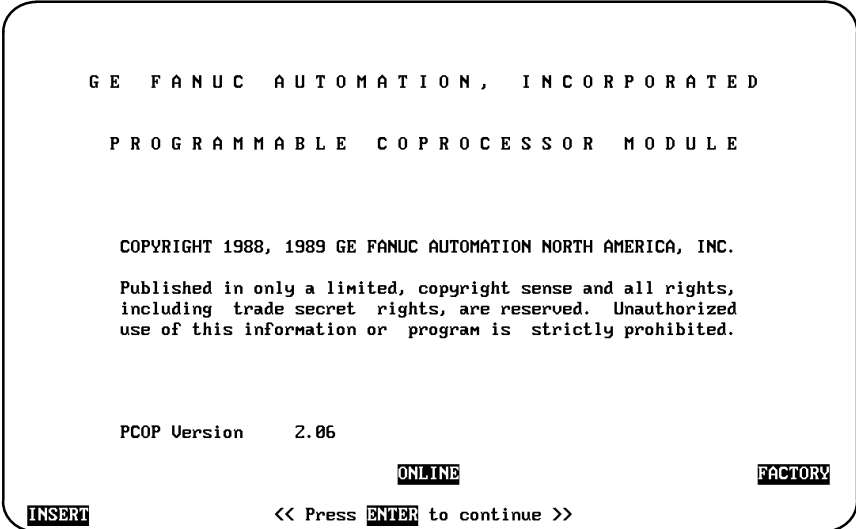

If PCOP is started after the PCM has powered up, the current screen should immediately indicate **ONLINE** status, as shown above.

If the PCM powers up while PCOP is on the title screen and the programmer is still assigned to the port, the screen will first indicate a **NO COMM** (No Communications) status and will then change to **ONLINE** status.

If the PCM is no longer communicating over the port and no output occurs on this port, PCOP will change to **NO COMM** status.

If the PCM powers up or is reset with MegaBasic or CCM attached to the port and sending data, PCOP will automatically go into terminal emulation mode.

Press the Enter key to leave the banner/copyright screen.

Accessing the PCOP Main Menu

After selecting the current folder, the PCOP main menu is displayed.

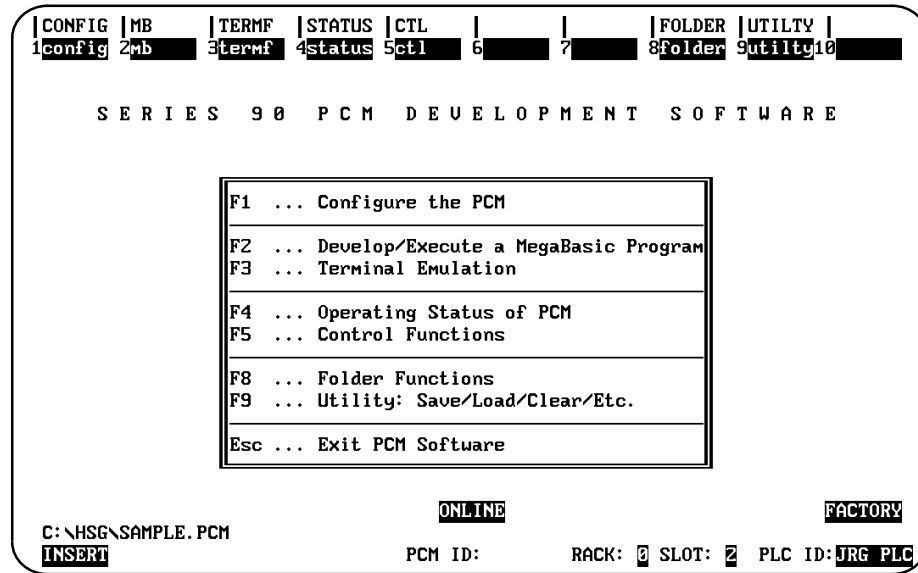

The F1 through F10 function softkeys, displayed at the top of each screen, are used to select the desired function. Each of these selections will access another screen. The function of each shifted function key is displayed on the top line in all capital letters. These are generally the function keys available on the previous menu.

The Escape key can be used at any time to abort the current menu and return to the previous display screen, unless there is an active command for the PCM in progress. CTRL-BREAK can be pressed at any time to abort the current menu and return to either MS-DOS or the Logimaster 90 Programming Software main menu.

The **PCMRUNTIMEERRORS** indication is displayed on the PCOP menu screens if errors have been reported by the PCM. Press Status (F4) from the PCOP main menu and then press F1 from the Status Functions menu to display the errors.

The **ONLINE** indication is displayed as long as the PCM is communicating with PCOP. If the PCM becomes disabled or PCOP communication is assigned to another device, the **ONLINE** indication changes to **NO COMM**. In order to configure or program the PCM, PCOP must be on-line. If this is not the case, refer to the troubleshooting information, "Diagnosing Serial Communication Problems," in chapter 2, *Installing the PCM Software*.

If the PCM powers up or is reset with MegaBasic or CCM attached to the port and sending data, the screen is cleared and then displays the TERMF banner. PCOP communication has been detached. If necessary, PCOP to PCM communication can be re-established by pressing the Restart/Reset pushbutton continuously for more than 5 seconds to initiate a hard reset.

The **Current Configuration** field in the lower right corner of the screen indicates whether there is no Logicmaster 90 or PCOP user configuration (FACTORY), there is a Logicmaster 90 configuration for the PCM programmer port and a hard reset has occurred (FAC MOD), a Logicmaster 90 configuration is active after a soft reset occurred (LM CFG), or a PCOP user configuration is active after a soft reset (USER).

The **PCM ID** is the name of the PCM board supplied by the user configuration data, if any. Rack, slot, and CPU ID data are supplied from the backplane and from the power-up information supplied by the PLC CPU. The **ONLINE/NOCOMM** indication, current configuration, and PCM ID, rack, slot, CPU ID entries are displayed in reverse video at the bottom of each display screen.

Message Line

Errors in command syntax, or those discovered while executing commands or selections, are displayed on the message line. The message line is located directly below the softkey labels on the display screen.

Prompts for additional information required from the user and general help information are also displayed on the message line.

Expert Mode

Expert mode in PCOP provides shortcuts and reduces the keystrokes required when using the menu softkeys. Once you are familiar with PCOP, you may select expert mode at any time by pressing ALT-J. (PCOP always starts up in non-expert mode.) Pressing ALT-J a second time will toggle expert mode off again.

Commands may be entered on the command line at the ">" prompt in expert mode, instead of, or in addition to, using the function softkeys. Commands are not limited to those selections shown on a particular screen, as they are when using the function softkeys.

The commands for expert mode are the same as the labels displayed on the function softkeys. Only the first three characters are significant. Although additional characters may be entered, they are ignored.

Parameters are prompted for on the message line. Read the prompt carefully and respond to each question. Chapter 5, *Using PCOP in Expert Mode*, describes the command format for each command.

Special Key Commands

The five special key commands are listed in the following table.

Key	Description
CTRL-BREAK	Exit PCOP and return to MS-DOS or the Logicmaster 90 Programming Software main menu.
Escape	Display the previous screen. Incomplete commands are aborted.
ALT-A	Abort the current command.
ALT-H	Display Help text in the configuration editor.
ALT-J	Toggle between expert and non-expert mode.

Key Summary

The PCOP main menu displays the following function softkeys, summarized below. These function keys are described in more detail in subsequent sections of this chapter.

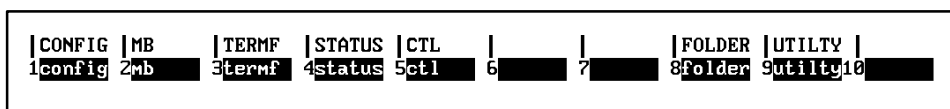

Function Key	Function	Description
F1	ConfigurationEditor	Enter the PCOP configuration editor. For more information on the configuration editor, refer to chapter 3, <i>Using PCOP to Configure the PCM</i> .
F2	MegaBasic Interpreter	Start the MegaBasic interpreter. After entering MegaBasic, you may develop, run, alter, and debug an application program.
F3	TERMF	Enter the terminal emulation software part of PCOP. This screen can be used for program output while debugging programs, or for any other terminal type activity.
F4	Status Functions	Display the Status Functions menu. These commands are used to access information about the operating status of the PCM.
F5	Control Functions	Display the Control Functions menu. These commands are used to change the PCM active configuration, temporary assignment of the user LEDs, and to run or stop user tasks. Control functions are only available in On-Line mode.
F8	Program Folder Functions	Display the Program Folder Functions menu. These commands are used to organize program and configuration files in a common program folder.
F9	Program Utility Functions	Access the Program Utility Functions menu. These commands are used to load and save programs, configuration files, and directories, to delete files, and to clear files located on the PCM.

Section 2: MegaBasic

MegaBasic is a powerful implementation of the BASIC programming language. To learn about the features of MegaBasic, refer to the *MegaBasic Programming Language Reference Manual*, GFK-0256.

MegaBasic is built into the PCM and has been provided with extensions which provide access to the PCM and the PLC in which it is installed. For information about special features of MegaBasic in the PCM, refer to the *Series 90 Programmable Coprocessor Module and Support Software User's Manual*, GFK-0255.

Accessing MegaBasic from PCOP

When PCOP is on-line with the PCM, you can access MegaBasic in the PCM by pressing the F2 function key at the PCOP main menu. The MegaBasic start-up banner should appear.

```
MegaBasic (tm) Version 5.70, for PCM VTOS v3.02
IEEE/Software floating point on an 80186/88 CPU

(C) Copyright 1981-1993 by Christopher Cochran
Programmable Coprocessor Module Version

Ready
```

Returning to PCOP

From the MegaBasic "Ready" prompt, you can return to PCOP by typing the **BYE** command and pressing the Enter key. When a MegaBasic program is running, you can usually halt it by pressing CTRL-C. (Press and hold the CTRL key down while pressing the C key.) MegaBasic should display a CTRL-C stop message, followed by the Ready prompt. However, some MegaBasic programs disable CTRL-C. If CTRL-C does not stop the program, hold the PCM Restart/Reset pushbutton for more than 5 seconds to initiate a hard reset. When you see a "-->" prompt, press ALT-Z to return to PCOP.

Section 3: TERMF

TERMF is a terminal emulation software package, invoked from PCOP or MS-DOS. It is used to make the PC emulate a VT100 terminal and to transfer files. Not all VT100 escape sequences are supported; those which are not supported are either displayed on the screen or ignored.

Features of the TERMF terminal emulation software package include:

- The small size of TERMF, as compared with other terminal emulation packages.
- PC-to-PCM file transfer protocol.
- The ability to redefine keys.

TERMF is also available separately as catalog number IC641SWP063. For additional information on using TERMF, see the *Series 90 Programmable Coprocessor Module and Support Software User's Manual*, GFK-0255.

Invoking TERMF

The TERMF terminal emulation software is invoked directly from the PCOP main menu by selecting TERMF (F3). This allows monitoring of a MegaBasic program that is currently executing. TERMF may also be invoked directly from MS-DOS instead of PCOP.

TERMF is also invoked automatically when the PCM sends output on the serial port attached to PCOP. This happens, for example, when a soft reset starts MegaBasic.

Along with TERMF software, which is integrated very closely with PCOP, an additional terminal emulation program is supplied. This program is called **TERM.EXE** and is generally the same as TERMF, except that it does not include the PC-to-PCM file transfer protocol.

The setup of configuration data for the programmer is done through a companion program called **TERMSET.EXE**, which sets up the data file **TERM.DAT** that TERMF reads and uses for configuration data. The TERMF configuration data in **TERM.DAT** includes serial port setup for the PC, monitor selection, and an off-line default for PCOP configuration (30 vs 70).

Returning to PCOP

To return to PCOP from TERMF, press ALT-Z. Press CTRL-BREAK to exit to MS-DOS.

When the ">" symbol is displayed on the TERMF screen, a PCM reset has occurred. You may need to return to PCOP. If you were in PCOP, press ALT-Z to return to PCOP. Or, press CTRL-BREAK to exit to MS-DOS and re-enter PCOP.

Section 4: Status Functions

The Status Functions menu provides access to status information about the PCM. Status information includes errors accumulated from the PCM while the PCOP package is attached and also information about the currently active tasks and configuration. To display this screen, press the STATUS (F4) softkey from the PCOP main menu.

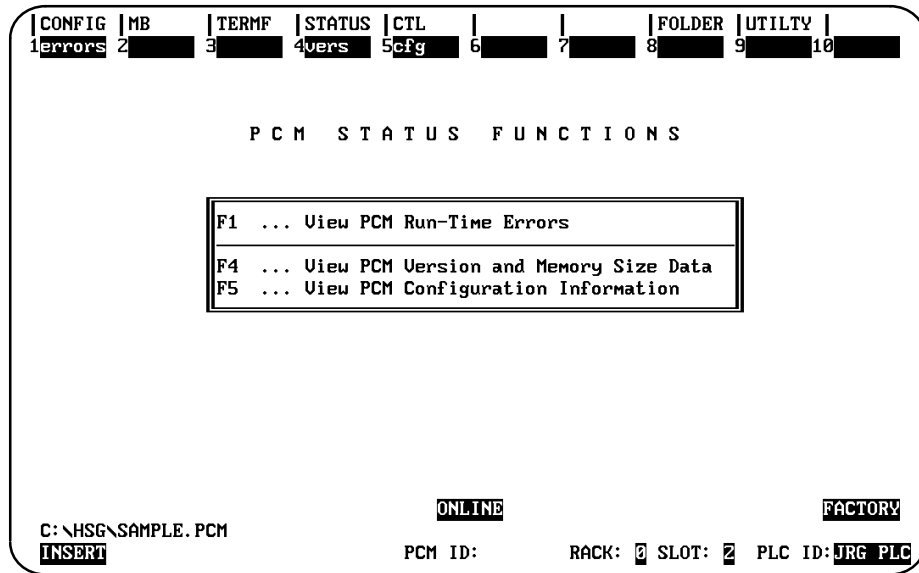

Error Display Screen

Errors accumulated from the PCM while the PCOP package is attached are displayed on the Error Display screen. To display this screen, press the ERRORS (F1) softkey from the Status Display menu.

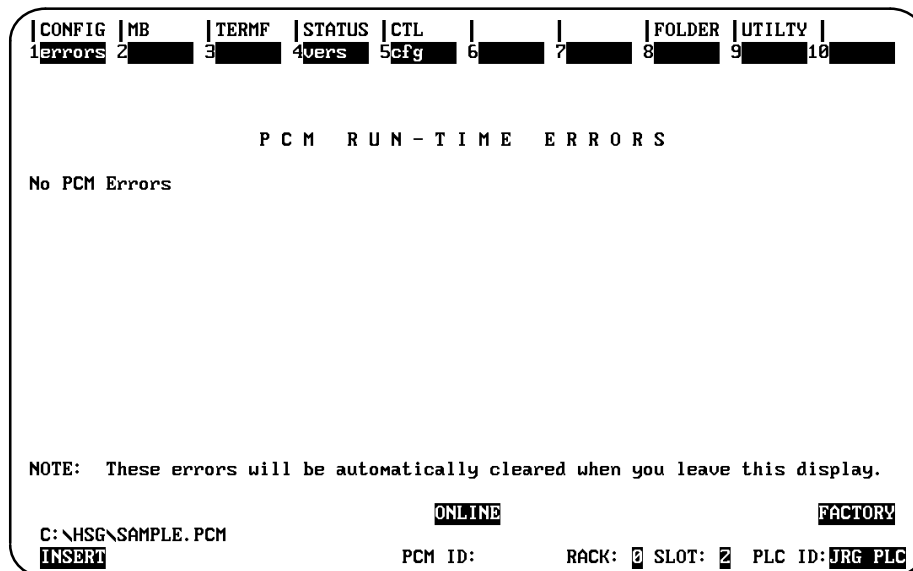

If there are more than eight errors, only the most recent eight are displayed. These errors are cleared from the screen after exiting this screen. The "PCM Runtime Errors" message is also cleared after exiting this screen.

Two types of errors are processed by PCOP:

Type of Error	Description
User Command Syntax Errors	All syntax errors are found and reported locally on the message line within the PCOP routine. These errors are not accumulated for display on the PCM Runtime Errors screen. For example, errors in file names that can be detected by PCOP will report an error message above the command line.
Execution Errors	Execution errors are detected by the PCM and passed to PCOP for display. These errors are listed on the PCM Runtime Errors screen.

PCOP will determine the error type and associated message, and store execution errors for display on the Error Display screen. A maximum of eight execution errors can be stored by PCOP; these are the last eight errors stored from the PCM. They are stored until they are displayed on the Error Display screen, at which time they are cleared, or until PCOP is disconnected or exited. The runtime error line on the display screen will indicate whether any new error messages have been received from the PCM.

Possible error messages reported on the PCM Runtime Errors screen include "Insufficient Memory," "File not Found," and "Module not Found." These errors are usually displayed when something is missing from a configuration or program file. Reload the PCM software and try again.

Section 5: Control Functions

Control functions are used to change the configuration mode of the PCM, start and stop user tasks, and redefine the user LEDs. The Control Functions menu is only available in On-Line mode. To display this screen, press the CTL (F5) softkey from the PCOP main menu.

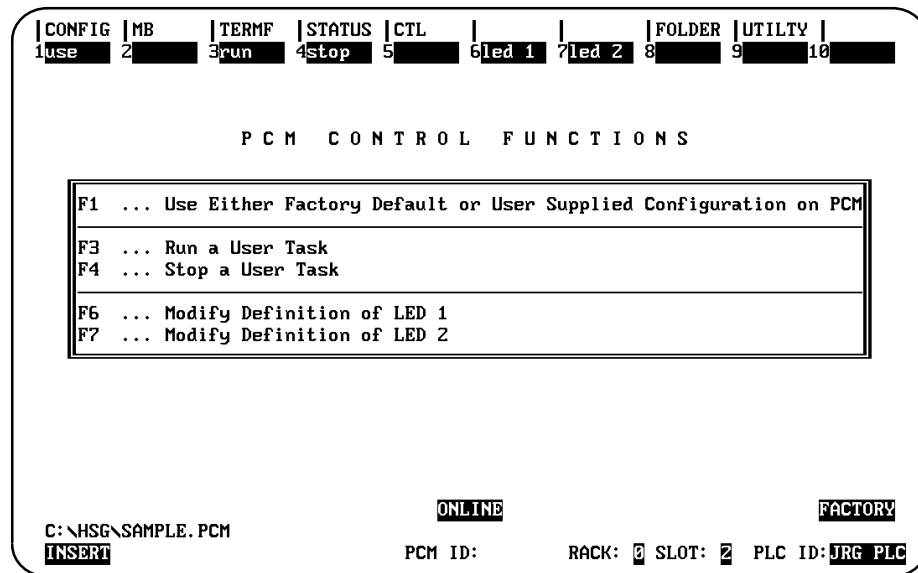

Function Key	Function	Description
F1	Use	Display the Use Configuration menu screen.
F3	Run	Display the Run User Task screen. A task, or group of tasks, specified by a module name begin executing.
F4	Stop	Display the Stop User Task screen.
F6	LED 1	Redefine the assignments for User LED 1.
F7	LED 2	Redefine the assignments for User LED 2.

Changing PCM Configuration Mode

The **USE** command establishes the chosen data as the current active configuration. Selecting **factory** on the USE Configuration Data screen is the same as initiating a hard reset, while selecting **user** initiates a soft reset. This provides a remote reset function, as long as PCOP remains connected and on-line with the PCM.

The USE Configuration Data screen is only available in On-Line mode. To display this screen, press the USE (F1) softkey from the Control Functions menu.

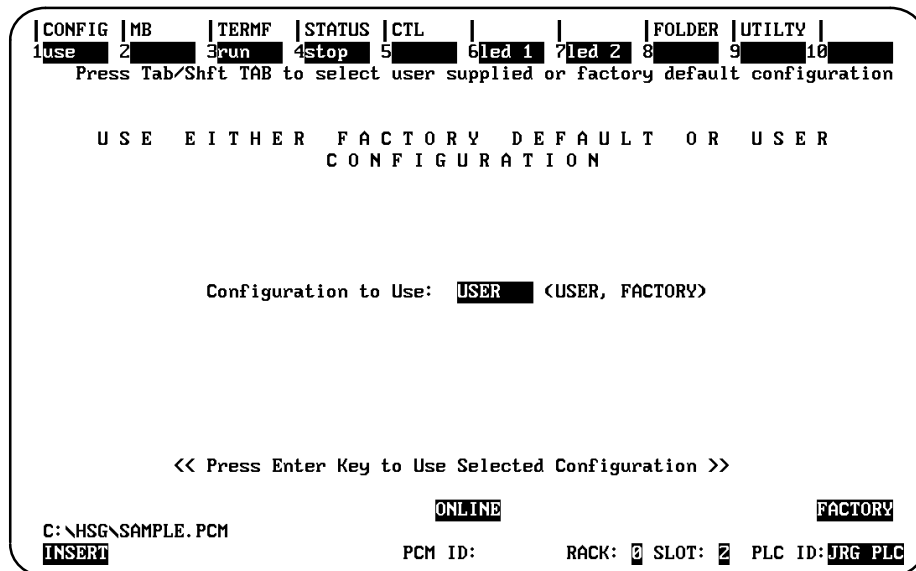

Executing a Task

The **RUN** command causes a task, or group of tasks, specified by a module name to begin executing. In foreground mode, the PCM cannot be used for anything else while the task is executing. In background mode, the PCM can be used for other activities while the task is executing.

The RUN User Task screen is only available in On-Line mode. To display this screen, press the RUN (F3) softkey from the Control Functions menu.

CONFIG	MB	TERMF	STATUS	CTL		FOLDER	UTILTY
1use	2	3run	4stop	5	6led 1	7led 2	8
9	10	Enter Task Name to Run					
R U N A U S E R T A S K							
Name of Task to Run: <input type="text"/>				Use Stack Size of <input type="text"/> Bytes			
Input: COM1:				Use Data Size of <input type="text"/> K Bytes			
Output: COM1:							
Error: COM1:							
Execution Mode: FOREGROUND				Task Priority: <input type="text"/>			
Link to Memory Modules:							
RAM:	<input type="text"/>	RAM:	<input type="text"/>	RAM:	<input type="text"/>	RAM:	<input type="text"/>
RAM:	<input type="text"/>	RAM:	<input type="text"/>	RAM:	<input type="text"/>	RAM:	<input type="text"/>
<< Press Enter Key to Run Indicated Task >>							
NOTE: This function is not intended for use with either MegaBasic or CCM.							
				ONLINE		FACTORY	
C:\HSG\SAMPLE.PCM							
INSERT				PCM ID:		RACK: <input type="text"/> SLOT: <input type="text"/> PLC ID: JRG PLC	

This screen provides selections for the name of the task to run, the input/output/error devices, the stack and data size for the user task, background or foreground mode, task priority, and link modules.

Caution

This function is not intended for normal use of PCOP and the PCM in this release.

Stopping a Task

The **STOP** command stops a task from executing.

The STOP User Task screen is only available in On-Line mode. To display this screen, press the STOP (F4) softkey from the Control Functions menu.

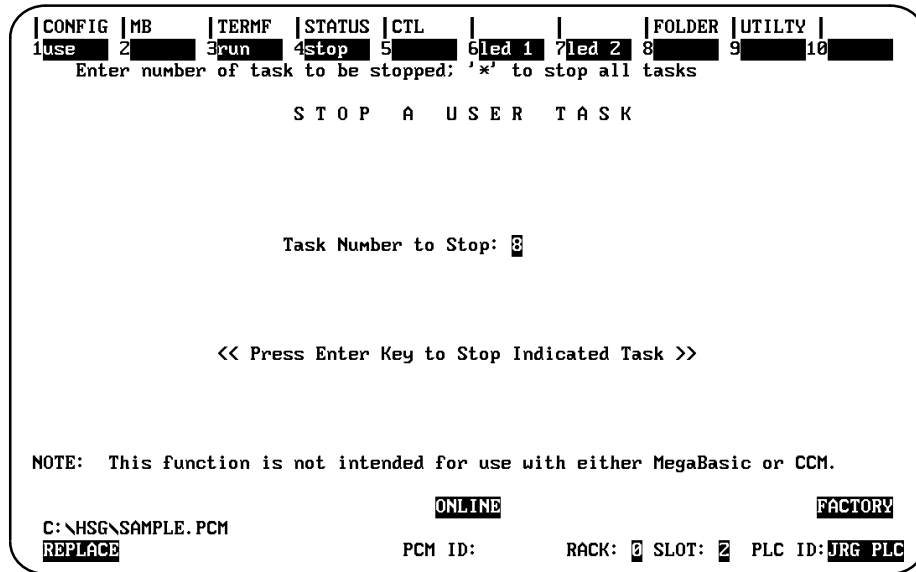

After the command is executed, the "Command Complete" message is displayed on the message line.

This function is not intended for normal use of PCOP and the PCM in this release.

Caution

The STOP command is not fully supported for this release. It is recommended that you perform a reset instead of using the STOP command.

Redefining the User LEDs

The **LED USE** command allows you to interactively and temporarily redefine the assignments for the user LEDs.

The User LED Definition Attributes screen is only available in On-Line mode. To display this screen, press the LED 1 (F6) softkey for LED 1.

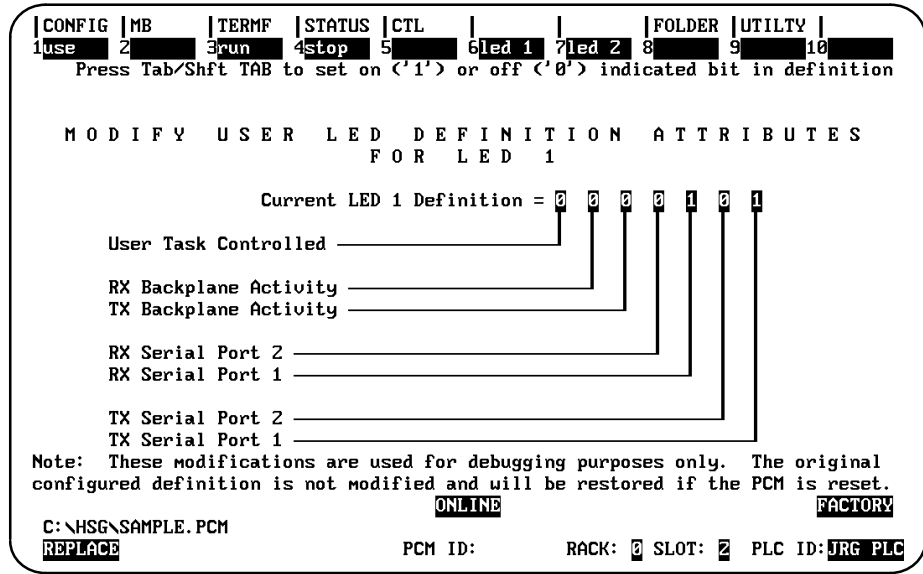

Press the LED 2 (F7) softkey to display the User LED Definition Attributes screen for LED 2.

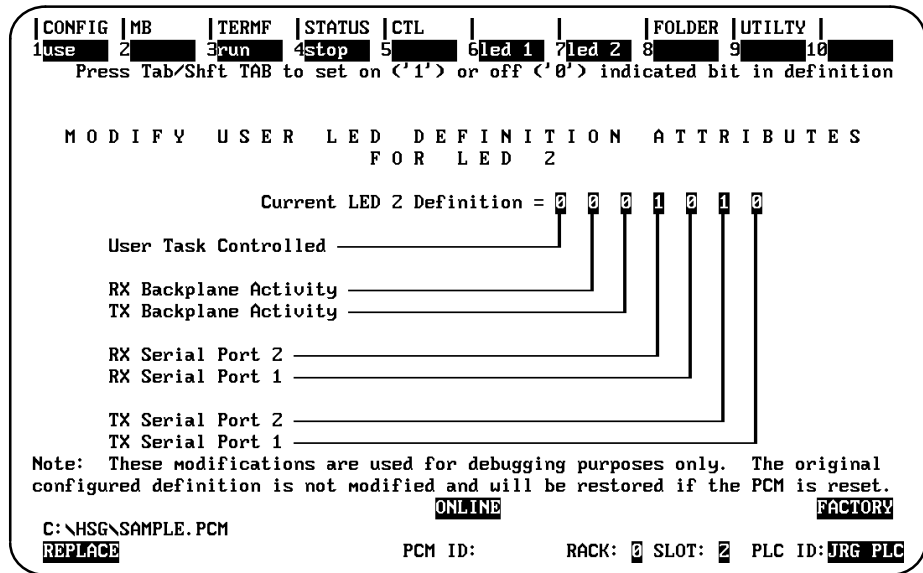

The current definition of the LED is displayed on the screens shown above. To select or deselect an attribute, position the cursor on the desired attribute and press the Tab key to toggle the bit. A 1 means the attribute is enabled; 0 means it is disabled. Multiple attributes may be selected.

When the user task is chosen, the task number that will control the LED must be entered at the prompt. The task number is the same as the task priority.

Section 6: Program Folder Functions

Program folder functions are used to organize program and configuration files in a common PCM program folder. A program folder is actually a subdirectory of files. PCM folders are similar to Logicmaster 90 folders, except that PCM folder names have the extension `.PCM`. To display this screen, press the FOLDER (F8) softkey from the PCOP main menu.

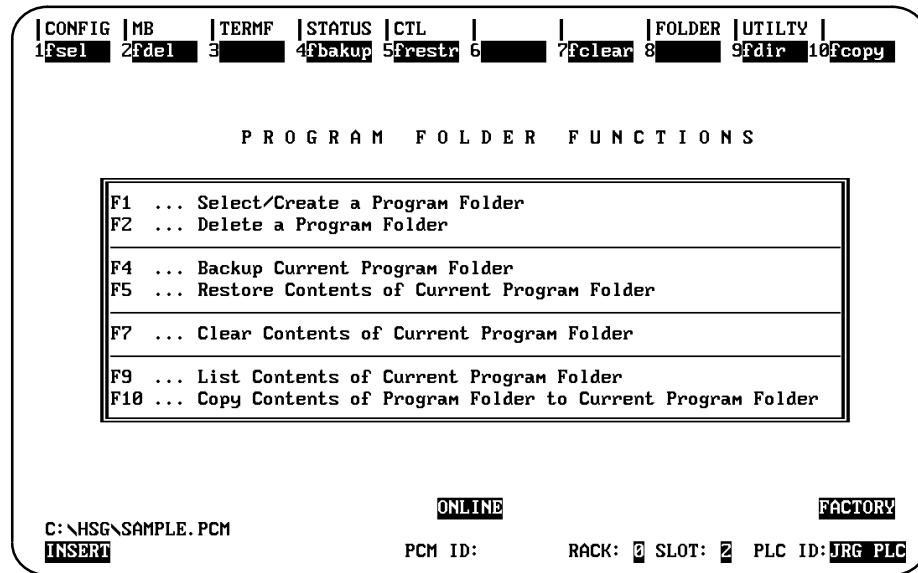

Function Key	Function	Description
F1	Select Folder	Create or select a program folder.
F2	Delete Folder	Delete a program folder.
F4	Backup Folder	Create a backup copy of the current program folder.
F5	Restore Folder	Restore a program folder from its backup copy.
F7	Clear Folder	Clear the contents of the current program folder.
F9	FolderDirectory	List the contents of the current program folder.
F10	Copy Folder	Copy the contents of a specified program folder to the current program folder.

Backing up the Current Program Folder

To create a backup copy of the currently selected program folder, press the FBAKUP (F4) softkey from the Program Folder Functions menu.

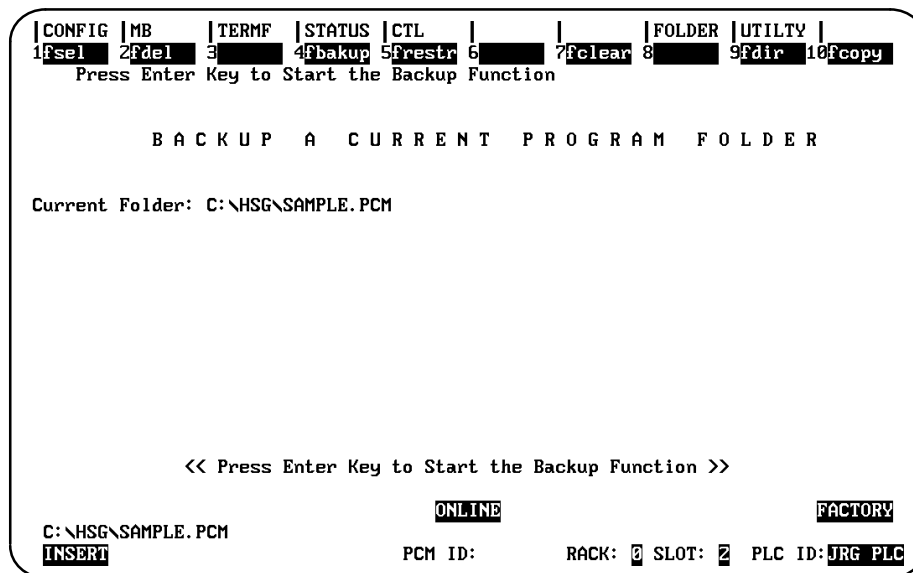

The backup folder is located in a subdirectory under the program folder. If no backup folder exists for the current program folder, one is automatically created. If the program folder has been backed up previously, the backup function will write over the previous backup copy.

Note

Multiple backups of the same program folder are not maintained.

To back up the current program folder, press the Enter key. Press the Escape key to return to the Program Folder Functions menu.

Restoring the Current Program Folder

To replace the contents of the current program folder by its backup copy, press the FRESTR (F5) softkey from the Program Folder Functions menu. In order to restore a program folder, a backup copy must already exist.

If the program folder is locked (locked status is shown in the lower right corner of the screen), you must change the status to unlocked before restoring the program folder. Refer to the information on locking and unlocking a program folder, provided later in this section.

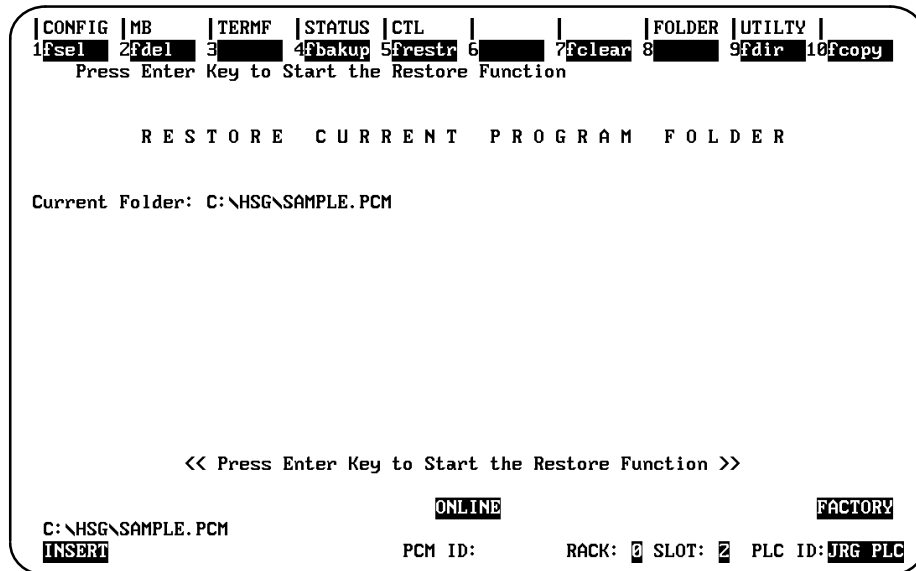

To begin the restore operation, press the Enter key. If any information exists in the current program folder that would be written over by the backup information, you must confirm the request in order to proceed. **Once started, the restore operation cannot be stopped**

To return to the Program Folder Functions menu, press the Escape key.

Clearing the Current Program Folder

To delete the contents of the current program folder while keeping the folder for future use, press the FCLEAR (F7) softkey from the Program Folder Functions menu.

If a program folder is locked (look at the lower right corner of the screen), it cannot be cleared. Refer to the information on locking and unlocking a program folder, provided later in this section.

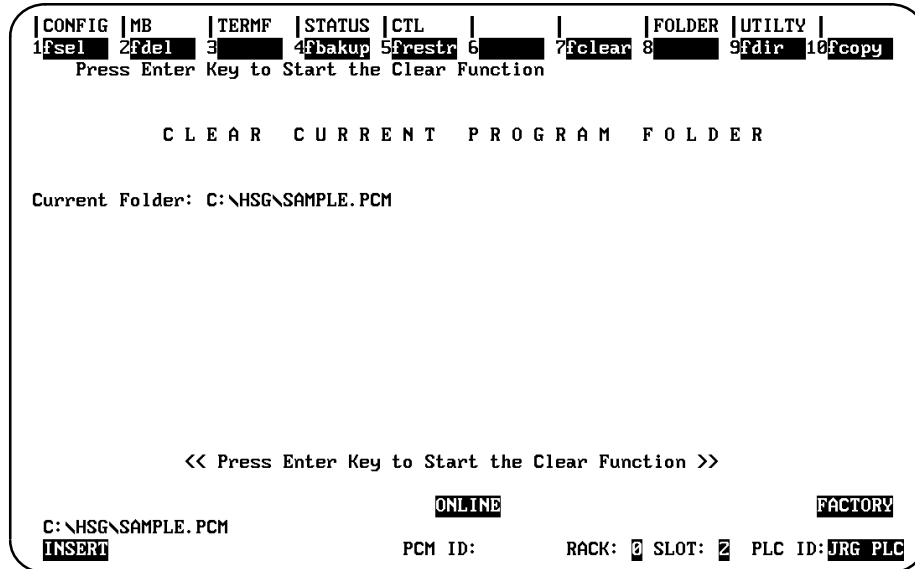

To clear the current program folder, press the Enter key. If there is any information in the program folder, you must confirm the request in order to continue the clear operation.

If you press **Y** to the continuation prompt, you will have a chance to back up the current program folder. To create a backup version of the information, press **Y** again. Press **N** if you do not want to back up the information first.

To return to the Program Folder Functions menu, press the Escape key.

Listing the Contents of the Current Program Folder

Use the Folder Directory function to obtain a list of the files that are in the current program folder. To obtain the list, press the FDIR (F9) softkey from the Program Folder Functions menu.

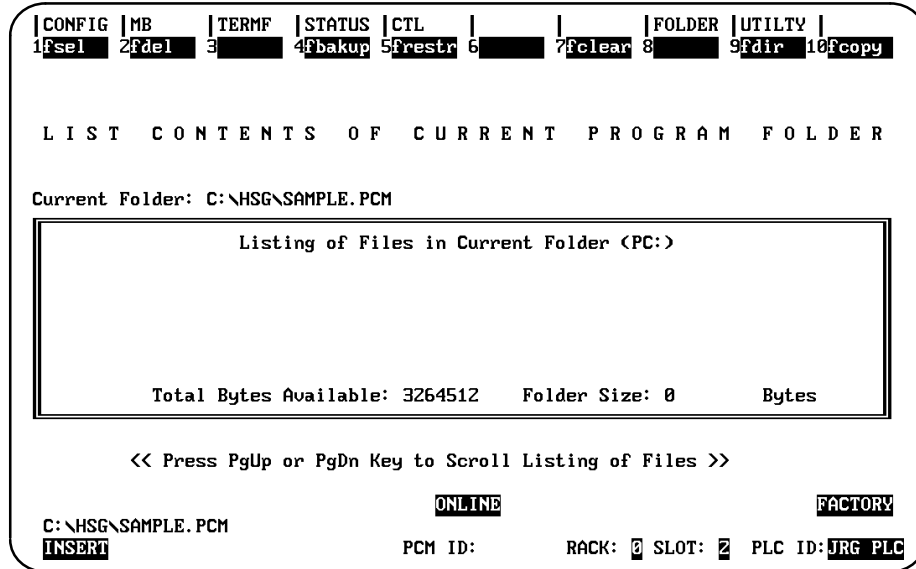

In addition to a list of the files in the current folder, the number of bytes available on the disk and the number of bytes that are being used by the current folder are also displayed on this screen.

If more file names are in the current folder than can be displayed on the screen at one time, use the Page Up/Down cursor keys to page through the file names.

To return to the Program Folder Functions menu, press the Escape key.

Section 7: Program Utility Functions

Program utility functions are used to manipulate files and memory modules on the PCM. The Program Utilities menu is only available in On-Line mode. To display this screen, press the UTILTY (F9) softkey from the PCOP main menu.

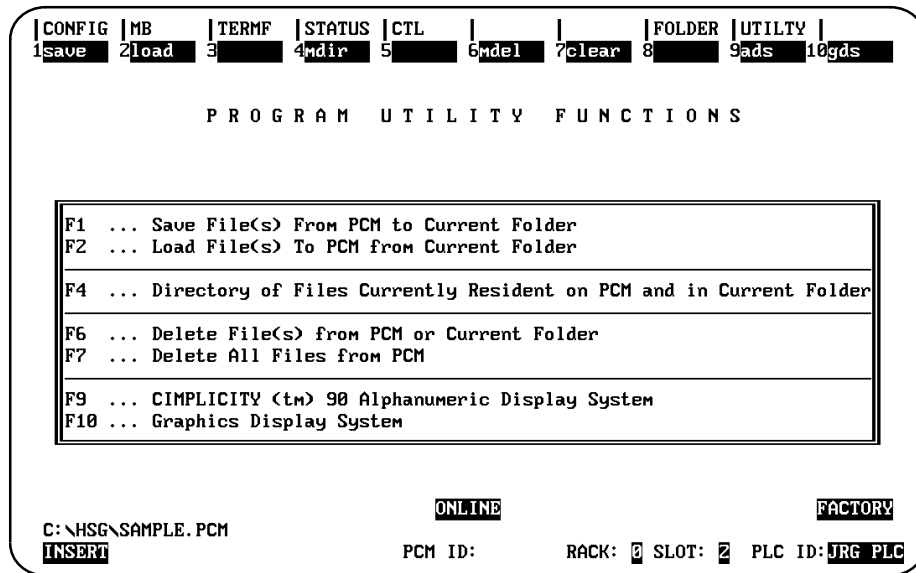

Function Key	Function	Description
F1	Save File	Copy user programs, data, and configuration files from the PCM RAM Disk into a PC folder. For versions prior to 2.04 of the PCM development software, data files and memory modules can be saved, but executable files (those with the extension .EXE) cannot be saved. MegaBasic has a similar SAVE command for saving MegaBasic source programs to any valid device.
F2	Load File	Load programs, user files, and configuration files from the PC to the PCM RAM Disk. MegaBasic programs must be loaded into the MegaBasic workspace by MegaBasic, but the files may be loaded to the RAM Disk for fast access and onboard storage by using the PCOP Load File utility.
F4	File Directory	Display a listing of the files and modules that have been loaded to the PCM and the amount of remaining memory available. Additional entries may be displayed on the screen by pressing the Page Up or Page Down key.
F6	Delete File	Delete a single file on the PCM.
F7	Clear	Remove any files currently located in PCM user memory, programs, data files, and configuration files. The purpose of the command is to return the memory to its as-shipped state, with no user memory files or other data in user memory.
F9	ADS	Initially install the CIMPLICITY 90-ADS software or change the executable environment of the CIMPLICITY 90-ADS software. This command automatically performs a soft reset and establishes the PC: drive as the current folder directory. CIMPLICITY90-ADS software is purchased separately from PCOP. It requires an Alphanumeric Display Coprocessor Module in order to use the software.
F10	GDS	Initially install the Graphics Display System (GDS) software. This command automatically performs a soft reset and establishes the PC: drive as the current folder directory. The GDS software is purchased separately from PCOP.

Press the Escape key at any time to abort the current menu and return to the previous display screen, unless there is an active command for the PCM in progress.

Saving a File from the PCM

The **SAVE** command is used to copy user programs, data, and configuration files from PCM RAM:Disk memory into a file. It is similar to the load function in the Logicmaster 90 utilities. For versions prior to 2.04 of the PCM development software, executable files (those with the extension .EXE) cannot be saved. MegaBasic has a similar **SAVE** command for saving MegaBasic programs from its memory.

The Save File(s) screen is only available in On-Line mode. To display this screen, press the SAVE (F1) softkey from the Program Utilities menu.

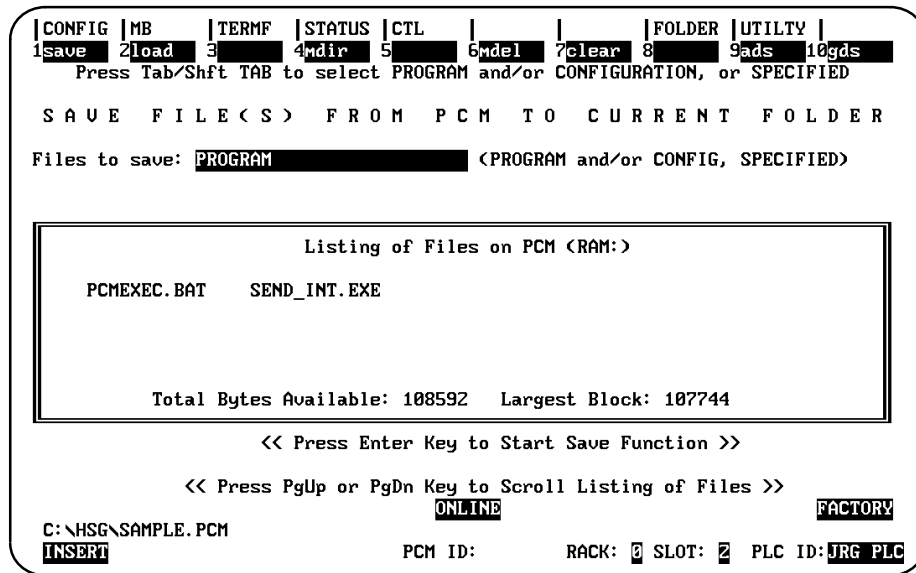

Select the type of file(s) to be saved at the **Filestosave** field. Use the Tab key to scroll through the choices listed in the following table. When the correct selection is displayed, press the Enter key.

Selection	Description
Program *	Save all user files, except the user configuration, from the PCM to the current folder.
Config	Save user configuration data to the current folder.
Program and Config	Save all user files on the PCM to the current folder on the PC.
Specified	Save a named file from the PCM to the PC. SPECIFIED can be used to save a single user program or data file, or any other file on the PCM to the PC. The name of the file to be saved must be entered on the screen.

* Default selection.

If the specified file cannot be located, the command is aborted and a "File not Found" error is displayed.

Loading a File to the PCM

The **LOAD** command is used to load user programs, data files, and configuration data from the PC into the PCM RAM Disk. It is similar to the store function in the Logicmaster 90 utilities. MegaBasic programs must be loaded into the MegaBasic workspace by MegaBasic. The files may be loaded to the RAM Disk for fast access and onboard storage by using the PCOP **LOAD** command.

The Load File(s) screen is only available in On-Line mode. To display this screen, press the **LOAD (F2)** softkey from the Program Utilities menu.

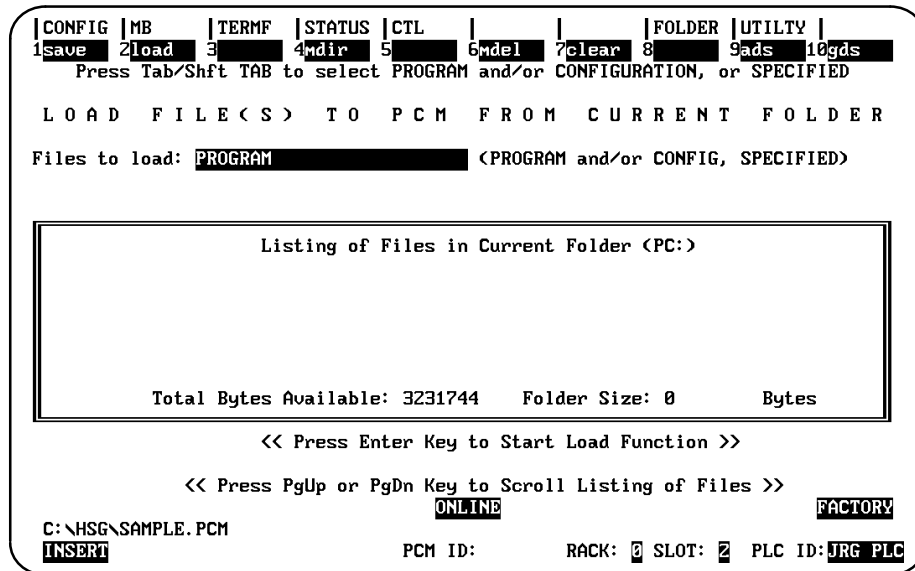

Select the type of file(s) to be loaded at the **Files to load** selection. Use the Tab key to scroll through the choices listed in the following table. When the correct selection is displayed, press the Enter key.

Selection	Description
Program *	Load all user files, except the user configuration, in the current folder.
Config	Load user configuration data located in the current folder.
Program and Config	Load all user files in the current folder to the PCM.
Specified	Load a named file to the PCM. SPECIFIED can be used to load a single user program or data file, or any other file to the PC. The name of the file to be loaded must be entered on the screen.

* Default selection.

If the specified file cannot be located, the command is aborted and a "File not Found" error is displayed.

Directory of Files

The **MDIR** command is used to list the user programs, data files, and configuration data located on the PCM RAM Disk or in the current folder.

The Directory of Files screen is only available in On-line mode. To display this screen, press the MDIR (F4) softkey from the Program Utilities menu.

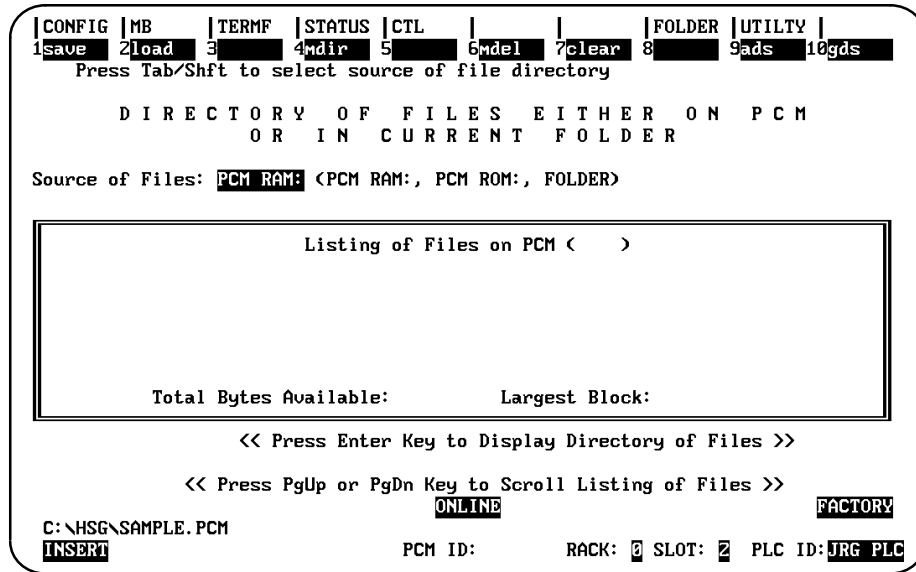

Select the list of files at the **Source of files** selection. Use the Tab key to scroll through the choices for the directory listing, as shown in the following table. When the correct selection is displayed, press the Enter key.

Selection	Description
PCM RAM: *	List all user files on the PCM RAM: Disk.
PCM ROM:	Not available for this release.
FOLDER	List all files located in the current folder.

* Default selection.

Deleting a File

The **MDEL** command is used to delete user programs, data files, and configuration data from the PCM RAM Disk or in the current folder.

The Delete File(s) screen is only available in On-Line mode. To display this screen, press the MDEL (F6) softkey from the Program Utilities menu.

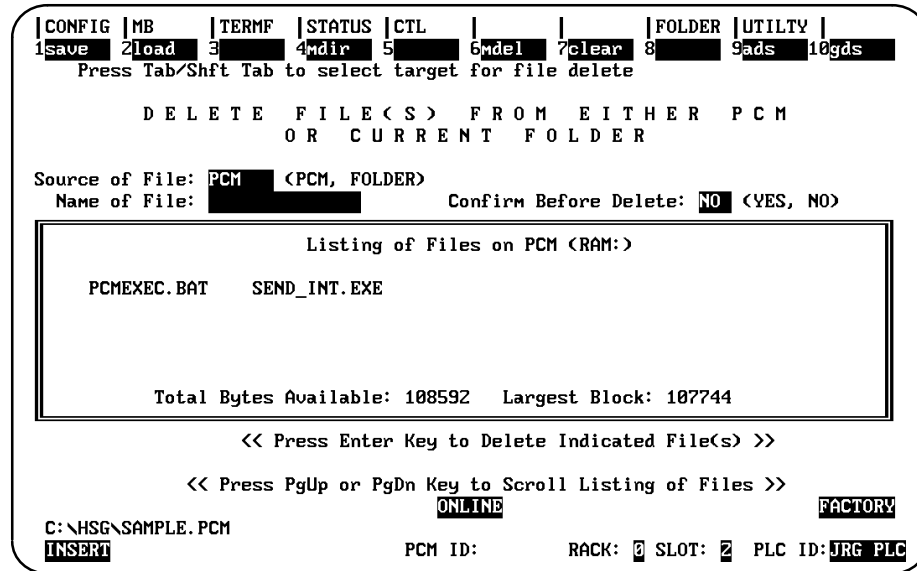

Select the location of the file to be deleted at the **Source of File** selection. Use the Tab key to scroll through the choices, as listed in the following table. When the correct selection is displayed, press the Enter key.

Selection	Description
PCM *	Select the PCM RAM Disk as the location of the file to be deleted.
Folder	Indicates that the file is located in the current folder.

* Default selection.

After selecting the source of the file to be deleted, a directory of the destination location is displayed in the window on the screen. Enter the name of the file to be deleted at **Name of File**.

Confirm Before Delete is an optional entry for initiating a confirmation prompt before any file is deleted. To use the confirmation prompt, toggle this entry to **YES** before pressing the Enter key. Otherwise, toggle the value to **NO**. Once the confirmation prompt has been changed in a particular session of PCOP, the default will retain this new value until it is changed again.

If the specified file cannot be located, the command is aborted and a "File not Found" error is displayed.

Deleting all Files on the PCM

The **CLEAR** command is used to delete all files located on the PCM RAM Disk.

The Clear PCM screen is only available in On-Line mode. To display this screen, press the CLEAR (F7) softkey from the Program Utilities menu.

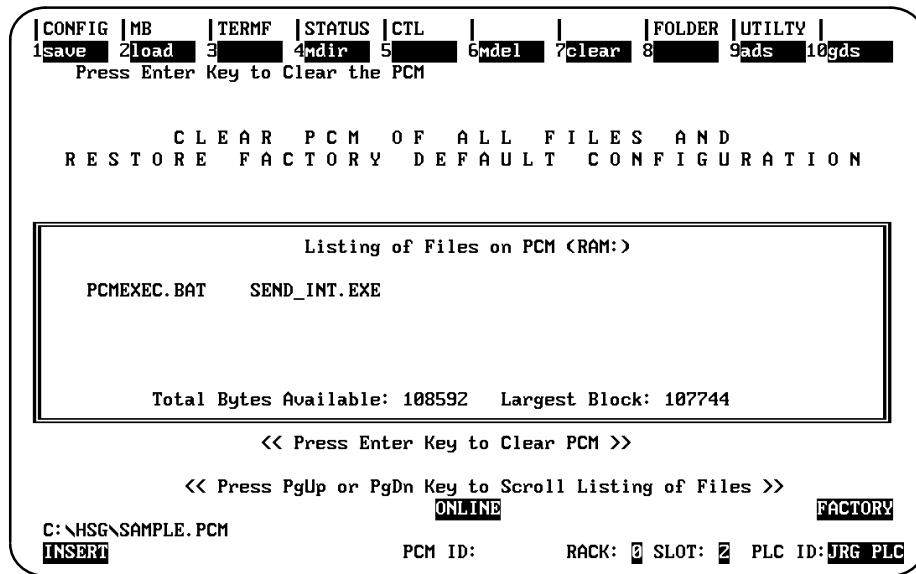

A listing of the files located on the PCM is displayed in the window. Press the Enter key to complete this command.

Using ADS Software

The **ADS** command is used to initially install the CIMPPLICITY 90-ADS software or to change the executable environment of the CIMPPLICITY 90-ADS software. This command automatically performs a soft reset and establishes the PC: drive as the current folder directory.

The ADS software screen is only available in On-Line mode. You must purchase the ADS software before this function can be used. To display this screen, press the ADS (F9) softkey from the Program Utilities menu.

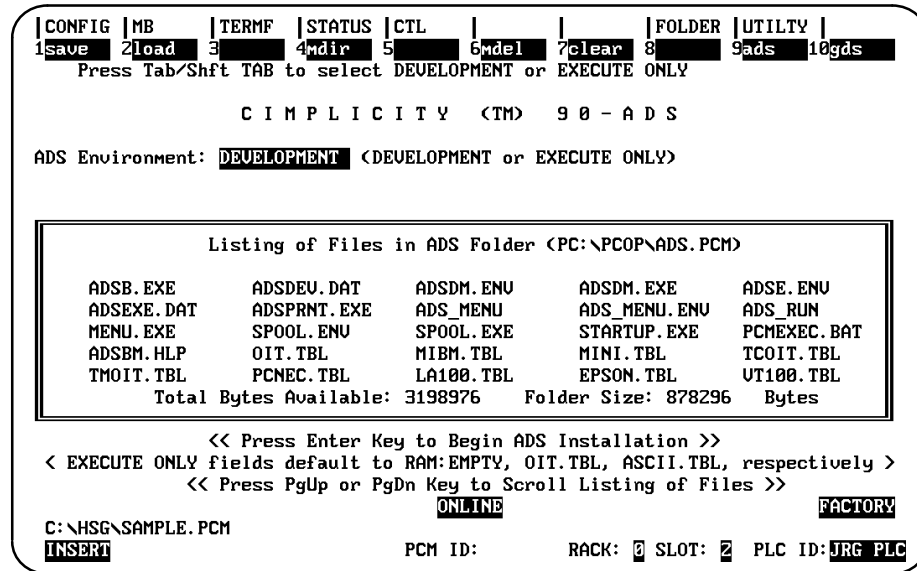

Select the ADS environment by using the Tab key to toggle between the selections (DEVELOPMENT or EXECUTE ONLY). When the correct selection is displayed, press the Enter key.

When EXECUTE ONLY is selected, the following fields are displayed:

Field	Description
SystemName	System ID. (Default = RAM:EMPTY)
Terminal Table	Terminal type. (Default = OIT.TBL)
Printer Table	The type of printer you are using. (Default = ASCII.TBL)

If these fields are left blank, PCOP uses the default values.

Note

CIMPPLICITY 90-ADS software is purchased separately from PCOP. It requires an Alphanumeric Display Coprocessor Module in order to use the software. For more information on the CIMPPLICITY 90-ADS system, refer to the *CIMPPLICITY 90-ADS User's Manual*, GFK-0499.

Using the GDS Software

The **GDS** command is used to initially install the CIMPLICITY-70 Graphics Display System (GDS) software. This command automatically performs a soft reset and establishes the PC: drive as the current folder directory.

The GDS screen is only available in On-Line mode.

To display this screen, press the GDS (F10) softkey from the Program Utilities menu.

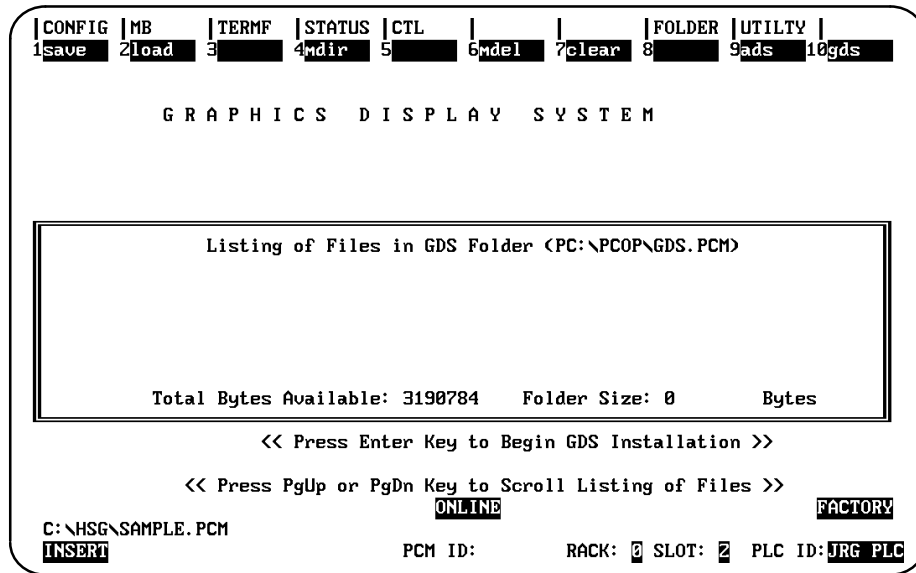

Press the Enter key to begin GDS installation.

Note

CIMPLICITY-70 GDS software is purchased separately from PCOP. For more information on the CIMPLICITY-70 Graphics Display System, refer to the *CIMPLICITY-70 Graphics Display System User's Manual*, GFK-0534.

Chapter 4

Using PCOP to Configure the PCM

This chapter explains how to use PCOP to create local user configurations. It contains information on:

- The configuration editor.
- The Edit Configuration Data menu.
- Configuration data.
- Help text.

This chapter contains the following sections:

Section 1. Configuration Editor: describes the configuration editor and the configuration data which is used to configure the PCM.

Section 2. Edit Configuration Data Menu: describes the Edit Configuration Data menu, how to access the menu, and its format. An explanation of the Help text is also included.

Section 3. Standard Configuration Functions: provides information on the standard configuration functions, which are available from the Edit Configuration Data menu.

Section 4. Advanced Configuration Functions: provides information on the advanced configuration functions, which are available from the Edit Configuration Data menu.

Section 1: Configuration Editor

Configuration data is used to configure the PCM. There are three sources of local configuration data used in the Programmable Coprocessor Module:

Configuration	Description
User Configuration Data	UCDF is a user configuration that you load into the PCM's battery-backed RAM memory. User configuration identifies the configuration used for normal operation and execution of the PCM application. User configuration data is used to: <ul style="list-style-type: none"> • Specify the configuration of the PCM to be used during the power-up sequence. • Initialize the hardware on the PCM. • Specify the user or system tasks to be started, including MegaBasic programs or CCM.
Factory Default Configuration Data	FCDF provides the minimum amount of configuration data needed to interact with the programmer and/or run MegaBasic. By default, the serial ports are set up as described in this section, with the programmer and MegaBasic connected to port 1.
Current Configuration Data	CCDF contains changes that have occurred in the configuration under user program or PCOP control. It is also referred to as active or temporary configuration.

Each has an associated checksum to guarantee the integrity of its data.

Configuration may also be supplied externally to the PCM through a Logicmaster 90 configuration or by autoconfig in the Series 90-30 PLC, which supplies a configuration equivalent to the Logicmaster 90 default configuration. Generally, Logicmaster 90 or local PCM configuration is used, but not both. For more information on Logicmaster 90 configuration, refer to the *Series 90 Programmable Coprocessor Module and Support Software User's Manual*, GFK-0255.

The configuration editor in PCOP allows you to edit configuration data files in either Off-Line or On-Line mode.

For more information on the content of the configuration data and the assigned default values, refer to appendix B, *Configuration Data*.

Section 2: Edit Configuration Data Menu

The configuration editor is used to edit user configuration data. Configuration selections are displayed on the Edit Configuration Data menu, shown below, by pressing the CONFIG (F1) softkey from the PCOP main menu. These selections are available in either On-Line or No Comm mode. All data is initialized to the default values or to the previous user configuration, if one exists in the folder.

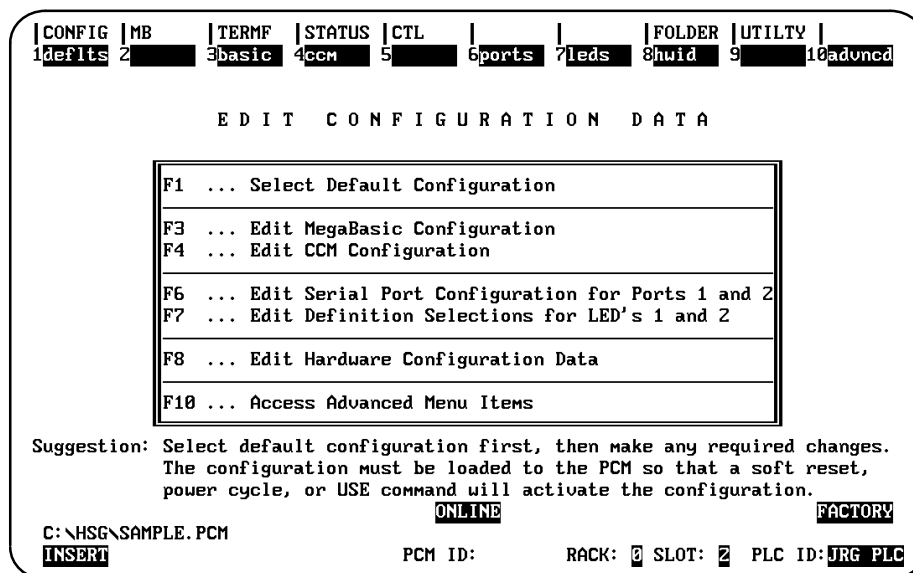

Use the function keys highlighted at the top of this screen to select configuration functions.

Function Key	Function	Description
F1	Defaults	Display the Default Configuration Data menu. This menu is used to select a default initialization for the user configuration data.
F3	Basic	Display the MegaBasic Data screen. This screen is used to enable/disable and configure the MegaBasic task and program.
F4	CCM	Display the CCM screen. This screen contains data specific to the resident CCM task. The CCM command will access the CCM Configuration screen for port 1, which contains a selection for port 2. In order for CCM to function, it must be enabled on this screen or in Logicmaster 90 software, if there is no user configuration.
F6	Ports	Select parameters for the low-level serial driver on the PCM. The system will display the Port Configuration screen for port 1, which contains a selection for port 2. The values entered on the port screen may be superseded by other device drivers or installable user drivers that occupy the serial port. If CCM is chosen for a given port, the CCM selection is used on that port and the serial port configuration is not used.
F7	LEDs	Display the LED screen. This screen allows you to assign the function of the user LEDs. The LED command will access the LED Configuration screen for LED 1, which contains a selection for LED 2.
F8	Hardware	Display the Hardware Configuration Data screen. This screen allows you to change the total memory size for a Series 90-30 PCM or the daughter board size for a Series 90-70 PCM.
F10	Advanced	Display the Advanced Configuration Data menu. This menu contains additional, usually optional, selections for configuring the system tasks, such as the programmer, adding annotation, and reading/writing specified configuration files. Refer to section 4, <i>Advanced Configuration Functions</i> for more information on advanced configuration functions.

These keys can be used to move among the various fields on an editor screen:

Key	Description
Cursor and Enter	Move among the entry fields on all configuration edit screens requiring data entry. <ul style="list-style-type: none"> • The Cursor Down and Enter keys move to the next character or field. • The Cursor Up key moves to the previous character or field. • The Cursor Right key moves to the next character or field. • The Cursor Left key moves to the previous character or field.
Backspace	Delete the character to the left of the cursor position.
Delete	Delete the character at the cursor position.
Home	Return to the first data field on the page.
End	Go to the last field on the currently displayed screen.
Escape	Abort the current menu or command, and return to the previous display screen.
CTRL-BREAK	Exit PCOP.

Saving a Configuration

To save the configuration changes to a file (`PC:UCDF.CDF`), continue to press the Escape key. Before you return to the PCOP main menu, a prompt asks you whether you want to save your changes. If you press `Y`, a new `UCDF.CDF` configuration file is created with your changes. The old `UCDF.CDF` file is lost, so you may first want to rename the old `UCDF.CDF` file or write a backup file to `XXX.CDF`, where `XXX` is your selected file name. If you press `N`, no changes are made.

Caution

Before executing your request to return to the PCOP main menu, the system prompts you for confirmation if the configuration data has been changed since the last time it was saved. If you type `N` (No), all changes made since the last save are lost.

Screen Definitions

The following information appears at the bottom of the screen on all configuration editor screens. Some of the fields, however, are only available in On-Line mode.

Field	Description
ONLINE/NOCOMM	Indicates whether PCOP and the configuration editor are currently attached to the PCM. If they are, ONLINE is highlighted; otherwise, NO COMM is highlighted. The transition from On-Line to No Comm mode (or No Comm to On-Line) may take up to 15 seconds.
PCM ID	Name of the PCM board supplied by the user configuration data, if any. If there is none, this field is blank.
Rack, Slot, CPU ID	The information displayed in these fields is supplied from the backplane and/or the power-up information supplied by the CPU.

Help Text

Help text provides a concise list of information about keys used to move between fields and screens, and to select values. Press ALT-H on any configuration editor screen to access Help text.

Key	Description
<u>Cursor Movement Keys</u>	
Left, Right Up, Down Enter Home End	Move the cursor one character in a field. Move to the previous or next field. Move to the next field, ENTER command. Return to the first edit field. Move to the last edit field.
<u>Data Editing Keys</u>	
Backspace Delete Tab or +, Shift-Tab or - ALT-J ALT-A ALT-H	Delete the previous character. Erase the current character. Increment or decrement the select field values. Toggle between expert and novice modes. Abort the active command (valid in expert mode). This help screen.

Press any key to exit the Help screen and continue editing.

Select Field

A select field, on any configuration editor screen, is a field with more than one standard value. The standard values are displayed in successive order in the select field. Use the Tab and Shift/Tab keys to scroll through the values.

For example, the Turnaround Delay field, shown on the CCM screen, displays the word NONE initially. Use the Tab and Shift/Tab keys to scroll through the values for this field. When the correct value is displayed, move to the next field or to another screen.

Section 3: Standard Configuration Functions

The following standard configuration functions are available from the Edit Configuration Data menu:

Function Key	Function	Description
F1	Defaults	Select the default configuration.
F3	Basic	Edit a MegaBasic configuration.
F4	CCM	Edit the CCM configuration.
F6	Ports	Edit the serial port configuration for ports 1 and 2.
F7	LEDs	Edit the definition selections for LEDs 1 and 2.
F8	Hardware	Change the total memory size for a Series 90-30 PCM or the daughter board size for a Series 90-70 PCM.
F10	Advanced	Access advanced menu items. For information on advanced menu selections, refer to section 4, <i>Advanced Configuration Functions</i> .

Default Configuration Data

To display the Default Configuration Data menu, press the DEFLTS (F1) softkey from the Edit Configuration Data menu (see section 2, *Edit Configuration Data Menu*).

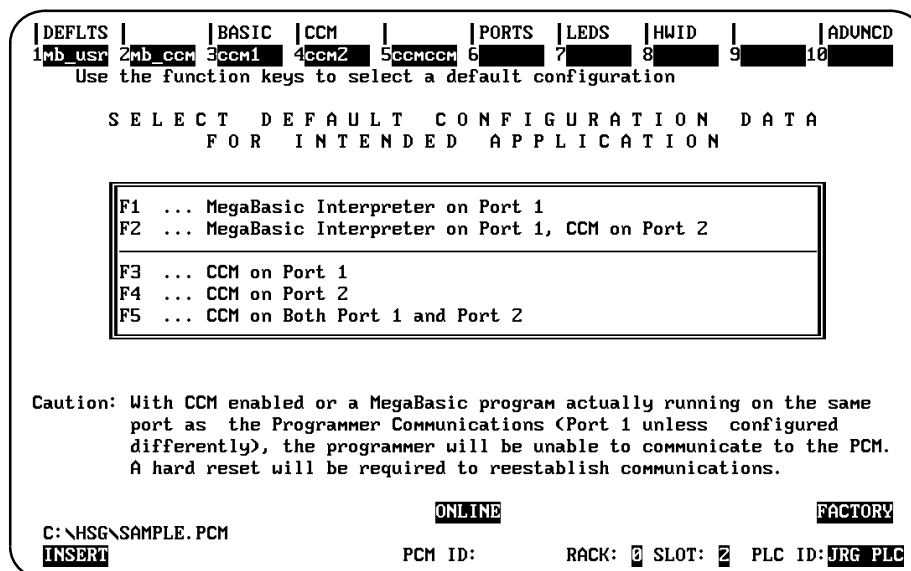

Then, press one of the function keys (F1, F2, F3, F4, or F5) to select the default values for your configuration. This initializes the configuration data to the default values for your application.

The default values are best for most applications. A good rule of thumb is to change as few values as possible to customize the PCM for your application.

Note

A specific file name can be used as the source or destination for the configuration data. Refer to section 4, *Advanced Configuration Functions*, for information on the **WRITE** and **READ** commands.

Press the Escape key to return to the Edit Configuration Data menu.

Hardware Configuration Data

To display the Hardware Configuration Data screen, press the HWID (F8) softkey from the Edit Configuration Data menu.

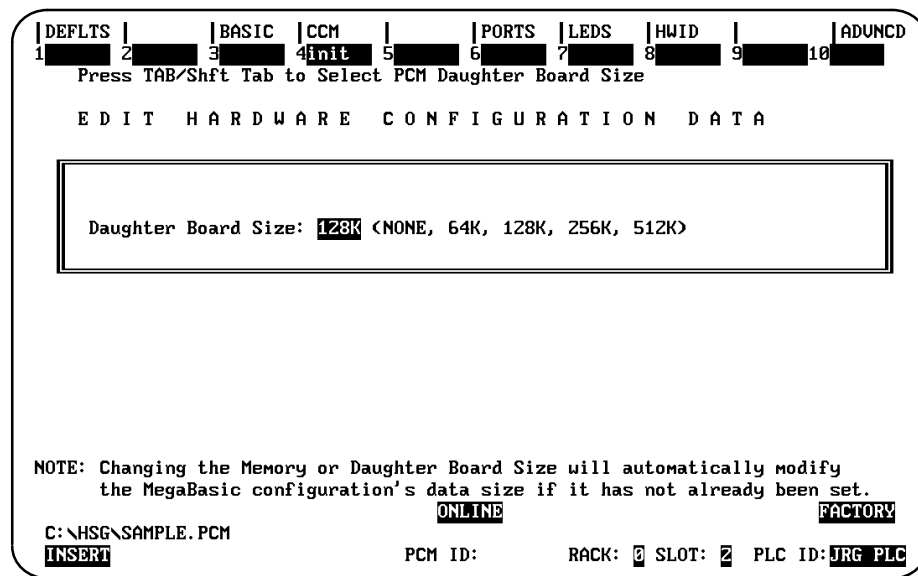

In Off-Line mode, PCOP uses a setting in TERM.DAT to determine whether a Series 90-30 or Series 90-70 PCM will be attached. (Default = Series 90-70 PCM.) If a different PCM type is actually attached, a warning that the type of PCM has changed is displayed during power-up.

The **TotalMemorySize** field is displayed for a Series 90-30 PCM (default = 192K). For the Series 90-70 PCM, the **DaughterBoardSize** field is displayed (default = 128K). Only one of these fields is present at any one time.

If this is a MegaBasic configuration, the daughter board size or total RAM size is used to give a default memory size to the MegaBasic task. When editing configuration data, set the daughter board size or total RAM size before configuring MegaBasic to ensure that enough memory is allocated to the MegaBasic task.

Refer to these definitions when completing the entries on the MegaBasic Interpreter Task screen:

Field	Description
Enable MegaBasic Task	Enable or disable the MegaBasic task.
Start MB Task on Soft Reset	This selection will cause the MegaBasic interpreter to run automatically after a power cycle or soft reset. If MegaBasic is set to start automatically after a power cycle or soft reset, the programmer is normally detached from the port. PCOP cannot communicate in USER or LM CFG configuration mode.
Program to Run at Reset ¹	Enter the program file name in this field in order to automatically start a MegaBasic program after a soft reset. This will cause your program to run without user intervention. You may also have MegaBasic automatically load the program upon invoking MegaBasic, even if MegaBasic is not started on reset. Or, you may have MegaBasic started without a program to run. In these two cases, some action by the user is required in order to execute the application.
User Program I/O ^{1,2}	The Input/Output/Error fields have a fixed number of selections: COM1:, COM2:, RAM:, PC:, and NULL:. For RAM: and PC:, you must also enter the file name (fn) on that device. Set the Input and Output for MegaBasic to the devices that the program input and output should go to by default. For example, if the programmer is attached to PCM port 1 and running TERMF program output is displayed on your screen if the output is set to COM1:. The user program may open other devices for input and output in addition to the standard I/O devices.
Task Priority	Default task priority for the MegaBasic interpreter, also known as the task number. <u>Most users do not need to change this value.</u>
MegaBasic Command Line	This field is normally used for parameters for the user MegaBasic application. Any valid RUN command line entries, except /B for background, may also be chosen for this field.
Allocated Data Size	Size, in bytes, of memory allocated to the MegaBasic task. This value is entered as a decimal integer. For the Series 90-70 PCM, the default value is based on the selected option daughter board size. For the Series 90-30 PCM, the default value is based on the selected total memory size. For more information on MegaBasic program and data size, refer to the <i>Series 90 Programmable Coprocessor Module and Support Software User's Manual</i> , GFK-0255.

¹ When the MegaBasic program will start on reset and the standard I/O is set to the programming port, the programmer is inaccessible (PCOP displays NO COMM). If you will use a different device than COM1: for MegaBasic I/O, change the I/O devices first and then select the program to run on reset.

² If you change values on this screen so that the programmer is disconnected or may be disconnected (e.g., by selecting the MegaBasic task to start running on reset with any input/output/error on COM1:), you will be informed that the programmer has been disabled. If you later remove all input/output/error from COM1:, PCOP will ask if you want the programmer reconnected.

Configuring a PCM for MegaBasic Programs

The following procedure describes how to start up the MegaBasic interpreter on a soft reset or power cycle, load a program automatically into MegaBasic, and run it without the programmer attached or without any user intervention.

1. Develop a program in MegaBasic.
2. Save the program, preferably with the file name **BASIC.PGM**, to the PCM RAM Disk (the default device) before exiting the MegaBasic interpreter. Otherwise, your work is lost. The file should also be saved to PC: to provide a backup copy.
3. When you are satisfied with the program, exit MegaBasic by typing **BYE** and re-enter PCOP.
4. Edit configuration data for MegaBasic by pressing the CONFIG (F1) softkey from the PCOP main menu.
5. Press the DEFLT5 (F1) softkey and then the MegaBasic Interpreter on Port 1 (F1) softkey. Then, press the Escape key.
6. Set the daughter board size for a Series 90-70 PCM or the total memory size for a Series 90-30 PCM before configuring MegaBasic to ensure that enough memory is allocated to the MegaBasic task. The default daughter board size is 128K. The default Series 90-30 PCM memory size is 192K. This is done on the Hardware Configuration Data screen (F8). For more information on MegaBasic program and data sizes, refer to the *Series 90 Programmable Coprocessor Module and Support Software User's Manual*, GFK-0255.
7. Press the Edit MegaBasic Configuration (F3) softkey from the Edit Configuration Data menu to display the Edit MegaBasic Configuration Data screen. Verify that MegaBasic is enabled. The program file name to run should be RAM:fn, where fn is the file name you specified when you saved the program to the PCM RAM Disk.
8. **Start MB on Soft Reset** should be selected as **YES**. Change any other configuration parameters required for the application.
9. Press the Escape key to return to the Edit Configuration Data menu. Then, press the Escape key to save the configuration data. Respond to the prompt by typing **Y**.
10. Press the Select Utility Functions (F9) softkey, and then press Load (F2). Select **CONFIGURATION** so that the configuration data that was just saved by the PCOP configuration editor is loaded to the PCM.
11. When the load is completed, exit PCOP and disconnect the PCM from the programmer. Attach any output devices required by the application. Note that the programmer may be used as a terminal at this point by entering TERM or TERMF, either from PCOP or MS-DOS.
12. Press the Restart/Reset pushbutton for less than 5 seconds to initiate a soft reset. The program will begin running.
13. A hard reset (pressing and holding the Restart/Reset pushbutton for more than 5 seconds) will stop the program.

To configure CCM on port 2, press the PORT 2 (F2) softkey.

```

DEFLTS | BASIC | CCM | PORTS | LEDS | HWID | ADUNCD
1port 1 2port 2 3 4init 5 6 7 8 9 10nxtpg
Press TAB/Shft TAB to Select Enable/Disable CCM on this Port

EDIT CCM CONFIGURATION DATA FOR PORT 2

Enable CCM on Port: NO <YES, NO>      CCM CPU ID: 1 <1..254>
Mode: SLAVE <SLAVE, MASTER, PEER>
Turnaround Delay: NONE <NONE, 10ms, 100ms, 500ms, OTHER>
Timeout: LONG <LONG, MEDIUM, SHORT, NONE, OTHER>
Retry Count: NORMAL <NORMAL, SHORT, OTHER>

Interface: RS232 <RS-232, RS-485>
Data Rate: 19200 bps <300, 600, 1200, 2400, 4800, 9600, 19200>
Parity: ODD <ODD, NONE>
Flow Control: NONE <NONE, HARDWARE>

*** ADVANCED CONTROL PARAMETERS ***
Priority: 0

CAUTION: Enabling CCM Will Disable Programmer COMM and MB on this Port on Reset
ONLINE FACTORY
C:\HSG\SAMPLE.PCM
INSERT PCM ID: RACK: 0 SLOT: 2 PLC ID: JRG PLC
  
```

Refer to the following definitions when completing the entries on the Edit CCM Configuration Data screen. For select fields, use the Tab and Shift/Tab keys to scroll through the list of selections.

The default value for the port 2 hardware interface for the Series 90-30 PCM is RS-232 for the 32K, 192K and 640K PCMs. The 160K Series 90-30 PCM port 2 value is fixed at RS-485.

Field	Description
Enable CCM Task on Port	<p>If CCM is enabled on the same port as the programmer or MegaBasic, the system will prompt you to disable MB and set the programmer devices to NULL.</p> <p>To access other fields on this screen, set this field to YES. If NO is selected, CCM is not enabled. (Default = NO)</p>
CCM CPU ID	This field identifies CCM on this PCM serial port.
Mode	The choices for this field are PEER , MASTER , or SLAVE .
Turnaround Delay, Timeout, Retry Count	<p>These are all select fields. You may select a standard value, or enter a non-standard value on the detail screen. Press the NXTPG (F10) softkey to view standard values or enter non-standard values.</p> <ul style="list-style-type: none"> • Choices for Timeout are LONG, MEDIUM, SHORT, NONE, or OTHER. • Choices for Retry Count are NORMAL, SHORT or OTHER. • Choices for Turnaround Delay are NONE, 10 ms, 100 ms, 500 ms, or OTHER. <p>If standard values are selected for any of these fields, those values are automatically entered on the Detail Data screen. If OTHER is selected, the values must be entered on the Detail Data screen. If a standard value is changed on the Detail Data screen, the selection on the Edit CCM Configuration Data menu automatically changes to OTHER.</p> <p>For more information on turnaround delays, timeouts, and retry counts, refer to the <i>Series Six Programmable Controllers Data Communications Manual</i>, GEK-25364.</p>
Interface	Hardware interface to be used on this CCM port. Choices are RS-232 and RS-485 . This field is not displayed for port 1 of a Series 90-30 PCM or port 2 of a 160K Series 90-30 PCM.
Data Rate, Parity, Flow Control	<p>These are all select fields. Choices for data rate are 300, 600, 1200, 2400, 4800, 9600, and 19,200. 38,400 is also available in RS-485 mode only.</p> <p>Parity may be ODD or NONE.</p> <p>Selections for flow control are NONE and HARDWARE</p>
Task Priority	This field allows you to assign priorities for the CCM task(s). Most users, however, should not change this value.

Caution

Changes in system task priority may seriously affect overall performance.

CCM Detail Data

When the NXXTPG (F10) softkey is pressed from the Edit CCM Configuration Data screen, the Edit CCM Configuration Detailed Data screen is displayed. This screen is used to display the values associated with the standard selections made on the Edit CCM Configuration Data screen. Non-standard values for the CCM protocol task data may also be entered here. If a standard value is changed on this screen, the selection for that table on the Edit CCM Configuration Data screen is automatically updated to OTHER.

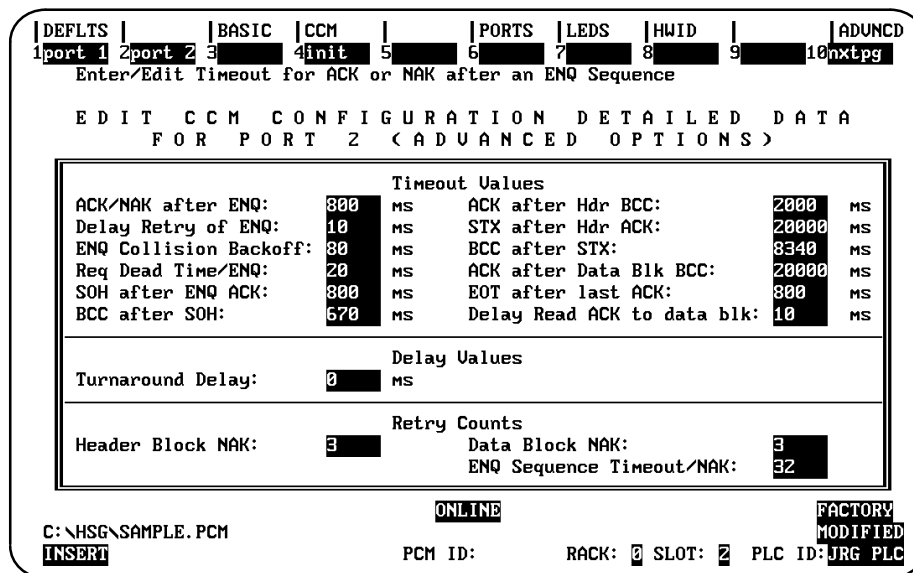

To change the value of an entry on this screen, move the cursor to that entry and enter the new value.

Valid ranges for the configuration data on this screen are 0 through 65,535 in milliseconds for timeout values and turnaround delay, and in counts for retry counts.

Press the NXXTPG (F10) softkey to return to the CCM Configuration Data screen, or press the Escape key to return to the Edit Configuration Data menu.

Serial Port Initialization Data

To display the Serial Port Data screen for port 1, press the PORTS (F6) softkey from the Edit Configuration Data menu.

```
DEFLTS | port 1 | port 2 | 3 | 4init | 5 | 6 | 7 | 8 | 9 | 10 | ADUNCD
Press TAB/Shft TAB to Select Hardware Interface for this Port

      EDIT SERIAL PORT 1 (COM1:)
      CONFIGURATION DATA

Interface: RS232 (RS-232, RS-485)
Data Rate: 19200 (300, 600, 1200, 2400, 4800, 9600, 19200, 38400)
Parity: NONE (ODD, EVEN, NONE)
Flow Control: HARDWARE (NONE, HARDWARE, SOFTWARE)

Stop Bits: 1 (1, 2)
Bits/Char: 8 (7, 8)

CAUTION: This Data is IGNORED if CCM is Enabled on This Port

C:\HSG\SAMPLE.PCM          ONLINE          FACTORY
INSERT                    PCM ID:        RACK: 0 SLOT: 2 PLC ID: JRG PLC
MODIFIED
```

Press F2 for port 2.

```
DEFLTS | port 1 | port 2 | 3 | 4init | 5 | 6 | 7 | 8 | 9 | 10 | ADUNCD
Press TAB/Shft TAB to Select Hardware Interface for this Port

      EDIT SERIAL PORT 2 (COM2:)
      CONFIGURATION DATA

Interface: RS232 (RS-232, RS-485)
Data Rate: 19200 (300, 600, 1200, 2400, 4800, 9600, 19200, 38400)
Parity: NONE (ODD, EVEN, NONE)
Flow Control: HARDWARE (NONE, HARDWARE, SOFTWARE)

Stop Bits: 1 (1, 2)
Bits/Char: 8 (7, 8)

CAUTION: This Data is IGNORED if CCM is Enabled on This Port

C:\HSG\SAMPLE.PCM          ONLINE          FACTORY
INSERT                    PCM ID:        RACK: 0 SLOT: 2 PLC ID: JRG PLC
MODIFIED
```

Values are not required on this screen if the port is to be used by CCM. If values are placed here under those conditions, they are not used at initialization time.

When the port has been selected for use by MegaBasic or the programmer, values may be entered for the port setup on this screen. If no user entries are made, the default settings are used.

The default value for the port 2 hardware interface for the Series 90-30 PCM is RS-232 for the 32K, 192K and 640K PCM. The 160K Series 90-30 PCM port 2 value is fixed at RS-485.

Refer to the following definitions when completing the entries on the Serial Port Data screen. For select fields, use the Tab and Shift/Tab keys to scroll through the list of selections.

Field	Description
Interface	The hardware interface standard to be used on this port. The choices are RS-232* and RS-485 . The hardware interface selection is not available for port 1 of the Series 90-30 PCM or port 2 of the Series 90-30 PCM with 160K memory.
Data Rate	The values of this field range from 300 to 38,400. (Default = 19,200 bps) 38,400 is only permitted in RS-485 mode. Standard selections are listed in the select entries.
Parity	Type of parity to be used. Choices are NONE* , ODD , or EVEN .
Flow Control	Type of flow control to be used. Choices are HARDWARE* , SOFTWARE , or NONE . If this is the file server port, hardware flow control is strongly recommended. Do not use software flow control for the file server port. Be careful to select the proper flow control for the device (including OITs and printers) that you intend to attach to each port. Improper flow control can cause either the PCM or the attached device to appear to hang up, or any operation to fail or appear not to work.
Stop Bits	Number of stop bits. Choices are 1* or 2 .
Bits per Character	Number of bits per character for data transfer. Choices are 7 or 8* . 8 must be used for the file server port.

* Default selection.

Redefining the User LEDs

Assignments for the user LEDs can be redefined by pressing the LEDS (F7) softkey from the Edit Configuration Data menu. The User LED Definition Attributes screen for LED 1 is displayed.

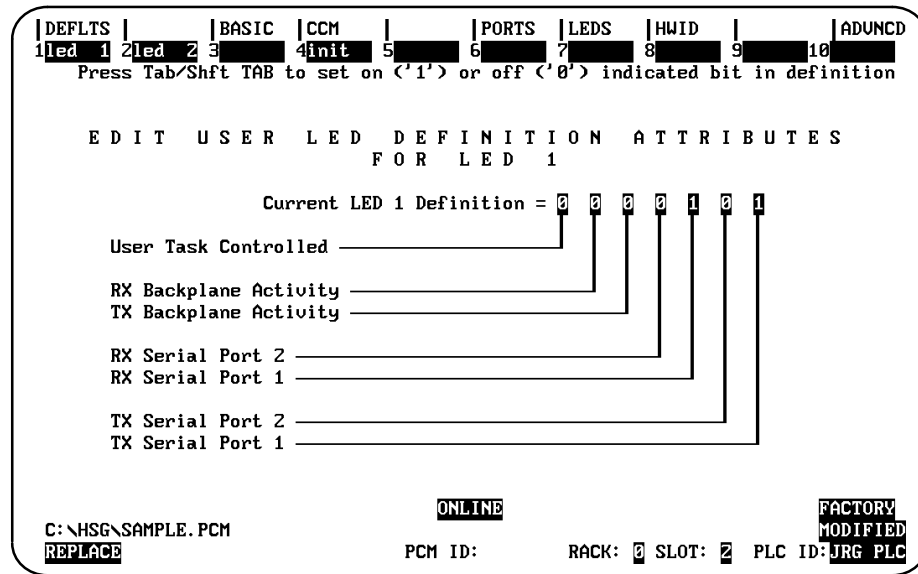

Press the LED 2 (F2) softkey from the User LED Definition Attributes screen to display the User LED definition attributes for LED 2.

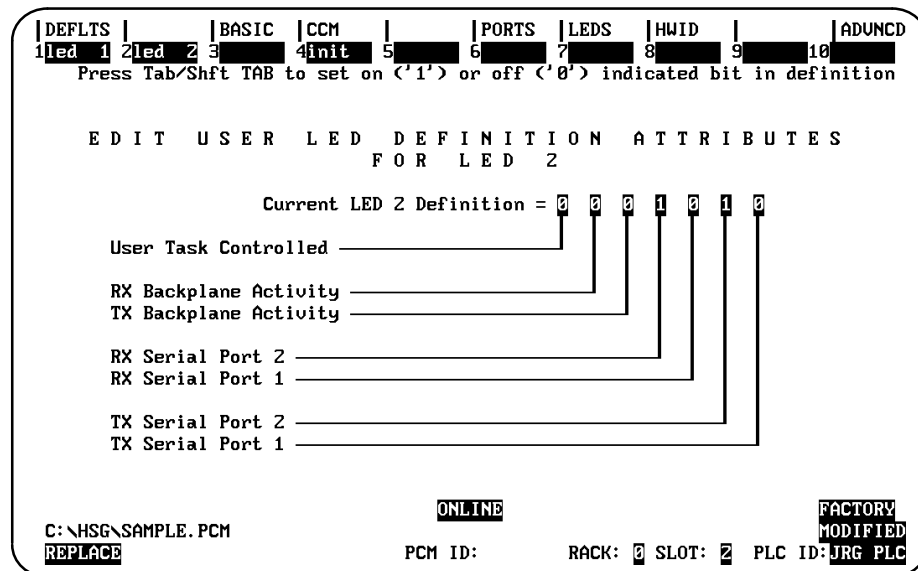

The default definition of each LED is displayed on the screens shown above. To select or deselect an attribute, cursor to the desired attribute and press the Tab key to toggle the bit. A 1 means the attribute is enabled; a 0 means it is disabled. Multiple attributes may be chosen for each LED.

When the user task is chosen, the task number that will control the LED must be entered at the prompt. The task number is the same as the task priority.

Section 4: Advanced Configuration Functions

The following advanced configuration functions are available from the Advanced Configuration Data menu:

Function Key	Function	Description
F1	System Task	Edit programmer communications and file server data.
F7	Comment	Edit annotation describing the configuration data.
F8	Read Configuration	Read configuration data from a file.
F9	Write Configuration	Write configuration data to a file.
F10	Standard	Access standard menu items.

To access these advanced configuration functions, press the ADVNCD (F10) softkey from the Edit Configuration Data menu (see section 2, *Edit Configuration Data Menu*). Press F10 again to return to the standard menu items.

For information on the standard menu selections, please refer to section 3, *Standard Configuration Functions*.

Programmer Communications and File Server Data

To display the Programmer Communications and File Server Data screen, press F1 from the Advanced Configuration Data menu.

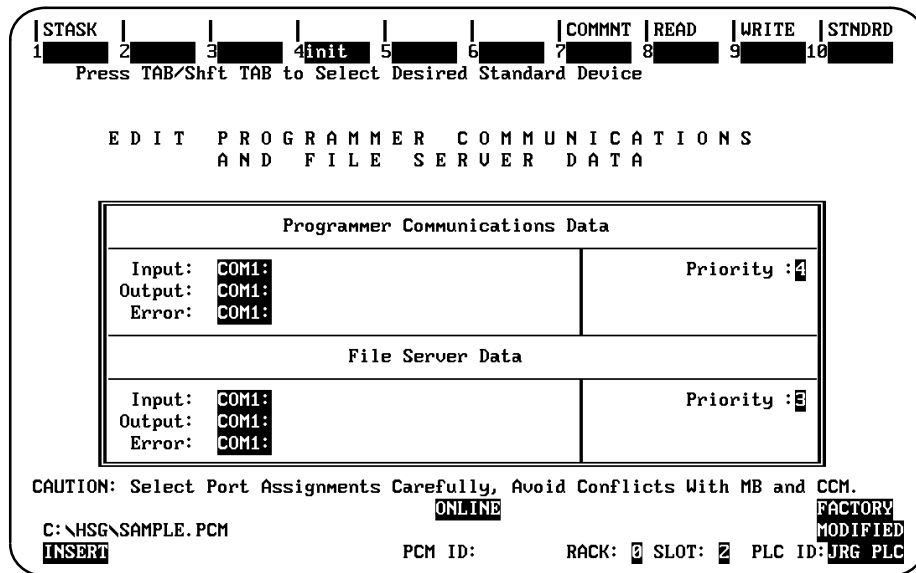

The only configuration items allowed for programmer and file server are Task Priority and the Standard In/Out/Error devices.

Field	Description
Priority	This field is displayed with the default system programmer or file server task priority. Do not enter zero in this field. <i>Changes in task priority may seriously affect overall performance. Most users should not change this value.</i>
I/O Devices	The Standard In/Out/Error fields have a fixed number of choices for the standard device names, accessed by pressing the Tab key. For the programmer, the possible selections include COM1: , COM2: , RAM: , PC: , and NULL: . For PC: and RAM: , you must also enter the file name on that device. For file server, the selections include COM1: and COM2: .

When the MegaBasic program is configured to start on reset and the standard I/O for MegaBasic is set to the programmer port, the programmer I/O is set to NULL:. If you plan to use a different device than COM1: for MegaBasic I/O, change the MegaBasic and programmer I/O devices first and then specify the program to run on reset. If you want the programmer to run on port 2, select COM2: on this screen.

If you change values on this page so that the programmer is or may be disconnected (i.e., by selecting the MegaBasic task to start running on reset with any of its standard I/O channels (input, output, or error) assigned to COM1:, you must confirm this configuration. If you later remove all other input/output/error from COM1:, PCOP will ask if you want the programmer reconnected.

Commentary Data

Press the COMMNT (F7) softkey from the Advanced Configuration Data menu to display the Edit Annotation Describing the Configuration Data screen.

```

|STASK | 2 | 3 | 4init | 5 | 6 | COMMNT | READ | WRITE | STNDRD
1 | 2 | 3 | 4 | 5 | 6 | 7 | 8 | 9 | 10
Enter/Edit Name for the PCM Module

      E D I T   A N N O T A T I O N   D E S C R I B I N G   T H E
      C O N F I G U R A T I O N   D A T A

PCM id: 
Comment:
Earliest PCM S/W Revision: 2.0 (ANY, 2.0)

C:\HSG\SAMPLE.PCM          ONLINE          FACTORY
INSERT                    PCM ID:          RACK: 0  SLOT: 2  PLC ID: JRG PLC
  
```

Note

None of the fields displayed on this screen requires an entry.

Field	Description
PCM ID	A 7-character or smaller user name for the configuration specified by the file being edited. This field allows you to identify this configuration after it has been loaded to a PCM; however, it does not require an entry. If no name is entered, the field is blank on all Config Edit and PCOP screens.
Comment	This field may contain any information which allows further identification of the particular configuration. The maximum length of this field is 183 characters.
Earliest PCM S/W Revision	The lowest software release number required to support both this configuration and the user software and options specified in it. If no particular software revision is required, select ANY . Software revision is not checked during configuration at this time.

Press the Escape key to return to the Advanced Configuration Data menu.

Read Configuration Data

To display the Read Configuration Data screen, press the READ (F8) softkey from the Advanced Configuration Data menu.

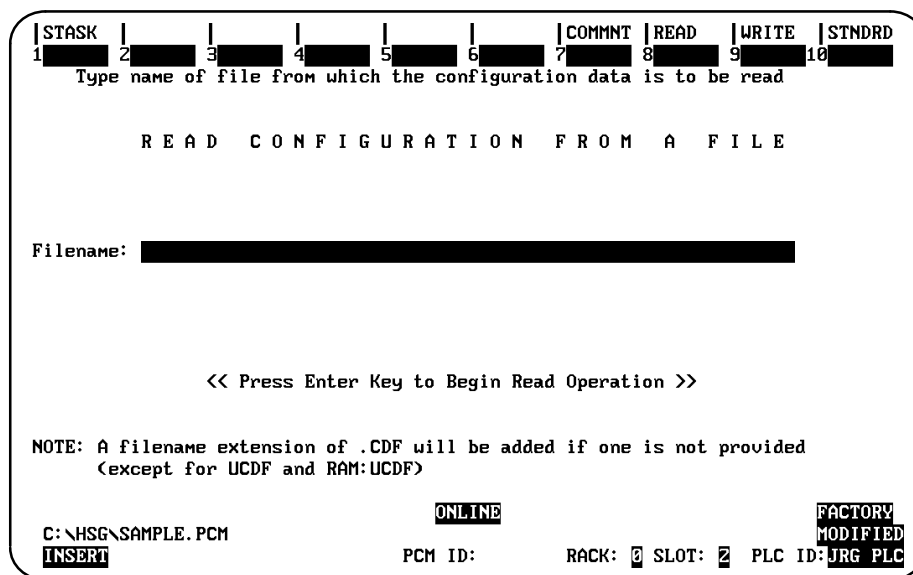

Enter the name of the file from which the configuration data is to be read. Then, press the Enter key to begin the read operation.

Using the read and write configuration data functions is the only way to maintain multiple (different) configurations in the same folder. Otherwise, the configuration file UCDF.CDF will have only the most recent configuration parameters. UCDF.CDF is the file that is saved to the folder on the hard disk when leaving the editor. It is also loaded to the PCM by the Load Config utility.

Each file may have a unique name by which the system identifies it. The name you give a configuration can be any valid MS-DOS file name, and it may include a path. It is recommended, however, that you use file names with an extension of .CDF. This name is used to identify the configuration data and other data associated with it. A file name without an extension will automatically be given the extension .CDF.

Note

Do not begin a file name with any of the following: AUX, COMx, CON, or LPTx. These have special meanings to the MS-DOS operating system. Other reserved file names include: UCDF, UCDF.CFG, LIST.CFG, *.ENV, *.DAT, *.SYS, and _* (leading underscore character in the file name). In addition, do not use the wildcard characters * or ? as part of a file name.

Write Configuration Data

To display the Write Configuration Data screen, press the WRITE (F9) softkey from the Advanced Configuration Data menu.

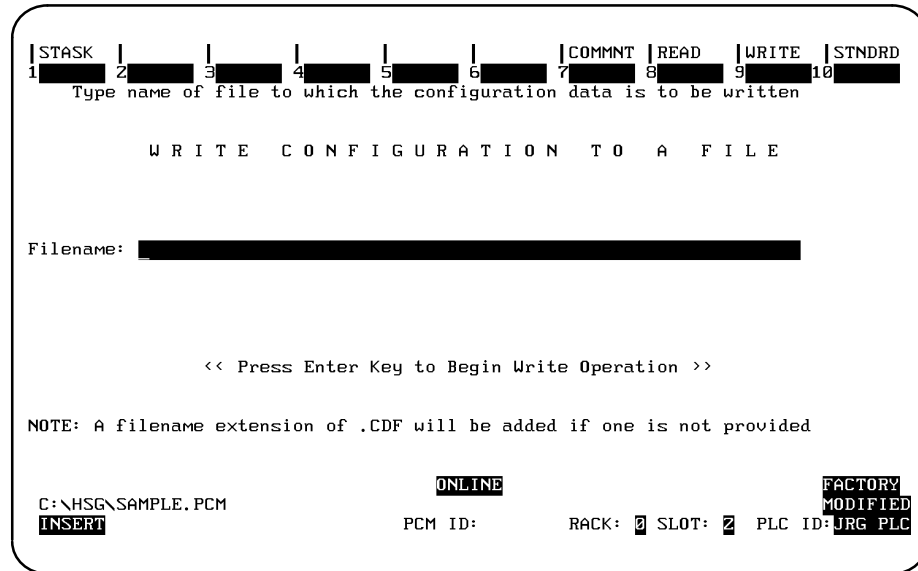

Enter the name of the file to which the configuration data is to be written. Then, press the Enter key to begin the write operation.

Using the read and write configuration data functions is the only way to maintain multiple (different) configurations in the same folder. Otherwise, the configuration file **UCDF.CDF** will have only the most recent configuration parameters. **UCDF.CDF** is the file that is saved to the folder on the hard disk when leaving the editor. It is also loaded to the PCM by the Load Config utility.

Each file may have a unique name by which the system identifies it. The name you give a configuration can be any valid MS-DOS file name, and it may include a path. It is recommended, however, that you use file names with an extension of **.CDF**. This name is used to identify the configuration data and other data associated with it. A file name without an extension will automatically be given the extension **.CDF**.

Note

Do not begin a file name with any of the following: AUX, COMx, CON, or LPTx. These have special meanings to the MS-DOS operating system. Other reserved file names include: UCDF, UCDF.CFG, LIST.CFG, *.ENV, *.DAT, *.SYS, and **_*** (leading underscore character in the file name). In addition, do not use the wildcard characters ***** or **?** as part of a file name.

Chapter 5

Using PCOP in Expert Mode

Expert mode in PCOP provides shortcuts for entering commands. This mode uses fewer keystrokes than when using the menu function softkeys.

PCOP starts up in non-expert mode. Expert mode may be selected at any time by pressing ALT-J. ALT-J functions as a toggle key between expert and non-expert mode. To return to non-expert mode, simply press ALT-J again.

In expert mode, commands are entered on the command line at the ">" prompt instead of, or in addition to, using the function softkeys. The command line, which only appears on the display screen in expert mode, contains the ">" prompt and a cursor, and is located below the message line on the screen. In non-expert mode, the ">" prompt and cursor are not displayed on the command line.

The commands for expert mode are the same as the function softkey names on each screen or menu. Only the first three characters of a command are significant and must be entered. Additional characters may be entered, but they are ignored. The commands which may be entered on any screen are not limited to just those function softkeys displayed on a particular screen. The Space Bar and Enter keys are used to indicate completion of the current command or parameter.

Parameters for each command, if any, are prompted for on the message line in a specific order. Read the prompt carefully and respond to each question. Information about the command format of each command is included on the following pages in this chapter.

While you are in the configuration editor in expert mode, you can use the cursor and Enter keys to move from the command line to the other fields on each screen. However, expert mode commands can be entered only when the cursor is on the command line. When you have completed the entries on a screen, cursor back to the command line.

PCOP expert mode commands do not support using the cursor keys to move to a field on the screen. You must toggle back to non-expert mode to move off the command line when using PCOP commands.

Some commands are only available in On-Line mode. If one of these commands is entered in Off-Line mode, an "Invalid Command" message is displayed.

Other commands are only available inside the configuration editor (referred to as **CONFIG** commands) or outside the editor (referred to as PCOP commands). If a **CONFIG** command is initiated outside of the configuration editor, or vice versa, an "Invalid Command" message is displayed. All expert mode commands in the editor are menu shortcut commands, except for the **READ**, **WRITE**, and **EXIT** commands. The validity (On-Line mode and PCOP vs. CONFIG) of each command is included in the description of each command in this chapter.

After an expert mode command is completed, it is not automatically reactivated. For example, after typing `LOAD MY.PGM`, you are still on the Load screen. However, in order to load another file, you must enter the command again (e.g., `LOAD MY2.PGM`).

ADS

The `ADS` command is used to initially install the CIMPPLICITY 90-ADS software or to change the executable environment of the CIMPPLICITY 90-ADS software. This command automatically performs a soft reset and establishes the PC: drive as the current folder directory. The ADS software screen is only available in On-Line mode.

The format of the `ADS` command is:

`ADS D`

or

`ADS E sn tt pt`

D	Development.
E	Execute only. When Execute only is selected, you must also supply the system name, terminaltable, and printer table.
sn	System name.
tt	Terminaltable.
pt	Printer table.

For more information on the `ADS` command, refer to chapter 3, section 7, *Program Utility Functions*.

Note

CIMPPLICITY 90-ADS software is purchased separately from PCOP. It requires an Alphanumeric Display Coprocessor Module in order to use the software. For more information on the CIMPPLICITY 90-ADS system, refer to the *CIMPPLICITY 90-ADS User's Manual*, GFK-0499.

Command Restriction: PCOP, ONLINE.

ADV

The Advance (**ADV**) command is used to display the Advanced Configuration Data menu in the configuration editor. This menu contains additional, though usually optional, selections for configuring the system tasks, such as the programmer, adding annotation, and reading/writing specified configuration files.

To display this menu, type **adv** on the command line and press the Enter key.

For more information on the **ADV** command, refer to chapter 4, section 4, *Advanced Configuration Functions*.

Command Restriction: CONFIG.

BASIC

The **BASIC** command is used to display the MegaBasic Data screen. This screen is used to enable/disable MegaBasic and to configure the MegaBasic task and program.

To display the Edit MegaBasic Data screen, type **bas** and press the Enter key. Then, complete the entries on the screen.

Refer to chapter 4, section 3, *Standard Configuration Functions*, for an explanation of the entries on this screen.

Command Restriction: CONFIG.

CCM

The **CCM** command is used to display the Edit CCM Configuration Data screen for CCM 1 on port 1. You can use the Tab key to toggle between CCM 1 (port 1) and CCM 2 (port 2).

The format of the **CCM** command is:

CCM [**pn**]

where [**pn**] represents the CCM port number (1 or 2). For example, to go to the CCM screen for port 2 from anywhere in the configuration editor, type **ccm** and press the Enter key. Then, type **2** and press the Enter key to select port 2.

The fields on this screen contain default values. Refer to chapter 4, section 3, *Standard Configuration Functions*, for an explanation of the entries on this screen.

Command Restriction: CONFIG.

CFG and CHE

The Checksum (**CHE**) and Config (**CFG**) commands are identical. They are used to calculate the checksum and display other identifying information about specific configuration data. Checksum information can be displayed for user configuration data (UCDF) or a configuration file, as shown in the table below.

To use this command, type **che** on the command line.

The format of the **CHE** command is:

```
CHECK UCDF
```

or

```
CHECK fn
```

UCDF	The user configuration data on the PCM.
fn	A local file, or file located on the PCM RAM Disk (RAM:fn).

Command Restriction: PCOP.

CLEAR

The **CLEAR** command is used to remove any modules currently located in PCM user memory, programs, data modules, and configuration files. The Clear PCM screen is only available in On-Line mode.

Note

Using the **CLEAR** command returns the memory to its as-shipped state, with no user files or other data in user memory.

To display this screen, type **cle** on the command line. A list of the files located on the PCM is displayed in the window. Press the Enter key to complete this command. Then, press the Enter key again to clear the PCM.

For more information on the **CLEAR** command, refer to chapter 3, section 7, *Program Utility Functions*.

Command Restriction: PCOP, ONLINE.

COMMNT

The Comment (**COMMNT**) command is used to display the Edit Annotation Data screen. To display this screen, type **com** on the command line and press the Enter key. Entering data in the fields displayed on this screen is optional.

For more information on the **COMMNT** command, refer to chapter 4, section 4, *Advanced Configuration Functions*.

Command Restriction: CONFIG.

CONFIG

The Configuration (**CONFIG**) command is used to enter the PCOP configuration editor and display the Edit Configuration Data menu. This can be done in either On-Line or No Comm mode.

To use the **CONFIG** command, type **con** on the command line and press the Enter key.

For more information on the Edit Configuration Data menu, please refer to chapter 4, section 2, *Edit Configuration Data Menu*.

Command Restriction: PCOP.

CTL

Control functions are used to change the configuration mode of the PCM, start and stop user tasks, and redefine the user LEDs. The Control Functions menu is only available in On-Line mode.

To display this menu, type **ctl** on the command line and press the Enter key. Then, select the particular function you wish to perform.

For more information on control functions, refer to chapter 3, section 5, *Control Functions*.

Command Restriction: PCOP, ONLINE.

DEFLTS

The Defaults (**DEFLTS**) command is used to select various default initializations for user configuration data. To use this command, type **def** on the command line and press the Enter key. Then, select the default values for your particular configuration. Note that the configuration type must be selected using the function keys on this screen. No expert command is provided for the configuration default types.

For more information on the **DEFLTS** command, refer to chapter 4, section 3, *Standard Configuration Functions*.

Command Restriction: CONFIG.

ERRORS

The **ERRORS** command is used to display errors accumulated from the PCM while the PCOP package is attached. These errors are listed on the Error Display screen. Only the most recent eight errors are displayed. These errors are then cleared from the screen after exiting the Error Display screen.

To display this screen, type **err** on the command line and press the Enter key.

For more information on the **ERRORS** command and the Error Display screen, refer to chapter 3, section 4, *Status Display Functions*.

Command Restriction: PCOP.

EXIT

The **EXIT** command is used to terminate the PCOP session from any menu and return to MS-DOS or the Logicmaster 90 Programming Software main menu. To use this command, type **exi** on the command line and press the Enter key.

FBAKUP

The Backup Folder (**FBAKUP**) command is used to create a backup copy of the currently selected program folder. To display the Backup a Current Program Folder screen, type **fba** on the command line and press the Enter key. The name of the current folder is displayed on this screen. Press the Enter key to start the backup function.

The backup folder is located in a subdirectory under the program folder. If no backup folder exists for the current program folder, one is automatically created. If the program folder has been backed up previously, the backup function writes over the previous backup version.

Note

Multiple backups of the same program folder are not maintained.

For more information on the **FBAKUP** command, refer to chapter 3, section 6, *Program Folder Functions*.

Command Restriction: PCOP.

FCLEAR

The Clear Folder (**FCLEAR**) command is used to delete the contents of the current program folder, while keeping the folder itself for future use. If the program folder is locked, it cannot be cleared.

To display the Clear Current Program Folder screen, type **fc1** on the command line on the command line and press the Enter key. The name of the current folder is displayed on the screen. Press the Enter key to start the clear operation. If there is any information in the program folder, you must confirm this request before continuing.

For more information on the **FCLEAR** command, refer to chapter 3, section 6, *Program Folder Functions*.

Command Restriction: PCOP.

FCOPY

The Copy Folder (**FCOPY**) command is used to copy from another program folder into the current program folder. The contents of the source program folder are copied into the current program folder. If any files have the same name in the current program folder as in the source program folder, they are overwritten.

The format of the **FCOPY** command is:

```
FCO fol
```

where **fol** is the name of the program folder whose contents are to be copied into the currently selected program folder. Press the Enter key to begin the copy operation.

For more information on the **FCOPY** command, refer to chapter 3, section 6, *Program Folder Functions*.

Command Restriction: PCOP.

FDEL

The Delete Folder (**FDEL**) command is used to remove a program folder that is no longer needed. If the program folder has a backup, the backup is automatically deleted. If any directories have been created beneath the program folder to be deleted, these must be removed before using the **FDEL** command. The last remaining program folder cannot be deleted.

Note

If a program folder is locked, it cannot be deleted. You must first use the **FLOCK** command to unlock the folder.

The format of the **FDEL** command is:

```
FDE fol
```

where **fol** is the name of the program folder to be deleted. Press the Enter key again. Respond to the confirmation prompt to continue with the deletion. ***Oncestarted, the delete operation cannot be stopped.***

For more information on the **FDEL** command, refer to chapter 3, section 6, *Program Folder Functions*.

Command Restriction: PCOP.

FDIR

The Folder Directory (**FDIR**) command is used to obtain a list of the files in the current program folder. The list is displayed on the List Contents of the Current Program Folder screen. The number of bytes available on the disk and the number of bytes that are being used by the current folder are also displayed on this screen.

To display this screen, type **fdi** on the command line and press the Enter key.

If more file names are in the current folder than can be displayed on the screen at one time, use the PageUp/Page Down cursor keys to page through the file names.

For more information on the **FDIR** command, refer to chapter 3, section 6, *Program Folder Functions*.

Command Restriction: PCOP.

FOLDER

Program folder functions are used to organize program and configuration files in a common program folder. A program folder is actually a subdirectory of files.

To display the Program Folder Functions menu, type **f01** on the command line and press the Enter key. Then, select the particular function you wish to perform.

For more information on folder functions, refer to chapter 3, section 6, *Program Folder Functions*.

Command Restriction: PCOP.

FLOCK

Locking a program folder protects its files against accidental alteration or deletion. To toggle the LOCKED/UNLOCKED status of the current folder, type **f10** and press the Enter key. The new status will appear in the lower right corner of the screen.

Note

The folder lock function is not available for release 2.06 and earlier.

Command Restriction: PCOP.

FRESTR

The Restore Folder (**FRESTR**) command is used to replace the contents of the current program folder with the contents of the backup copy. In order to use this command, a backup version must already exist. If the program folder is locked, you must change the status to unlocked before restoring the program folder.

To display the Restore Current Program Folder screen, type **fre** on the on the command line and press the Enter key. The name of the current folder is displayed on the screen. Then, press the Enter key to start the restore operation.

If any information exists in the current program folder that would be written over by the backup information, you must confirm this request. ***Once started, the restore operation cannot be stopped.***

For more information on the **FRESTR** command, refer to chapter 3, section 6, *Program Folder Functions*.

Command Restriction: PCOP.

FSEL

The Select Folder (**FSEL**) command is used to create a new program folder or select one that already exists.

The format of the **FSEL** command is:

```
FSEL fol
```

where **fol** is the name of the program folder.

The names of the program folders that are in the current drawer are listed on the screen. To select a folder in another drawer, fully specify the file name with a directory.

To select a folder that does not already exist, enter the name of the new folder and press the Enter key. You must then confirm this request in order to prevent accidentally creating a program folder due to a typing mistake.

The directory created by this function will always have the extension **.PCM**. You do not need to include **.PCM** in the folder name; it is provided automatically.

For more information on the **FSEL** command, refer to chapter 3, section 6, *Program Folder Functions*.

Command Restriction: PCOP.

GDS

The **GDS** command is used to initially install the CIMPLICITY-70 Graphics Display System (GDS) software. This command automatically performs a soft reset and establishes the PC: drive as the current folder directory. The GDS screen is only available in On-Line mode.

To display this screen, type **gds** on the command line and press the Enter key.

For more information on the **GDS** command, refer to chapter 3, section 7, *Program Utility Functions*.

Note

The GDS software must be purchased separately from PCOP. For more information on the CIMPLICITY-70 Graphics Display System, refer to the *CIMPLICITY-70 Graphics Display System User's Manual*, GFK-0534.

Command Restriction: PCOP, ONLINE.

HELP

Help text provides a concise list of information about moving between fields and screens, and selecting values. To display Help text, press ALT-H on any configuration editor screen or type **hel** on the command line and press the Enter key. Press any key to exit from the Help screen and continue editing.

Command Restriction: CONFIG.

LED

LED is both a PCOP command and a CONFIG command. Outside the editor, it displays the User LED Definition Attributes screen in On-Line mode. This screen allows you to interactively and temporarily redefine the assignments of the user LEDs. Within config, the **LED** command is used to edit the configured definition of the user LEDs.

The format of the **LED** command is:

```
LED 1n
```

where **1n** is the LED number 1 or 2. The current definition of the LED is displayed. Position the cursor on the desired LED attribute, and use the Tab key to toggle the bits on and off.

Note

Changes made in the definition of the user LEDs in PCOP will also update/override the current active configuration data (but not the UCDF). All changes made using this command are lost upon reset/power cycle of the PCM. To change the user configuration (UCDF), use the configuration editor.

When the user task is chosen, the task number or number of the driver that will control the LED must be entered at the prompt. The task number is the same as the task priority.

Command Restriction: PCOP, CONFIG.

LOAD

The **LOAD** command is used to load user MegaBasic programs and configuration files from the PC file system into user memory. User programs must be loaded into the MegaBasic workspace by MegaBasic interpreter. The files may be loaded to the RAM Disk for fast access and onboard storage by using the **LOAD** command.

To use the **LOAD** command, type **load** on the command line, and press the Enter key.

The format of the **LOAD** command:

```
LOAD fn [pf] [R]
```

or

```
LOAD fn UCDF
```

fn	The name of the file to be loaded.
pf	The name of the file on the PCM RAM Disk. This is an optional parameter; if not required, simply press the Enter key in response to the prompt. If no PCM file name is entered, the PC file name is used.
UCDF	The user configuration data on the PCM.
R	Read only (protection level). This is an optional parameter; if not required, simply press the Enter key in response to the prompt. If no protection level is assigned, the module is not protected from writes.

For example, to load the standard configuration MB1.CBF to the PCM as UCDF, type:

```
Load \PCOP\MB1\UCDF
```

To load a user program called BASIC.PGM to a PCM RAM disk file called MY.PGM, type:

```
Load BASIC.PGM MY.PGM
```

Note

The UCDF module can also be loaded to the PCM by using the **USE** command, as described later in this chapter.

If the file cannot be located, the following error is displayed:

```
PCM Error, Command Aborted: File Not Found
```

For more information on the **LOAD** command, refer to chapter 3, section 7, *Program Utility Functions*.

Command Restriction: PCOP, ONLINE.

MB

The MegaBasic (**MB**) command is used to start the MegaBasic interpreter. After entering MegaBasic, you may develop, run, alter, and debug an application program.

To start MegaBasic, type **MB** on the command line and press the Enter key. This command places you at the MegaBasic command level, from which you can enter program lines and MegaBasic commands.

For more information on MegaBasic, refer to the *Series 90 Programmable Coprocessor Module and Support Software User's Manual*, GFK-0255.

Command Restriction: PCOP, ONLINE.

MDEL

The Module Delete (**MDEL**) command is used to delete user programs, data files, and configuration data from the PCM RAM Disk, or in the current folder. This command is only available in On-Line mode.

To use the **MDEL** command, type **mde** on the command line and press the Enter key.

The format of the **MDEL** command is:

MDEL pf

or

MDEL UCDF

pf	The name of the file on the PCM RAM Disk.
UCDF	The user configuration data on the PCM.

If the specified file cannot be located, the command is aborted and a "File Not Found" error is displayed.

MDEL UCDF deletes all configuration information associated with the user configuration. This will cause a hard reset before the modules are deleted, which the system will first ask you to confirm.

Note

The serial port setup for the PCM port will revert to the factory settings when UCDF is deleted.

For more information on the **MDEL** command, refer to chapter 3, section 7, *Program Utility Functions*.

Command Restriction: PCOP, ONLINE.

MDIR

The Module Directory (**MDIR**) command is used to list user programs, data files, and configuration data located on the PCM RAM Disk. This command is only available in On-Line mode.

To use the **MDIR** command, type **mdi** on the command line and press the Enter key.

For more information on the **MDIR** command, refer to chapter 3, section 7, *Program Utility Functions*.

Command Restriction: PCOP, ONLINE.

PORTS

The **PORTS** command is used to edit the serial port configuration for ports 1 and 2 on the Serial Port Data screen. Values are not required on this screen if the port is to be used by CCM. When the port has been selected for use by MegaBasic or the programmer, values may be entered for the port setup on this screen. If no user entries are made, the default settings are used.

To display the Serial Port Data screen, type **por** on the command line. When prompted, enter **1** or **2**, or use the Tab key to specify which port to modify.

The format of the **PORTS** command is:

```
POR [pn]
```

where **pn** is the port number.

For more information on the Serial Port Data screen, refer to chapter 4, section 3, *Standard Configuration Functions*.

Command Restriction: CONFIG.

READ

The Read Configuration Data (**READ**) command is used to read configuration data from a specified file.

The format of the **READ** command is:

```
READ fn
```

where **fn** is a file on the PC or on the PCM RAM Disk (RAM:fn). Press the Enter key again to begin the read operation.

For more information on the **READ** command, refer to chapter 4, section 4, *Advanced Configuration Functions*.

Command Restriction: CONFIG.

RUN

The **RUN** command is used to display the RUN User Task screen in On-Line mode. This screen is used to begin executing a task or group of tasks, specified by a module name. Selections are provided for the name of the task to run, the input/output/error devices, the stack and data size for the user task, background or foreground mode, task priority, and link modules.

To display the RUN User Task screen, type **run** on the command line and press the Enter key.

The format of the **RUN** command is:

```
RUN tn [options]
```

where **tn** is the task name to be run. Available options include:

Option	Description
>outchn1	Redirect standard output to channel 1.
<inchn1	Redirect standard input to channel 1.
?erchn1	Redirect standard error to channel 1.
/sXXXX	Use stack size of XXXX hex (200 default).
/dXXXX	Use data size of XXXX hex (also in code module).
/eX	Executable type, 1 (PRIORITY) by default.
/ix	Task ID.
/mName	Link to module "Name."
/b	Run the module in background mode.
/k	Keep the environment block after task terminates.

Valid arguments for the task to be run may also be entered.

Caution

The RUN command is not fully supported for this release. It is recommended that you perform a reset instead of using the RUN command.

For more information on the **RUN** command, refer to chapter 3, section 5, *Control Functions*.

Command Restriction: PCOP, ONLINE.

SAVE

The **SAVE** command is used to copy user programs, data, and configuration files from memory into a PC file. (MegaBasic has a similar **SAVE** command for saving MegaBasic source programs.)

To use the **SAVE** command, type **sav** on the command line and press the Enter key.

The format of the **SAVE** command is:

```
SAVE pf [fn]
```

where:

pf	The name of any file located on the PCM RAM Disk.
fn	The name of the file to be saved to.

For more information on the **SAVE** command, refer to chapter 3, section 7, *Program Utility Functions*.

Command Restriction: PCOP, ONLINE.

STASK

The System Task (**STASK**) command is used to display the Edit Programmer Communications and File Server Data screen. This screen allows you to edit programmer communications and file server data.

To display this screen, type **sta** on the command line and press the Enter key. Use the cursor or Enter keys to move to the field you want to edit, and then use the Tab key to select the desired standard device. If you change the values on this page, PCOP will prompt you to confirm these changes.

For more information on the **STASK** command, refer to chapter 4, section 4, *Advanced Configuration Functions*.

Command Restriction: CONFIG.

STATUS

Status functions are used to access status information about the PCM. Status information includes errors accumulated from the PCM while the PCOP package is attached, and also information about the currently active tasks and configuration.

To display the Status Functions menu, type `sta` on the command line and press the Enter key. Then, select the particular function you wish to perform.

For more information on status display functions, refer to chapter 3, section 4, *Status Functions*.

Command Restriction: PCOP.

STN

The STNDRD (`STN`) command is used to display the Edit Standard Configuration Data menu in the configuration editor. This menu contains the standard configuration functions.

To display this menu, type `stn` on the command line and press the Enter key.

For more information on the `STN` command, refer to chapter 4, section 3, *Standard Configuration Functions*.

Command Restriction: CONFIG.

STOP

The **STOP** command is used to display the STOP User Task screen in On-Line mode. This screen is used to stop a task from executing. To display this screen, type **stop** on the command line and press the Enter key.

The format of the **STOP** command is:

```
STOP tn
```

where **tn** is the task ID number to be stopped.

Enter the user task ID, or the numeral **8** if no user task number was specified for run.

After the command is executed, the message "Command Complete" is displayed on the message line.

Caution

The **STOP command is not fully supported for this release. It is recommended that you perform a reset instead of using the **STOP** command.**

For more information on the **STOP** command, refer to chapter 3, section 5, *Control Functions*.

Command Restriction: PCOP, ONLINE.

TERMF

The **TERMF** command is used to invoke the TERMF terminal emulation software package. This allows monitoring of a MegaBasic program which is currently executing. TERMF may also be invoked automatically if the PCM sends output on the serial port attached to PCOP. This happens, for example, when a soft reset starts MegaBasic.

To use the **TERMF** command, type **ter** on the command line and press the Enter key.

The ALT-Z key combination enables you to return to PCOP from TERMF. Pressing CTRL-BREAK exits directly to MS-DOS.

For more information on TERMF, refer to chapter 3, section 3, *TERMF*.

Command Restriction: PCOP.

USE

The **USE** command is used to activate a given configuration on the PCM in On-Line mode. This establishes the chosen data as the current active configuration.

The format of the **USE** command is:

USE UCDF

or

USE FCDF

or

USE fn

UCDF	The user configuration data file on the PCM.
FCDF	The factory default configuration.
fn	A user configuration file on the PC or on the PCM (RAM:).

Selecting **FCDF** on this screen is the same as initiating a hard reset, while selecting **UCDF** initiates a soft reset. This provides a remote reset function, as long as PCOP remains connected and on-line with the PCM.

If **fn** is specified after the **USE** command on the command line, the configuration data in the given file is loaded to the PCM. After loading, **USE fn** initiates a soft reset.

Note

If the configuration file being used will disconnect PCOP from the PCM or change serial port defaults, the **USE** command will time out rather than indicating completion. It is preferable, in this case, to use the **LOAD** command and then press the Restart/Reset pushbutton.

For more information on the **USE** command, refer to chapter 3, section 5, *Control Functions*.

Command Restriction: PCOP, ONLINE.

UTILTY

Program utility functions are used to manipulate files and memory modules on the PCM. The Program Utilities menu is only available in On-Line mode.

To display this menu, type `uti` on the command line and press the Enter key. Then, select the particular function you wish to perform.

For more information on program utility functions, refer to chapter 3, section 7, *Program Utility Functions*.

Command Restriction: PCOP, ONLINE.

VERSION

The `VERSION` command is used to view the PCM software version information. To display the current PCM software version information, type `ver` on the command line and press the Enter key.

Command Restriction: PCOP, ONLINE.

WRITE

The Write Configuration Data (`WRITE`) command is used to write configuration data from a specified file.

The format of the `WRITE` command is:

```
WRITE fn
```

where `fn` is a file on the PC or on the PCM RAM Disk (RAM:fn). Press the Enter key again to begin the write operation

For more information on the `WRITE` command, refer to chapter 4, section 4, *Advanced Configuration Functions*.

Command Restriction: CONFIG.

Appendix A

PCOP Menu Structure

The illustrations in this appendix show the PCOP menu structure and the available software function keys.

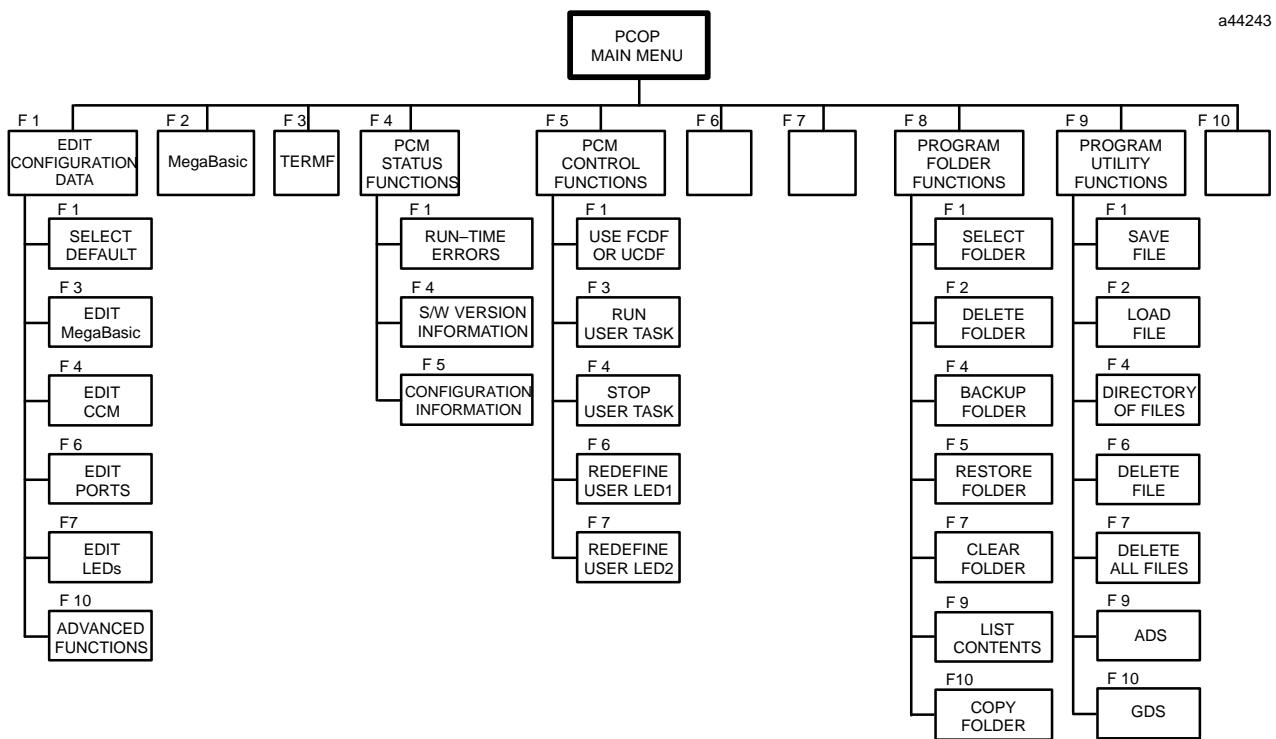

Figure A-1. PCOP Main Menu

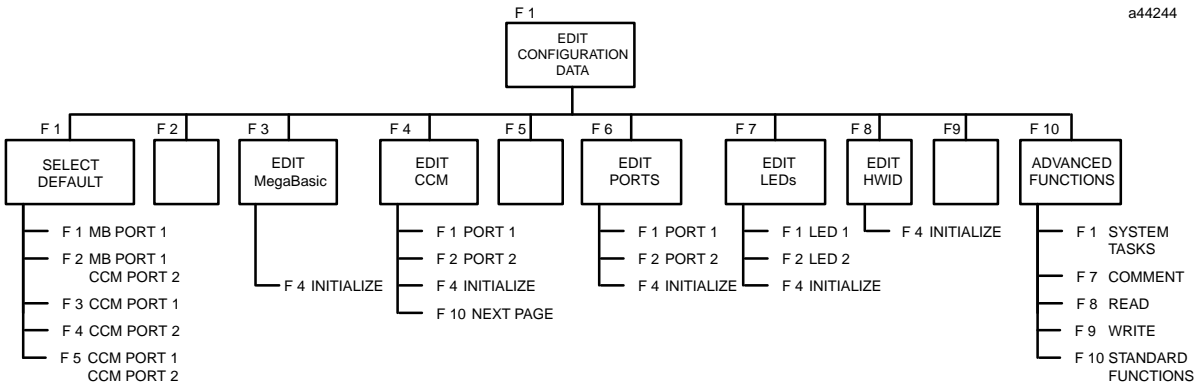

Figure A-2. Edit Configuration Data

Appendix B

Configuration Data

The configuration data consists of a group of records which contain assigned values for the various fields. This appendix lists the contents of these records, along with the range of values and default value for each field.

Table B-1. HWID Data

Field Name	Range of Values	Default Value
Total Ram Size (90-30 only)	32K, 160K, 192K	192K
Daughter Board Size (90-70 only)	None, 64K, 128K, 256K 512K	128K

Table B-2. MegaBasic Interpreter Data

Field Name	Range of Values	Default Value
EnableMegaBasic Task	Yes, No	YES
Start MB on Soft Reset	Yes, No	NO
Program to Run at Reset	If you want MegaBasic to start automatically upon a soft reset, enter the program file name.	No default value
User Program I/O: Input	COM1:, COM2:, RAM:fn, PC:fn, NULL:	COM1:
User Program I/O: Output	COM1:, COM2:, RAM:fn, PC:fn, NULL:	COM1:
User Program I/O: Error	COM1:, COM2:, RAM:fn, PC:fn, NULL:	COM1:
Task Priority	0 thru 8	6
MegaBasic CommandLine	Generally, the MegaBasic program file name.	No default value
AllocatedDataSize	Any valid integer 0 - 65,535	No default value

Table B-3. CCM Configuration Data

Field Name	Range of Values	Default Value
Enable CCM on Port	Yes, No	NO
CCM CPU ID	1 thru 254	1
Mode	Peer, Master, Slave	PEER
Turnaround Delay	None, 10 ms, 100 ms, 500 ms, Other	NONE
Timeout	Long, Medium, Short, None, Other	LONG
Retry Count	Normal, Short, Other	NORMAL
Data Rate	300, 600, 1200, 2400, 4800, 9600, 19200, 38400 bps	19200 bps
Parity	Odd, None	ODD
Flow Control	None, Hardware	NONE
Task Priority	0 thru 8 (0 disables). 1 thru 4 are usually reserved for system tasks.	5 or 6

Table B-4. CCM Detail Data

Field Name	Range of Values	Default Value
<i>Timeout Values</i>		
ACK/NAK after ENQ	Any valid integer 0 - 65,535	800 ms
Delay Retry of ENQ	Any valid integer 0 - 65,535	10 ms
ENQ Collision Backoff	Any valid integer 0 - 65,535	80 ms
Req Dead Time/ENQ	Any valid integer 0 - 65,535	20 ms
SOH after ENQ ACK	Any valid integer 0 - 65,535	800 ms
BCC after SOH	Any valid integer 0 - 65,535	670 ms
ACK after Hdr BCC	Any valid integer 0 - 65,535	2000 ms
STC after Hdr ACK	Any valid integer 0 - 65,535	20,000 ms
BCC after STX	Any valid integer 0 - 65,535	8340 ms
ACK after Data Blk BCC	Any valid integer 0 - 65,535	20,000 ms
EOT after last ACK	Any valid integer 0 - 65,535	800 ms
Delay Read ACK to Data Block	Any valid integer 0 - 65,535	10 ms
<i>Delay Values</i>		
Turnaround Delay	Any valid integer 0 - 65,535	0 ms
<i>Retry Counts</i>		
Header Block NAK	Any valid integer 0 - 65,535	3
Data Block NAK	Any valid integer 0 - 65,535	3
ENQ Sequence Timeout/NAK	Any valid integer 0 - 65,535	32

Table B-5. Serial Port Initialization Data

Field Name	Range of Values	Default Value
Interface	RS-232, RS-485	RS-232
Data Rate	300, 600, 1200, 2400, 4800, 9600, 19200, 38400 bps	19200 bps
Parity	Odd, Even, None	NONE
Flow Control	None, Hardware, Software	HARDWARE
Stop Bits	1 or 2	1
Bits per Character	7 or 8	8

Table B-6. LED Data

Field Name	Range of Values	Default Value
UserTaskControlled	0/1	0
Rx Backplane Activity	0/1	0
Tx Backplane Activity	0/1	0
Rx Serial Port 2	0/1	0
Rx Serial Port 1	0/1	1
Tx Serial Port 2	0/1	0
Tx Serial Port 1	0/1	1

Table B-7. Edit Annotation Data

Field Name	Range of Values	Default Value
PCMid	7-character name	No default value
Comment	0 thru 256 characters	No default value
EarliestPCMS/WRevision	Any, 2.0	2.0

Table B-8. Programmer and File Server Data

Field Name	Range of Values	Default Value
<i>Programmer Communications Data</i>		
Input	COM1:, COM2:, RAM:fn, PC:fn, NULL:	COM1:
Output	COM1:, COM2:, RAM:fn, PC:fn, NULL:	COM1:
Error	COM1:, COM2:, RAM:fn, PC:fn, NULL:	COM1:
Task Priority	1 thru 8	4
<i>File Server Data</i>		
Input	COM1:, COM2:	COM1:
Output	COM1:, COM2:	COM1:
Error	COM1:, COM2:	COM1:
Task Priority	1 thru 8	3

Appendix C

PCOP File Descriptions

The following files are placed on the hard disk during the PCOP INSTALL procedure. The **AUTOEXEC.BAT** and **CONFIG.SYS** files are optional; you can select not to install them.

File	Description
<u>\PCOP</u>	A directory.
ALM_RD.PGM	MegaBasic example reading %M bits.
ASMCHK.PGM	Refer to GFK-0256.
ASMDEFS.ASM	Refer to GFK-0256.
ASMPKG.BAT	Refer to GFK-0256.
BINARIES.DOC	Documents features of BYTESWAP.BIN and PORT_CTL.BIN
BITFUNCS.ASM	Source file with documentation for BITFUNCS.BIN
BITFUNCS.BIN	MegaBasic Utilities package for bit string operations.
BYTESWAP.BIN	MegaBasic utilities for checksum and reversing byte order of words.
CCM1.CDF	Default user configuration with CCM on port 1.
CCM12.CDF	Default user configuration with CCM on ports 1 and 2.
CCM1MB2.CDF	Default user configuration with CCM on port 1 and MegaBasic on port 2.
CCM2.CDF	Default user configuration with CCM on port 2.
CRUNCH.EXE	Compaction and encryption utility for MegaBasic program.
DEFAULT.DAT	TERM settings for factory mode on a Workmaster computer.
EXAMPLE.CDF	Simple configuration example that starts a MegaBasic program automatically in user mode.
EXAMPLES.DOC	Documentation of MegaBasic .PGM packages.
GENERIC.DOC	Line number referenced documentation of GENERIC.PGM and GEN_TEST.PGM
GENERIC.PGM	Definitions and procedures to access user references not directly supported by the PCM's backplane driver.
GEN_TEST.PGM	Sample program using GENERIC.PGM
GRAPH.PGM	Sample graph program.
LM90.DAT	
MB1.CDF	Default user configuration with MegaBasic on port 1.
MB1CCM2.CDF	Default user configuration with MegaBasic on port 1 and CCM on port 2.
MB2.CDF	Default user configuration with MegaBasic on port 2.
MBCRC.LST	Source file for MBCRC.PGM

File	Description
<u>\PCOP</u> (cont'd)	A directory.
MBCRC.PGM	MegaBasic CRC checksum package.
PCOP.EXE	PCM software (PCOP).
PORT_CTL.BIN	PCM serial port control and status utilities.
PRN_FLT.PGM	MegaBasic functions and procedures to analyze and print PLC and I/O fault records.
README.DOC	MegaBasic release notes.
README.TXT	Additional information file.
READ_FLT.PGM	MegaBasic functions and procedures to access PLC and I/O fault tables.
SAMPLE.PGM	Sample MegaBasic program.
TERM.DAT	TERM settings for factory mode on a Workmaster computer.
TERM.EXE	Terminal emulator without file transfer protocol.
TERMF.EXE	Terminal emulator with file transfer protocol.
TERMSET.EXE	Installation utility for setting TERM parameters.
TEST_FLT.PGM	How to use READ_FLT.PGM and PRN_FAULT.PGM to read and display fault information.
UTILITY.DOC	Documentation for using UTILITY.PGM
UTILITY.PGM	Procedures for gathering system information from the Series 90 CPU.
VT100.PGM	PCM MegaBasic extensions for VT100-style escape sequences. This file prints to STDOUT.
VT100_5.PGM	A companion file to VT100.PGM that prints to the device opening as #5.
<u>\PCOP\BAT</u>	A directory.
PCOP.BAT	Batch file to run PCOP from any directory.

Appendix D

CONFIG.SYS File

This appendix briefly describes how to edit a `CONFIG.SYS` file using the `EDLIN` line editor. For more complete information on using `EDLIN` commands and features, refer to your MS-DOS manual.

If you need to stop using `EDLIN` without saving the file, use the `QUIT` command (type `*Q` and press the Return key) to return to the command prompt.

Note

The following example entries assume that the file being edited is on drive C.

To edit the `CONFIG.SYS` file:

1. First, use the `DIR` command to display the contents of the root directory on your hard disk. If there is a `CONFIG.SYS` file on the disk, you can display its contents by typing `TYPE CONFIG.SYS` and pressing the Return key.
2. Enter the `EDLIN` command and the name of the file by typing `C>EDLIN CONFIG.SYS`. Then, press the Return key. `EDLIN` will prompt:

```
End of input file
*
```

The asterisk (*) is the `EDLIN` prompt.

3. The first step in editing the file is to display the file contents. Enter the `LIST` command by typing `*L` and pressing the Return key. The `CONFIG.SYS` file is listed as individual numbered lines. For example:

```
*L
1: break=on
2: buffers=5
3: files=20
4: device=ansi.sys
```

4. Compare the contents of your file with the entries required to run the PCM software. You can insert, delete, or edit lines, as described below. **EDLIN** commands can only be executed at the **EDLIN** asterisk prompt at the left side of the screen (not from a numbered line). To execute an **EDLIN** command, return to the asterisk prompt by pressing CTRL-C like this:

```
2: buffers=5
3: files=20
4: device=ansi.sys
5: *^C
```

A. Adding a Line:

- (1) To insert a line in the file, enter the **INSERT** command at the **EDLIN** asterisk prompt by typing ***I** and pressing the Return key.
- (2) The sequence of items in the **CONFIG.SYS** file is not important. However, if you want to insert the line in a particular order, you can specify a line number before entering the **INSERT** command. For example, to insert a line as line 5 in the file, type ***5I** and press the Return key. The line number will appear beside the asterisk prompt.
- (3) Now, type in the content for the line, and press the Return key at the end of the line.
- (4) Continue until all the necessary lines have been added to the file. After entering the last new line, press the Return key again. The next line number appears.
- (5) Press CTRL-C to return to the **EDLIN** asterisk prompt.

B. Removing a Line:

- (1) To delete a line from the file, enter the **DELETE** command at the asterisk prompt (at the left side of the screen).
- (2) Include the number of the line to delete.
- (3) Then, use the **LIST** command to verify the deletion.

C. Editing a Line:

- (1) To change part of an existing line, enter the line number at the asterisk prompt. In this next example, line 2 is selected for editing:

```
1: break=on
2: buffers=5
3: file=20
4: device=ansi.sys
5: *device=wmclock.sys
*2
```

- (2) The line appears again on the screen:

```
2: buffes=5
2: *
```

- (3) Enter the correct line and press the Return key.

```
2: buffers=5
2: *buffers=15
```

- (4) Press CTRL-C to return to the **EDLIN** asterisk prompt:

```
6: *^C
*
```

5. To finish using **EDLIN**, enter the **END** command by typing ***E** and pressing the Return key. The **END** command saves the new version of the file under the original file name (**CONFIG.SYS**). It also automatically creates a backup version of the file named **CONFIG.BAK**.
6. After you enter the **END** command and press the Return key, the MS-DOS command prompt appears. Type **TYPE CONFIG.SYS** and press the Return key to check the contents of the file.

After editing the **CONFIG.SYS** file, restart the computer. This must be done in order to use the entries in the new file. If the computer is not restarted, the previous version of the **CONFIG.SYS** file that was present the last time the computer was started up will continue to be used.

A

Accessing MegaBasic from PCOP, 3-8 ,
5-14

Accessing the PCOP main menu, 3-5

ADS (F9), 3-27 , 3-33

ADS command, 3-33 , 5-2

ADS software, 3-33 , 5-2

ADV command, 5-3

Advanced (F10), 4-4 , 4-7

Advanced configuration functions, 4-20 ,
5-3

- comment (F7), 4-20
- commentary data, 4-22 , 5-5
- programmer communications and file
server data, 4-20 , 5-17
- read configuration (F8), 4-20
- read configuration data, 4-23 , 5-15
- standard (F10), 4-20
- system task (F1), 4-20
- write configuration (F9), 4-20
- write configuration data, 4-24 , 5-21

ALM_RD.PGM, C-1

Alphanumeric display coprocessor mod-
ule, 3-33

ALT keys, 3-7

ASMCHK.PGM, C-1

ASMDEFS.ASM, C-1

ASMPKG.BAT, C-1

AUTOEXEC.BAT, 2-1 , 2-2 , 2-4 , 2-5

AUTOEXEC.L90, 2-1 , 2-4

B

Backing up the current program folder,
3-21 , 5-7

Backup folder (F4), 3-18 , 3-21

Basic (F3), 4-4 , 4-7 , 4-9

BASIC command, 5-3

BASIC.PGM, 4-11

BINARIES.DOC, C-1

BITFUNCS.ASM, C-1

BITFUNCS.BIN, C-1

BYTESWAPBIN, C-1

C

CCDF, 4-2

CCM (F4), 4-4 , 4-7

CCM command, 5-3

CCM configuration data, 4-12 , 5-3 , B-2

- definitions of entries on the edit CCM
configuration data screen
- CCM CPU ID, 4-14
- data rate, parity, flow control, 4-14
- enable CCM task on port, 4-14
- interface, 4-14
- mode, 4-14
- task priority, 4-14
- turnaround delay, timeout, retry count,
4-14

CCM detail data, 4-15 , B-2

CCM1.CDF, C-1

CCM12.CDF, C-1

CCM1MB2.CDF, C-1

CCM2.CDF, C-1

CFG command, 5-4

Changing PCM configuration mode, 3-13 ,
5-20

CHE command, 5-4

CIMPLICITY 90-ADS software, 3-33 , 5-2

CIMPLICITY 90-ADS system, 3-33 , 5-2

CIMPLICITY-70 graphics display system
software, 3-34 , 5-11

Clear (F7), 3-27 , 3-32

CLEAR command, 3-32 , 5-4

Clear folder (F7), 3-18 , 3-23

Clearing the current program folder, 3-23 ,
5-4 , 5-7

Comment (F7), 4-20

Commentary data, 4-22 , 5-5

- definitions of the entries on the edit an-
notation screen
- comment, 4-22
- earliest PCM software revision, 4-22
- PCM ID, 4-22

COMMNT command, 5-5

Communications, programmer, 4-20 , 5-17

A

Accessing MegaBasic from PCOP, 3-8 ,
5-14

Accessing the PCOP main menu, 3-5

ADS (F9), 3-27 , 3-33

ADS command, 3-33 , 5-2

ADS software, 3-33 , 5-2

ADV command, 5-3

Advanced (F10), 4-4 , 4-7

Advanced configuration functions, 4-20 ,
5-3

- comment (F7), 4-20
- commentary data, 4-22 , 5-5
- programmer communications and file
server data, 4-20 , 5-17
- read configuration (F8), 4-20
- read configuration data, 4-23 , 5-15
- standard (F10), 4-20
- system task (F1), 4-20
- write configuration (F9), 4-20
- write configuration data, 4-24 , 5-21

ALM_RD.PGM, C-1

Alphanumeric display coprocessor mod-
ule, 3-33

ALT keys, 3-7

ASMCHK.PGM, C-1

ASMDEFS.ASM, C-1

ASMPKG.BAT, C-1

AUTOEXEC.BAT, 2-1 , 2-2 , 2-4 , 2-5

AUTOEXEC.L90, 2-1 , 2-4

B

Backing up the current program folder,
3-21 , 5-7

Backup folder (F4), 3-18 , 3-21

Basic (F3), 4-4 , 4-7 , 4-9

BASIC command, 5-3

BASIC.PGM, 4-11

BINARIES.DOC, C-1

BITFUNCS.ASM, C-1

BITFUNCS.BIN, C-1

BYTESWAPBIN, C-1

C

CCDF, 4-2

CCM (F4), 4-4 , 4-7

CCM command, 5-3

CCM configuration data, 4-12 , 5-3 , B-2

- definitions of entries on the edit CCM
configuration data screen
- CCM CPU ID, 4-14
- data rate, parity, flow control, 4-14
- enable CCM task on port, 4-14
- interface, 4-14
- mode, 4-14
- task priority, 4-14
- turnaround delay, timeout, retry
count, 4-14

CCM detail data, 4-15 , B-2

CCM1.CDF, C-1

CCM12.CDF, C-1

CCM1MB2.CDF, C-1

CCM2.CDF, C-1

CFG command, 5-4

Changing PCM configuration mode, 3-13 ,
5-20

CHE command, 5-4

CIMPLICITY 90-ADS software, 3-33 , 5-2

CIMPLICITY 90-ADS system, 3-33 , 5-2

CIMPLICITY-70 graphics display system
software, 3-34 , 5-11

Clear (F7), 3-27 , 3-32

CLEAR command, 3-32 , 5-4

Clear folder (F7), 3-18 , 3-23

Clearing the current program folder, 3-23 ,
5-4 , 5-7

Comment (F7), 4-20

Commentary data, 4-22 , 5-5

- definitions of the entries on the edit an-
notation screen
- comment, 4-22
- earliest PCM software revision, 4-22
- PCM ID, 4-22

COMMNT command, 5-5

Communications, programmer, 4-20 , 5-17

- CONFIG command, 5-5
- CONFIG.L90, 2-1 , 2-4
- CONFIG.SYS, 2-1 , 2-2 , 2-4 , 2-5
 - local configuration file, 2-6
 - using EDLIN to edit a CONFIG.SYS file, D-1
 - using the CONFIG.SYS file to run other software, 2-2
- Configuration data, 4-2 , B-1
 - CCM configuration data, B-2
 - CCM detail data, B-2
 - edit annotation data, B-3
 - HWID data, B-1
 - LED data, B-3
 - MegaBasic interpreter data, B-1
 - programmer and file server data, B-4
 - serial port initialization data, B-3
- Configuration editor, 4-2
 - advanced configuration functions, 4-20 , 5-3
 - CCM configuration data, 4-12 , 5-3
 - CCM detail data, 4-15
 - commentary data, 4-22 , 5-5
 - configuration data, 4-2
 - configuration editor screen definitions, 4-5
 - configuring a PCM for MegaBasic programs, 4-11
 - current configuration data, 4-2
 - default configuration data, 4-7 , 5-6
 - edit configuration data menu, 4-3 , 5-5
 - Advanced (F10), 4-4
 - basic (F3), 4-4
 - CCM (F4), 4-4
 - defaults (F1), 4-4
 - hardware (F8), 4-4
 - LEDs (F7), 4-4
 - ports (F6), 4-4
 - expert mode, 5-1
 - factory default configuration data, 4-2
 - hardware configuration data, 4-8
 - help text, 4-6
 - MegaBasic interpreter data, 4-9 , 5-3
 - moving among the fields on an editor screen
 - backspace, 4-4
 - CTRL-BREAK, 4-4
 - cursor and enter, 4-4
 - delete, 4-4
 - end, 4-4
 - escape, 4-4
 - home, 4-4
 - programmer communications and file server data, 4-20 , 5-17
 - read configuration data, 4-23 , 5-15
 - redefining the user LEDs, 4-18
 - saving a configuration, 4-5
 - selecting field values, 4-6
 - serial port initialization data, 4-16 , 5-15
 - standard configuration functions, 4-7 , 5-18
 - user configuration data, 4-2
 - write configuration data, 4-24 , 5-21
- Configuration editor (F1), 3-7
- Configuration file, local, 2-6
 - TERMSET, 2-6
- Configuration functions, advanced, 4-20 , 5-3
 - comment (F7), 4-20
 - commentary data, 4-22 , 5-5
 - programmer communications and file server data, 4-20 , 5-17
 - read configuration (F8), 4-20
 - read configuration data, 4-23 , 5-15
 - standard (F10), 4-20
 - system task (F1), 4-20
 - write configuration (F9), 4-20
 - write configuration data, 4-24 , 5-21
- Configuration functions, standard, 4-7 , 5-18
 - Advanced (F10), 4-7
 - basic (F3), 4-7 , 4-9
 - CCM (F4), 4-7
 - CCM configuration data, 4-12 , 5-3
 - CCM detail data, 4-15
 - default configuration data, 4-7 , 5-6
 - defaults (F1), 4-7
 - hardware (F8), 4-7
 - hardware configuration data, 4-8
 - LEDs (F7), 4-7
 - MegaBasic interpreter data, 4-9 , 5-3
 - ports (6), 4-7
 - redefining the user LEDs, 4-18
 - serial port initialization data, 4-16 , 5-15
- Configuration mismatch, 2-8
- Configuring a PCM for MegaBasic programs, 4-11
- Configuring the PCM using PCOP, 4-1
 - advanced configuration functions, 4-20 , 5-3
 - CCM configuration data, 4-12 , 5-3
 - CCM detail data, 4-15
 - commentary data, 4-22 , 5-5
 - configuration data, 4-2

configuration editor, 4-2
 configuration editor screen definitions, 4-5
 configuring a PCM for MegaBasic programs, 4-11
 current configuration data, 4-2
 default configuration data, 4-7 , 5-6
 edit configuration data menu, 4-3 , 5-5
 factory default configuration data, 4-2
 hardware configuration data, 4-8
 help text, 4-6
 MegaBasic interpreter data, 4-9 , 5-3
 programmer communications and file server data, 4-20 , 5-17
 read configuration data, 4-23 , 5-15
 redefining the user LEDs, 4-18
 saving a configuration, 4-5
 selecting field values, 4-6
 serial port initialization data, 4-16 , 5-15
 standard configuration functions, 4-7 , 5-18
 user configuration data, 4-2
 write configuration data, 4-24 , 5-21
 Control functions, 3-12 , 5-5
 changing PCM configuration mode, 3-13 , 5-20
 executing a task, 3-14 , 5-16
 LED 1 (F6), 3-12 , 3-16
 LED 2 (F7), 3-12 , 3-16
 redefining the user LEDs, 3-16
 run (F3), 3-12 , 3-14
 stop (F4), 3-12 , 3-15
 stopping a task, 3-15 , 5-19
 use (F1), 3-12 , 3-13
 Control functions (F5), 3-7 , 3-12 , 5-5
 Copy folder (F10), 3-18 , 3-25
 Copying a program folder, 3-25 , 5-8
 Creating a program folder, 3-4 , 3-19 , 5-10
 CRUNCHEXE, C-1
 CTL command, 5-5
 CTRL-BREAK, 3-5 , 3-7
 Current configuration data, 4-2

D

Daughter board size, 4-8
 Default configuration data, 4-7 , 5-6
 DEFAULT.DAT, 2-8 , C-1

Defaults (F1), 4-4 , 4-7
 DEFLTS command, 5-6
 Delete file (F6), 3-27 , 3-31
 Delete folder (F2), 3-18 , 3-20
 Deleting a file, 3-31 , 5-14
 Deleting a program folder, 3-20 , 5-8
 Deleting all files on the PCM, 3-32
 Directory of files, 3-30 , 5-15

E

Edit annotation data, B-3
 Edit configuration data menu, 4-3 , 5-5
 Advanced (F10), 4-4
 basic (F3), 4-4
 CCM (F4), 4-4
 Defaults (F1), 4-4
 hardware (F8), 4-4
 LEDs (F7), 4-4
 ports (F6), 4-4
 EDLIN, 2-4
 using EDLIN to edit a CONFIG.SYS file, D-1
 adding a line, D-2
 editing a line, D-2
 removing a line, D-2
 Error display screen, 3-11
 execution errors, 3-11
 user command syntax errors, 3-11
 ERRORS command, 5-6
 Escape key, 3-5 , 3-7
 EXAMPLE.CDF, C-1
 EXAMPLES.DOC, C-1
 Executing a task, 3-14 , 5-16
 Execution errors, 3-11
 EXIT command, 5-6
 Exiting TERMF, 2-8
 Expert mode, 3-6
 ADS, 5-2
 ADV, 5-3
 BASIC, 5-3
 CCM, 5-3
 CFG, 5-4
 CHE, 5-4
 CLEAR, 5-4
 COMMNT, 5-5

CONFIG, 5-5
CTL, 5-5
DEFLTS, 5-6
ERRORS, 5-6
EXIT, 5-6
FBAKUP, 5-7
FCLEAR, 5-7
FCOPY, 5-8
FDEL, 5-8
FDIR, 5-9
FLOCK, 5-9
FOLDER, 5-9
FRESTR, 5-10
FSEL, 5-10
GDS, 5-11
HELP, 5-11
LED, 5-12
LOAD, 5-13
MB, 5-14
MDEL, 5-14
MDIR, 5-15
PORTS, 5-15
READ, 5-15
RUN, 5-16
SAVE, 5-17
STASK, 5-17
STATUS, 5-18
STN, 5-18
STOP, 5-19
TERM, 5-19
USE, 5-20
using ALT-J to toggle between expert
and non-expert mode, 5-1
using commands for expert mode, 5-1
using PCOP in expert mode, 5-1
UTILITY, 5-21
VERSION, 5-21
WRITE, 5-21

F

Factory default configuration, 3-2
Factory default configuration data, 4-2
FBAKUP command, 5-7
FCDF, 4-2
FCLEAR command, 5-7
FCOPY command, 5-8
FDEL command, 5-8
FDIR command, 5-9

File descriptions, PCOP, C-1
ALM_RD.PGM, C-1
ASMCHK.PGM, C-1
ASMDEFS.ASM, C-1
ASMPKG.BAT, C-1
BINARIES.DOC, C-1
BITFUNCS.ASM, C-1
BITFUNCS.BIN, C-1
BYTESWAPBIN, C-1
CCM1.CDF, C-1
CCM12.CDF, C-1
CCM1MB2.CDF, C-1
CCM2.CDF, C-1
CRUNCH.EXE, C-1
DEFAULT.DAT, C-1
EXAMPLE.CDF, C-1
EXAMPLES.DOC, C-1
GEN_TEST.PGM, C-1
GENERIC.DOC, C-1
GENERIC.PGM, C-1
GRAPH.PGM, C-1
LM90.DAT, C-1
MB1.CDF, C-1
MB1CCM2.CDF, C-1
MB2.CDF, C-1
MBCRC.LST, C-1
MBCRC.PGM, C-2
PCOP.BAT, C-2
PCOPEXE, C-2
PORT_CTL.BIN, C-2
PRN_FLTPGM, C-2
READ_FLTPGM, C-2
README.DOC, C-2
README.TXT, C-2
SAMPLE.PGM, C-2
TERM.DAT, C-2
TERM.EXE, C-2
TERMFEXE, C-2
TERMSETEXE, C-2
TEST_FLTPGM, C-2
UTILITY.DOC, C-2
UTILITY.PGM, C-2
VT100.PGM, C-2
VT100_5.PGM, C-2
File directory (F4), 3-27 , 3-30
File server data, 4-20 , 5-17
FLOCK command, 5-9
FOLDER command, 5-9
Folder directory (F9), 3-18 , 3-24
Folder functions (F8), 3-7 , 3-18 , 5-9
Folder, program, initially selecting/creat-
ing a program folder, 3-4

FRESTR command, 5-10
FSEL command, 5-10
Function softkeys, 3-5

G

GDS (F10), 3-27 , 3-34
GDS command, 3-34 , 5-11
GDS software, 3-34 , 5-11
GEN_TESTPGM, C-1
GENERIC.DOC, C-1
GENERIC.PGM, C-1
GRAPH.PGM, C-1

H

Hard reset, 3-2 , 3-6
 initiating a hard reset by selecting “factory”, 3-13
Hardware (F8), 4-4 , 4-7
Hardware configuration data, 4-8
 daughter board size, 4-8
 total memory size, 4-8
Hardware ID data, B-1
HELP command, 5-11
Help text, 4-6
 cursor movement keys, 4-6
 data editing keys, 4-6

I

Installing the PCM development software (PCOP), 2-1
 AUTOEXEC.BAT and CONFIG.SYS, 2-1 , D-1
 connecting the PCM to the programmer, 2-7
 DEFAULT.DAT, 2-8
 descriptions of files placed on the hard disk during INSTALL, C-1
 diagnosing serial communication problems, 2-8
 INSTALL procedure, 2-2
 local configuration file, 2-6
 PCOP DEFAULT.DAT, 2-8

 placing the PCM in program mode, 2-7
 TERMF DEFAULT.DAT, 2-8
 using the CONFIG.SYS file to run other software, 2-2
 using the EDLIN utility to modify your CONFIG.SYS file, 2-4

Installing the PCOP development software (PCOP), software version number, 2-7

Invoking TERME, 3-9

K

Key commands, 3-7
 ALT keys, 3-7
 CTRL-BREAK, 3-7
 Escape key, 3-7

Key summary, 3-7
 configuration editor (F1), 3-7
 control functions (F5), 3-7 , 3-12 , 5-5
 folder functions (F8), 3-7 , 3-18 , 5-9
 MegaBasic interpreter (F2), 3-7 , 3-8
 status functions (F4), 3-7 , 3-10 , 5-18
 TERMF (F3), 3-7 , 3-9 , 5-19
 utility functions (F9), 3-7 , 3-26 , 5-21

L

LED 1 (F6), 3-12 , 3-16
LED 2 (F7), 3-12 , 3-16
LED command, 5-12
LED data, B-3
LED indicators
 USER1, 2-8
 USER2, 2-8
LED USE command, 3-16
LEDs (F7), 4-4 , 4-7
Listing the contents of the current program folder, 3-24 , 5-9
LM90.DAT, C-1
LOAD command, 3-29 , 5-13
Load file (F2), 3-27 , 3-29
LOADMY.PGM, 5-2
Loading a file to the PCM, 3-29 , 5-13
Locking the current program folder, 5-9

M

Main menu for PCOP, 3-2
 accessing the main menu, 3-5

- backing up the current program folder, 3-21 , 5-7
 - changing PCM configuration mode, 3-13 , 5-20
 - clearing the current program folder, 3-23 , 5-4 , 5-7
 - copying a program folder, 3-25 , 5-8
 - creating/selecting a program folder, 3-19 , 5-10
 - current configuration field, 3-6
 - deleting a file, 3-31 , 5-14
 - deleting a program folder, 3-20 , 5-8
 - deleting all files on the PCM, 3-32
 - directory of files, 3-30 , 5-15
 - error display screen, 3-11
 - executing a task, 3-14 , 5-16
 - key summary, 3-7
 - configuration editor (F1), 3-7
 - control functions (F5), 3-7 , 3-12 , 5-5
 - folder functions (F8), 3-7 , 3-18 , 5-9
 - MegaBasic interpreter (F2), 3-7 , 3-8
 - status functions (F4), 3-7 , 3-10 , 5-18
 - TERMF (F3), 3-7 , 3-9 , 5-19
 - utility functions (F9), 3-7 , 3-26 , 5-21
 - listing the contents of the current program folder, 3-24 , 5-9
 - loading a file to the PCM, 3-29 , 5-13
 - locking/unlocking the current program folder, 5-9
 - message line, 3-6
 - ONLINE status, 3-5
 - PCM ID, 3-6
 - redefining the user LEDs, 3-16
 - restoring the current program folder, 3-22 , 5-10
 - returning to PCOP, 3-9
 - runtime errors, 3-5
 - saving a file from the PCM, 3-28 , 5-17
 - stopping a task, 3-15 , 5-19
 - using ADS software, 3-33 , 5-2
 - using GDS software, 3-34 , 5-11
- MB command, 5-14
- MB1.CDF, C-1
- MB1CCM2.CDF, C-1
- MB2.CDF, C-1
- MBCRC.LST, C-1
- MBCRC.PGM, C-2
- MDEL command, 3-31 , 5-14
- MDIR command, 3-30 , 5-15
- MegaBasic, 3-8
 - accessing MegaBasic from PCOP, 3-8 , 5-14
 - returning to PCOP, 3-8
- MegaBasic interpreter (F2), 3-7 , 3-8
- MegaBasic interpreter data, 4-9 , 5-3 , B-1
- definitions of entries on the MegaBasic interpreter task screen
 - allocated data size, 4-10
 - enable MegaBasic task, 4-10
 - MegaBasic command line, 4-10
 - program to run at reset, 4-10
 - start MB task on soft reset, 4-10
 - task priority, 4-10
 - user program I/O, 4-10
- Memory size, total, 4-8
- Message line, 3-6
- ## N
- NO COMM status, 3-3
- ## O
- ONLINE status, 3-3
- ## P
- PC:UCDFCDE, 4-5
- PCOP, 3-1 , C-1 , C-2
 - accessing MegaBasic from PCOP, 3-8 , 5-14
 - accessing the PCOP main menu, 3-5
 - ALT keys, 3-7
 - backing up the current program folder, 3-21 , 5-7
 - changing PCM configuration mode, 3-13 , 5-20
 - clearing the current program folder, 3-23 , 5-4 , 5-7
 - control functions, 3-12 , 5-5
 - LED 1 (F6), 3-12 , 3-16
 - LED 2 (F7), 3-12 , 3-16
 - run (F3), 3-12 , 3-14
 - stop (F4), 3-12 , 3-15
 - use (F1), 3-12 , 3-13
 - copying a program folder, 3-25 , 5-8
 - creating/selecting a program folder, 3-19 , 5-10
- CTRL-BREAK, 3-7

- deleting a file, 3-31 , 5-14
- deleting a program folder, 3-20 , 5-8
- deleting all files on the PCM, 3-32
- descriptions of files placed on the hard disk during INSTALL, C-1
 - ALM_RD.PGM, C-1
 - ASMCHK.PGM, C-1
 - ASMDEFS.ASM, C-1
 - ASMPKG.BAT, C-1
 - BINARIES.DOC, C-1
 - BITFUNCS.ASM, C-1
 - BITFUNCS.BIN, C-1
 - BYTESWAPBIN, C-1
 - CCM1.CDF, C-1
 - CCM12.CDF, C-1
 - CCM1MB2.CDF, C-1
 - CCM2.CDF, C-1
 - CRUNCH.EXE, C-1
 - DEFAULTDAT, C-1
 - EXAMPLE.CDF, C-1
 - EXAMPLES.DOC, C-1
 - GEN_TESTPGM, C-1
 - GENERIC.DOC, C-1
 - GENERIC.PGM, C-1
 - GRAPH.PGM, C-1
 - LM90.DAT, C-1
 - MB1.CDF, C-1
 - MB1CCM2.CDF, C-1
 - MB2.CDF, C-1
 - MBCRC.LST, C-1
 - MBCRC.PGM, C-2
 - PCOP.BAT, C-2
 - PCOPEXE, C-2
 - PORT_CTL.BIN, C-2
 - PRN_FLT.PGM, C-2
 - READ_FLT.PGM, C-2
 - README.DOC, C-2
 - README.TXT, C-2
 - SAMPLE.PGM, C-2
 - TERM.DAT, C-2
 - TERM.EXE, C-2
 - TERMFEXE, C-2
 - TERMSETEXE, C-2
 - TEST_FLT.PGM, C-2
 - UTILITY.DOC, C-2
 - UTILITY.PGM, C-2
 - VT100.PGM, C-2
 - VT100_5.PGM, C-2
- directory of files, 3-30 , 5-15
- edit configuration data menu structure, A-1
- error display screen, 3-11
- Escape key, 3-7
- executing a task, 3-14 , 5-16
- expert mode, 3-6
 - ADS, 5-2
 - ADV, 5-3
 - BASIC, 5-3
 - CCM, 5-3
 - CFG, 5-4
 - CHE, 5-4
 - CLEAR, 5-4
 - COMMNT, 5-5
 - CONFIG, 5-5
 - CTL, 5-5
 - DEFLT5, 5-6
 - ERRORS, 5-6
 - EXIT, 5-6
 - FBAKUP, 5-7
 - FCLEAR, 5-7
 - FCOPY, 5-8
 - FDEL, 5-8
 - FDIR, 5-9
 - FLOCK, 5-9
 - FOLDER, 5-9
 - FRESTR, 5-10
 - FSEL, 5-10
 - GDS, 5-11
 - HELP, 5-11
 - LED, 5-12
 - LOAD, 5-13
 - MB, 5-14
 - MDEL, 5-14
 - MDIR, 5-15
 - PORTS, 5-15
 - READ, 5-15
 - RUN, 5-16
 - SAVE, 5-17
 - STASK, 5-17
 - STATUS, 5-18
 - STN, 5-18
 - STOP, 5-19
 - TERM, 5-19
 - USE, 5-20
 - UTILITY, 5-21
 - VERSION, 5-21
 - WRITE, 5-21
- function softkeys, 3-5
- initially selecting/creating a program folder, 3-4
- invoking PCOP, 3-2
- invoking TERM, 3-9
- key summary, 3-7
- listing the contents of the current program folder, 3-24 , 5-9
- loading a file to the PCM, 3-29 , 5-13
- locking/unlocking the current program folder, 5-9
- main menu, 3-2 , A-1

- menu structure, A-1
 - NO COMM status, 3-3
 - ONLINE status, 3-3
 - program folder functions, 3-18 , 5-9
 - backup folder (F4), 3-18 , 3-21
 - clear folder (F7), 3-18 , 3-23
 - copy folder (F10), 3-18 , 3-25
 - delete folder (F2), 3-18 , 3-20
 - folder directory (F9), 3-18 , 3-24
 - restore folder (F5), 3-18 , 3-22
 - select folder (F1), 3-18 , 3-19
 - program utility functions
 - ADS (F9), 3-27 , 3-33
 - clear (F7), 3-27 , 3-32
 - delete file (F6), 3-27 , 3-31
 - file directory (F4), 3-27 , 3-30
 - GDS (F10), 3-27 , 3-34
 - load file (F2), 3-27 , 3-29
 - save file (F1), 3-27 , 3-28
 - redefining the user LEDs, 3-16
 - restoring the current program folder, 3-22 , 5-10
 - returning to PCOP, 3-8 , 3-9
 - runtime errors, 3-5
 - saving a file from the PCM, 3-28 , 5-17
 - special key commands, 3-7
 - status display functions, 5-18
 - status functions, 3-10
 - stopping a task, 3-15 , 5-19
 - TERME, 3-9 , 5-19
 - types of errors processed by PCOP, 3-11
 - using ADS software, 3-33 , 5-2
 - using GDS software, 3-34 , 5-11
 - using PCOP in expert mode, 5-1
 - utility functions, 3-26 , 5-21
- PCOP DEFAULT.DAT, 2-8
- PCOPBAT, C-2
- PCOPEXE, C-2
- PORT_CTL.BIN, C-2
- Ports (F6), 4-4 , 4-7
- PORTS command, 5-15
- PRN_FLTPGM, C-2
- Program folder, initially selecting/creating a program folder, 3-4
- Program folder functions, 3-18 , 5-9
 - backing up the current program folder, 3-21 , 5-7
 - backup folder (F4), 3-18 , 3-21
 - clear folder (F7), 3-18 , 3-23
 - clearing the current program folder, 3-23 , 5-4 , 5-7
 - copy folder (F10), 3-18 , 3-25
 - copying a program folder, 3-25 , 5-8
 - creating/selecting a program folder, 3-19 , 5-10
 - delete folder (F2), 3-18 , 3-20
 - deleting a program folder, 3-20 , 5-8
 - folder directory (F9), 3-18 , 3-24
 - listing the contents of the current program folder, 3-24 , 5-9
 - locking/unlocking the current program folder, 5-9
 - restore folder (F5), 3-18 , 3-22
 - restoring the current program folder, 3-22 , 5-10
 - select folder (F1), 3-18 , 3-19
- Program folder functions (F8), 3-18 , 5-9
- Program folders, 3-18 , 5-9
 - backing up the current program folder, 3-21 , 5-7
 - clearing the current program folder, 3-23 , 5-4 , 5-7
 - copying a program folder, 3-25 , 5-8
 - creating/selecting a folder, 3-19 , 5-10
 - deleting a program folder, 3-20 , 5-8
 - listing the contents of the current program folder, 3-24 , 5-9
 - locking/unlocking the current program folder, 5-9
 - restoring the current program folder, 3-22 , 5-10
- Program mode, 2-7
- Program utility functions
 - ADS (F9), 3-27 , 3-33
 - clear (F7), 3-27 , 3-32
 - delete file (F6), 3-27 , 3-31
 - deleting a file, 3-31 , 5-14
 - deleting all files on the PCM, 3-32
 - directory of files, 3-30 , 5-15
 - file directory (F4), 3-27 , 3-30
 - GDS (F10), 3-27 , 3-34
 - load file (F2), 3-27 , 3-29
 - loading a file to the PCM, 3-29 , 5-13
 - save file (F1), 3-27 , 3-28
 - saving a file from the PCM, 3-28 , 5-17
 - using ADS software, 3-33 , 5-2
 - using GDS software, 3-34 , 5-11
- Programmer and file server data, B-4
- Programmer communications, 4-20 , 5-17
- Programming the PCM using PCOP, 3-1
 - accessing MegaBasic from PCOP, 3-8 , 5-14

accessing the PCOP main menu, 3-5
 ALT keys, 3-7
 backing up the current program folder,
 3-21 , 5-7
 changing PCM configuration mode,
 3-13 , 5-20
 clearing the current program folder,
 3-23 , 5-4 , 5-7
 control functions, 3-12 , 5-5
 copying a program folder, 3-25 , 5-8
 creating/selecting a program folder, 3-19
 , 5-10
 CTRL-BREAK, 3-7
 deleting a file, 3-31 , 5-14
 deleting a program folder, 3-20 , 5-8
 deleting all files on the PCM, 3-32
 directory of files, 3-30 , 5-15
 error display screen, 3-11
 Escape key, 3-7
 executing a task, 3-14 , 5-16
 expert mode, 3-6
 function softkeys, 3-5
 initially selecting/creating a program
 folder, 3-4
 invoking PCOP, 3-2
 invoking TERME, 3-9
 key summary, 3-7
 listing the contents of the current pro-
 gram folder, 3-24 , 5-9
 loading a file to the PCM, 3-29 , 5-13
 locking/unlocking the current program
 folder, 5-9
 NO COMM status, 3-3
 ONLINE status, 3-3
 PCOP main menu, 3-2
 program folder functions, 3-18 , 5-9
 redefining the user LEDs, 3-16
 restoring the current program folder,
 3-22 , 5-10
 returning to PCOP, 3-8 , 3-9
 runtime errors, 3-5
 saving a file from the PCM, 3-28 , 5-17
 special key commands, 3-7
 status display functions, 5-18
 status functions, 3-10
 stopping a task, 3-15 , 5-19
 TERME, 3-9 , 5-19
 using ADS software, 3-33 , 5-2
 using GDS software, 3-34 , 5-11
 utility functions, 3-26 , 5-21

R

READ command, 5-15
 Read configuration (F8), 4-20
 Read configuration data, 4-23 , 5-15
 READ_FLTPGM, C-2
 README.DOC, C-2
 README.TXT, C-2
 Redefining the user LEDs, 3-16 , 4-18
 Restore folder (F5), 3-18 , 3-22
 Restoring the current program folder, 3-22
 , 5-10
 Returning to PCOP, 3-8 , 3-9
 Run (F3), 3-12 , 3-14
 RUN command, 3-14 , 5-16
 Runtime errors, 3-5

S

SAMPLE.PGM, C-2
 SAVE command, 3-28 , 5-17
 Save file (F1), 3-27 , 3-28
 Saving a configuration, 4-5
 Saving a file from the PCM, 3-28 , 5-17
 Select folder (F1), 3-18 , 3-19
 Selecting a program folder, 3-4 , 3-19 , 5-10

 Selecting configuration field values, 4-6
 Serial communication problems, 2-8
 Serial port initialization data, 4-16 , 5-15 ,
 B-3
 definitions of entries on the serial port
 data screen
 bits per character, 4-17
 data rate, 4-17
 flow control, 4-17
 interface, 4-17
 parity, 4-17
 stop bits, 4-17
 Soft reset, 3-2 , 3-6
 initiating a soft reset by selecting “user”,
 3-13
 Software version number, 2-7
 Standard (F10), 4-20

Standard configuration functions, 4-7 ,
5-18
 Advanced (F10), 4-7
 basic (F3), 4-7 , 4-9
 CCM (F4), 4-7
 CCM configuration data, 4-12 , 5-3
 CCM detail data, 4-15
 configuring a PCM for MegaBasic pro-
 grams, 4-11
 default configuration data, 4-7 , 5-6
 defaults (F1), 4-7
 hardware (F8), 4-7
 hardware configuration data, 4-8
 LEDs (F7), 4-7
 MegaBasic interpreter data, 4-9 , 5-3
 ports (F6), 4-7
 redefining the user LEDs, 4-18
 serial port initialization data, 4-16 , 5-15

STASK command, 5-17

STATUS command, 5-18

Status display functions, 5-18

Status functions, 3-10
 error display screen, 3-11

Status functions (F4), 3-7 , 3-10 , 5-18

STN command, 5-18

Stop (F4), 3-12 , 3-15

STOP command, 3-15 , 5-19

Stopping a task, 3-15 , 5-19

System task (F1), 4-20

T

TERM.DAT, 2-6 , 3-9 , C-2

TERM.EGA, 2-6

TERM.EXE, 3-9 , C-2

TERM.MON, 2-6

TERMF 3-9 , 5-19
 exiting TERMF, 2-8
 invoking TERMF, 3-9

TERMF (F3), 3-7 , 3-9 , 5-19

TERMF command, 5-19

TERMF DEFAULT.DAT, 2-8

TERMF.EXE, C-2

TERMSET, 2-6
 TERM.EGA, 2-6
 TERM.MON, 2-6

TERMSET.EXE, 3-9 , C-2

TEST_FLTPGM, C-2

Total memory size, 4-8

Troubleshooting, 2-8
 configuration mismatch, 2-8
 diagnosing serial communication prob-
 lems, 2-8

TYPE command, 2-2

U

UCDE, 4-2

UCDECDF, 4-23 , 4-24

Unlocking the current program folder, 5-9

Use (F1), 3-12 , 3-13

USE command, 3-13 , 5-20

User command syntax errors, 3-11

User configuration data, 4-2

USER1 LED, 2-8

USER2 LED, 2-8

Utility functions, 3-26 , 5-21

Utility functions (F9), 3-7 , 3-26 , 5-21

UTILITY.DOC, C-2

UTILITY.PGM, C-2

UTILTY command, 5-21

V

VERSION command, 5-21

VT100.PGM, C-2

VT100_5.PGM, C-2

W

WRITE command, 5-21

Write configuration (F9), 4-20

Write configuration data, 4-24 , 5-21