

GE  
Intelligent Platforms

Programmable Control Products

PACSystems\*  
RX3i Genius\*  
Communications  
Gateway  
User Manual

GFK-2892A  
March 2015



## Warnings, Cautions, and Notes as Used in this Publication

---



### Warning

Warning notices are used in this publication to emphasize that hazardous voltages, currents, temperatures, or other conditions that could cause personal injury exist in this equipment or may be associated with its use.

In situations where inattention could cause either personal injury or damage to equipment, a Warning notice is used.

---



### Caution

Caution notices are used where equipment might be damaged if care is not taken.

---

**Note:** Notes merely call attention to information that is especially significant to understanding and operating the equipment.

These instructions do not purport to cover all details or variations in equipment, nor to provide for every possible contingency to be met during installation, operation, and maintenance. The information is supplied for informational purposes only, and GE makes no warranty as to the accuracy of the information included herein. Changes, modifications, and/or improvements to equipment and specifications are made periodically and these changes may or may not be reflected herein. It is understood that GE may make changes, modifications, or improvements to the equipment referenced herein or to the document itself at any time. This document is intended for trained personnel familiar with the GE products referenced herein.

GE may have patents or pending patent applications covering subject matter in this document. The furnishing of this document does not provide any license whatsoever to any of these patents.

GE PROVIDES THE FOLLOWING DOCUMENT AND THE INFORMATION INCLUDED THEREIN AS-IS AND WITHOUT WARRANTY OF ANY KIND, EXPRESSED OR IMPLIED, INCLUDING BUT NOT LIMITED TO ANY IMPLIED STATUTORY WARRANTY OF MERCHANTABILITY OR FITNESS FOR PARTICULAR PURPOSE.

\* indicates a trademark of General Electric Company and/or its subsidiaries. All other trademarks are the property of their respective owners.

# Contact Information

---

If you purchased this product through an Authorized Channel Partner, please contact the seller directly.

## **General Contact Information**

Online technical support and GlobalCare	<a href="http://support.ge-ip.com">http://support.ge-ip.com</a>
Additional information	<a href="http://www.ge-ip.com/">http://www.ge-ip.com/</a>
Solution Provider	<a href="mailto:solutionprovider.ip@ge.com">solutionprovider.ip@ge.com</a>

## **Technical Support**

If you have technical problems that cannot be resolved with the information in this manual, please contact us by telephone or email, or on the web at <http://support.ge-ip.com>

## **Americas**

Online Technical Support	<a href="http://support.ge-ip.com">http://support.ge-ip.com</a>
Phone	1-800-433-2682
International Americas Direct Dial	1-780-420-2010 (if toll free 800 option is unavailable)
Technical Support Email	<a href="mailto:support.ip@ge.com">support.ip@ge.com</a>
Customer Care Email	<a href="mailto:customercare.ip@ge.com">customercare.ip@ge.com</a>
Primary language of support	English

## **Europe, the Middle East, and Africa**

Online Technical Support	<a href="http://support.ge-ip.com">http://support.ge-ip.com</a>
Phone	+ 800-1-433-2682
EMEA Direct Dial	+ 420-23-901-5850 (if toll free 800 option is unavailable or dialing from a mobile telephone)
Technical Support Email	<a href="mailto:support.emea.ip@ge.com">support.emea.ip@ge.com</a>
Customer Care Email	<a href="mailto:customercare.emea.ip@ge.com">customercare.emea.ip@ge.com</a>
Primary languages of support	English, French, German, Italian, Czech, Spanish

## **Asia Pacific**

Online Technical Support	<a href="http://support.ge-ip.com">http://support.ge-ip.com</a>
Phone	+ 86-400-820-8208
	+ 86-21-3217-4826 (India, Indonesia, and Pakistan)
Technical Support Email	<a href="mailto:support.cn.ip@ge.com">support.cn.ip@ge.com</a> (China)
	<a href="mailto:support.jp.ip@ge.com">support.jp.ip@ge.com</a> (Japan)
	<a href="mailto:support.in.ip@ge.com">support.in.ip@ge.com</a> (remaining Asia customers)
Customer Care Email	<a href="mailto:customercare.apo.ip@ge.com">customercare.apo.ip@ge.com</a>
	<a href="mailto:customercare.cn.ip@ge.com">customercare.cn.ip@ge.com</a> (China)

## Contents

<b>CHAPTER 1</b>	<b>INTRODUCTION</b>	<b>1</b>
1.1	MANUAL REVISIONS	1
1.2	DESCRIPTION	2
1.3	PRODUCT OVERVIEW	3
1.4	SPECIFICATIONS	4
1.5	CONTROLS AND INDICATORS	5
1.5.1	<i>Mounting</i>	6
1.6	PROFINET OPERATION OVERVIEW	7
1.7	SYSTEM LIMITS	10
1.8	OPERATIONAL DIFFERENCES VS. GENIUS BUS CONTROLLER	11
1.9	SUPPORTED GENIUS DEVICES	12
1.10	GLOSSARY	13
1.11	REFERENCES	13
<b>CHAPTER 2</b>	<b>INSTALLATION</b>	<b>15</b>
2.1	PRE-INSTALLATION CHECK	15
2.2	INSTALLATION LOCATION	15
2.3	INSTALLATION IN HAZARDOUS AREAS	16
2.3.1	<i>ATEX Zone 2</i>	16
2.3.2	<i>ATEX Marking</i>	16
2.4	MODULE INSTALLATION	17
2.4.1	<i>Install SD Card</i>	17
2.4.2	<i>Mounting the GCG001</i>	17
2.4.3	<i>GCG001 Module Removal</i>	19
2.4.4	<i>Light-Emitting Diode (LED) Indications</i>	20
2.4.5	<i>Fault Notifications</i>	21
2.5	CONFIGURING THE GENIUS GATEWAY TO OPERATE WITH THE RX3I CPU	21
2.6	ETHERNET PORT CONNECTIONS	21
2.6.1	<i>RJ-45 Port Connections</i>	22
2.7	FIRMWARE UPDATES	22
2.8	SPARE PARTS	23
<b>CHAPTER 3</b>	<b>CONFIGURATION</b>	<b>25</b>
3.1	CONFIGURATION TOOLS	25
3.2	CONFIGURATION OVERVIEW	25
<b>CHAPTER 4</b>	<b>SYSTEM OPERATION</b>	<b>29</b>
4.1	SYSTEM OVERVIEW	29
4.1.1	<i>Communications</i>	29
4.1.2	<i>Redundancy</i>	30
4.1.3	<i>I/O Scans</i>	31
4.1.4	<i>Alarms</i>	32
<b>CHAPTER 5</b>	<b>DIAGNOSTICS</b>	<b>33</b>
5.1	STATUS DATA	33
5.1.1	<i>PROFINET Status Data</i>	33
5.1.2	<i>Genius Status Data</i>	34
5.2	MODULE LED INDICATORS	34

# Contents

---

5.3	POWER-UP .....	35
5.3.1	<i>Problems during Power-up</i> .....	35
5.3.2	<i>Transitioning from Firmware Update Mode to Operational Mode</i> .....	35
5.4	MODULE FAULTS IN THE RX3i I/O FAULT TABLES .....	36
5.4.1	<i>Fault Types Reported to the RX3i Controller I/O Fault Table</i> .....	37
5.4.2	<i>Clearing the RX3i Fault Tables</i> .....	39
<b>CHAPTER 6</b>	<b>COMMREQ/DATA_INIT_COMM PROGRAMMING .....</b>	<b>41</b>
6.1	COMMREQS AND PASSWORDS .....	41
6.2	PROGRAMMING FOR A COMMREQ COMMUNICATION REQUEST .....	41
6.3	COMMREQ COMMAND BLOCK FORMAT .....	42
6.3.1	<i>COMMREQ Command Block Contents</i> .....	43
6.3.2	<i>COMMREQ Commands Supported by the Genius Gateway (GCG001)</i> .....	44
6.3.3	<i>COMMREQ Command Block Quick Reference</i> .....	45
6.3.4	<i>Mechanics of the COMMREQ Instruction</i> .....	46
6.3.5	<i>Comparison: COMMREQ vs Data_Init_Comm</i> .....	51
6.3.6	<i>COMMREQ Differences: Genius Bus Controllers and Genius Gateway</i> .....	52
6.4	COMMREQ DESCRIPTIONS AND FORMATS .....	53
6.4.1	<i>COMMREQ #1: Pulse Test Command</i> .....	53
6.4.2	<i>COMMREQ #2: Read Configuration Command</i> .....	54
6.4.3	<i>COMMREQ #3: Write Configuration Command</i> .....	55
6.4.4	<i>COMMREQ #4: Read Diagnostics Command</i> .....	56
6.4.5	<i>COMMREQ #5: Clear Circuit Fault Command</i> .....	57
6.4.6	<i>COMMREQ #6: Clear All Circuit Faults Command</i> .....	57
6.4.7	<i>COMMREQ #7: Assign Monitor Command</i> .....	58
6.4.8	<i>COMMREQ #11: Read Device Command</i> .....	59
6.4.9	<i>COMMREQ #12: Write Device Command</i> .....	60
6.4.10	<i>COMMREQ #19: Read Identification</i> .....	61
6.4.11	<i>COMMREQ #20: Write Point Command</i> .....	62
6.4.12	<i>COMMREQ #21: Read Block I/O Command</i> .....	63
6.4.13	<i>COMMREQ #22: Read Map Command</i> .....	67
6.4.14	<i>COMMREQ #23: Write Map Command</i> .....	68
6.4.15	<i>COMMREQ #24: Read Data Command</i> .....	69
6.4.16	<i>COMMREQ #25: Write Data Command</i> .....	69

## Figures

Figure 1: PLC System Using Genius Gateway GCG001.....	2
Figure 2: GCG001 Module.....	3
Figure 3: Genius Gateway GCG001 Front Panel View .....	5
Figure 4: GCG001 Panel Mount Diagram .....	6
Figure 5: Application Relationships between PROFINET Controller & Genius Gateway .....	7
Figure 6: Real-Time & Non-Real-Time Data Types.....	8
Figure 7: PLC - GCG - Genius Scan Cycles .....	9
Figure 8: Rear View of GCG001 .....	17
Figure 9: GCG001 Power Connector.....	17
Figure 10: Daisy Chain Genius Bus Wiring.....	18
Figure 11: Genius Bus Wiring for Bus Termination .....	18
Figure 12: PROFINET Discovery Screenshot .....	19
Figure 13: GCG001 Firmware Upgrade ZIP File UnZIPPed to SD Card .....	22
Figure 14: Hardware Configuration Expanded Tree .....	25
Figure 15: Change Module List for Genius Gateway GCG001.....	26
Figure 16: Populating the Genius IO Devices to be Controlled by the Genius Gateway .....	27
Figure 17: Populating Slots in S90-70 Rack Controlled by Remote I/O Scanner (BEM733) .....	27
Figure 18: Genius Gateway Configuration Example .....	28
Figure 19: Genius Hot Standby Redundancy .....	30
Figure 20: PROFINET Media Redundancy.....	31
Figure 21: Gateway Status Data.....	33
Figure 22: Genius Status Data .....	34
Figure 23: Genius Discrete Block "No Load Present" Fault Display (example).....	38
Figure 24: Genius Analog Block "Over Range" Fault Display (example) .....	39
Figure 25: Ladder Logic to Clear Circuit Fault .....	50
Figure 26: Data_Init_Comm to Clear Circuit Fault .....	51



# Chapter 1 *Introduction*

This manual describes the RX3i Genius Communications Gateway, which acts as a gateway between PROFINET and Genius I/O. Introductory material may be found in this chapter. Chapter 2 provides installation and set-up information. Chapter 3 provides configuration instructions. Chapter 4 describes system operation. Chapter 5 provides diagnostic information. Chapter 6 covers the use and format of ladder logic COMMREQ instructions.

## 1.1 *Manual Revisions*

Rev	Date	Description
A	Mar 2015	<ul style="list-style-type: none"> <li>Behaviour of GCG001 with respect to input references associated with a faulted block is described in Section 1.8, with workaround in Section 4.1.4.</li> <li>Correction to Figure 19: Genius Hot Standby Redundancy to indicate CPU type is CRU and RMX modules are required.</li> <li>Clear All Faults can now be dispatched to all blocks on the bus in a single command. See Section 6.4.6.</li> </ul>
-	Jun 2014	Original Issue



## 1.2 Description

The RX3i Genius Communications Gateway, IC695GCG001 (or GCG001), interfaces Genius IO devices on a Simplex Genius Serial Bus to a GE Intelligent Platforms PROFINET IO Controller.

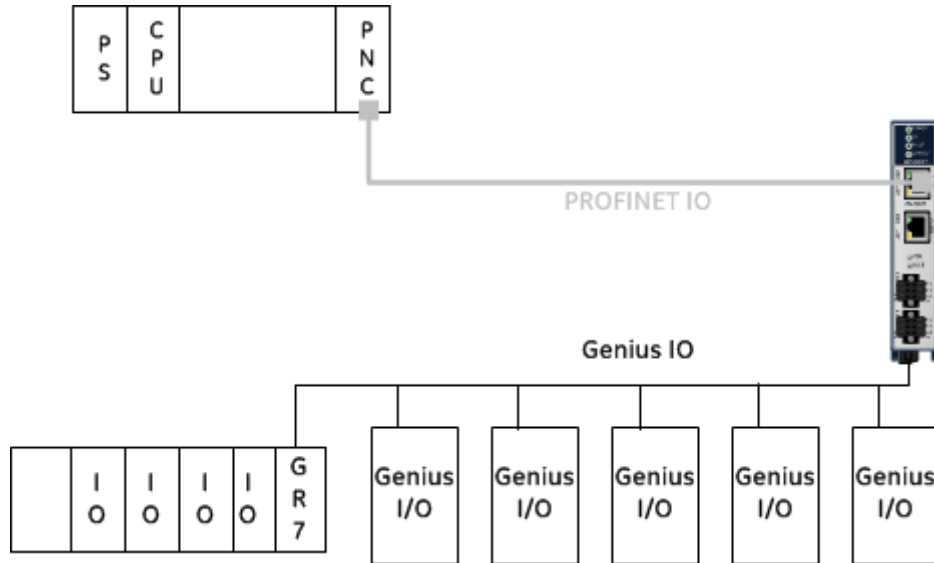

Figure 1: PLC System Using Genius Gateway GCG001

The GCG001 operates as a Genius Bus Controller on a Genius network. It scans the Genius IO devices configured to it, retrieving input data and providing output data. It then exchanges that data with its configured PROFINET IO Controller over its Ethernet interfaces at the configured production rate. The GCG001 can manage communications for up to 31 Genius IO devices on a single Genius Serial Bus.

The GCG001 also operates as an "IO Device" on PROFINET, controlled by the PROFINET IO Controller (PNC001) to which it is attached. Thus, when correctly configured, the entire Genius Bus, including the GCG001 itself, becomes visible to the controlling PLC (in this case an RX3i). Note that the GCG001 operates only with GE PLC PROFINET IO Controllers.

PROFINET operates on an Ethernet network. If the Ethernet network or Genius serial bus communications are lost, the GCG001 manages IO states according to the individual module configurations.

Both PROFINET and Genius may be set up in Redundant configurations. These are discussed later in this manual.

## 1.3 Product Overview

Features of the GCG001 module include:

- Attachment of two RJ-45 Ethernet connections (Ports 1 & 2)
- Support for both star (switched) and linear (daisy-chained) network topologies
- Supports Ethernet Media Redundancy Protocol (MRP)
- LEDs to indicate Ethernet status (ACT & LINK)
- Attachment Genius bus connections (marked Genius A). Genius B connectors are inactive.
- Supports Genius Redundancy consisting of a single Genius bus with two GCG001 Gateways, one at SBA #30 and the other at SBA #31. No other form of Genius redundancy is supported.
- LED to indicate Genius Communications Status (COM)
- LED to indicate Genius Redundancy Status (Bus B) (inactive)
- LEDs to indicate module status (see module header)
- Panel-mount (typical)
- Optional mounting in RX3i expansion slot
- Cable tie-down loop on underside of module (at front)
- 24Vdc power connector on underside of module
- 0.2A maximum current draw
- Secure Digital (SD) Card Slot, accessible at rear of module
- Firmware load pushbutton, accessible at rear of module



Figure 2: GCG001 Module

**Note:** Although the hardware supports the 10/100BASE TX Ethernet standard, PROFINET IO over wired infrastructure must be 100Mbps full-duplex or faster. 10Mbps should not be used for PROFINET.

## 1.4 Specifications

### RX3i Genius Communications Gateway Specifications

<b>PROFINET Support</b>	PROFINET Version 2.3 Class A IO-Device
<b>CPU Compatibility</b>	RX3i CPE305/CPE310 with firmware version 8.15 or later RX3i CPU315/CPU320/CRU320 with firmware version 8.15 or later
<b>PNC001 Compatibility</b>	Firmware version 2.05 or later Note that the GCG001 cannot be used with any other PROFINET controllers.
<b>Proficy* Machine Edition Compatibility</b>	Machine Edition 8.0 or later
<b>Power Requirements</b>	External 24Vdc: ( $\pm 10\%$ ) 0.2A
<b>Operating Temperature Range</b>	0 to 60°C
<b>Number of Port Connectors</b>	Two RJ-45
<b>Local Area Network (LAN)</b>	IEEE 802.2 Logical Link Control Class I IEEE 802.3 CSMA/CD Medium Access Control 10/100 Mbps
<b>Status Data</b>	64 (two banks of 32 bits)
<b>Genius Bus Support</b>	Supports One Genius Bus. Genius A terminal is active; Genius B is inactive. Serial 1, Serial 2, Shield In and Shield Out, as marked. Up to 31 additional devices supported per Genius Bus. Selectable Baud Rate, per Genius specifications. Genius Hot Standby and Duplex Redundancy supported.
<b>HHM Compatibility</b>	IC66*HHM501
<b>Other Genius Compatibility</b>	See table in Section 1.9
<b>SD Card</b>	2GB or smaller. Not compatible with SDHC or SDXC cards.
<b>Configuration</b>	GSDML file is available on the Support website for download and import into Proficy Machine Edition. The GSDML supporting a firmware release is part of the firmware upgrade kit available on the Support website.
<b>Hot Swappable</b>	The Genius Gateway requires an external 24Vdc power supply and does not draw power from the Rx3i backplane. Swapping out the GCG001 will therefore not impact the PLC. However, this cannot be performed without disconnecting its power supply. If configured to support Genius Hot Standby, the loss of a single GCG001 will be tolerated; otherwise not.

For system standards, general operating specifications, and installation requirements, refer to the *PACSystems RX3i System Manual*, GFK-2314.

## 1.5 Controls and Indicators

Figure 3 shows the front of the module and identifies its controls and indicators.

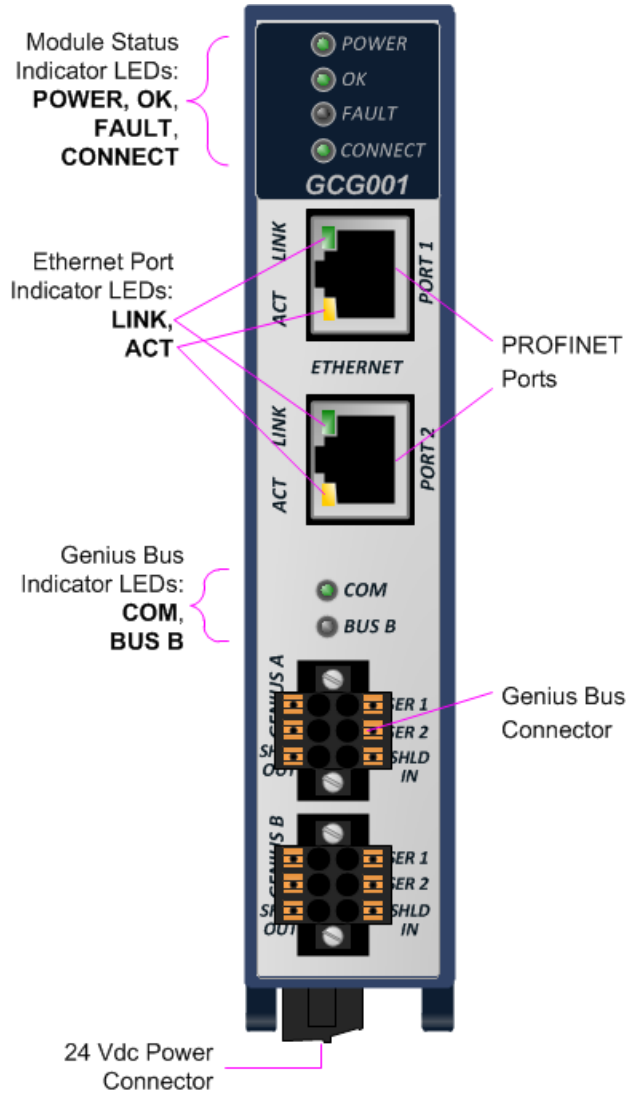

Figure 3: Genius Gateway GCG001 Front Panel View

## 1.5.1 Mounting

The GCG001 may either be panel-mounted or mounted in the rightmost slot (expansion slot) of an RX3i rack (IC695CHS012, IC695CHS016).

**Note:** The SD Card supplied with the GCG001 will have been installed at the factory. See section 2.4.1 for instructions for installing the SD Card when doing a retrofit. The presence of the SD Card should be checked before mounting the module.

**Note:** Clearance of 3 inches (75mm) must be provided above and below the module for proper ventilation and to permit cable access.

**Note:** External power must always be supplied to the module, regardless of which mounting arrangement is chosen. When rack-mounted, the GCG001 does not draw power from the RX3i Universal Backplane.

### RX3i Backplane Mounting

The GCG001 may be mounted in the rightmost slot (expansion slot) of an RX3i Universal Backplane.

The two captive M3.5 screws at the rear of the GCG001 align with mating tapped holes on the right side of the backplane, providing a convenient mounting location. When rack-mounted, the module does not make contact with the backplane connector.

### Panel-Mounting

Panel-mounting allows for mounting where no RX3i backplane slot is available. The two captive M3.5 machine screws on the GCG001 can be used for attaching the unit to a panel.

**Note:** The panel must have a minimum thickness of 2.4mm (0.094in).

1. Drill two mounting holes using the spacing shown in the drawing (at right) and tap for M3.5 (3.5 x 0.6mm).
2. Align the two mounting screws of the module with the mounting holes in the panel.
3. Using a Philips screwdriver, tighten the two screws to a maximum torque of 0.5 Nm (4.4 in-lbs).

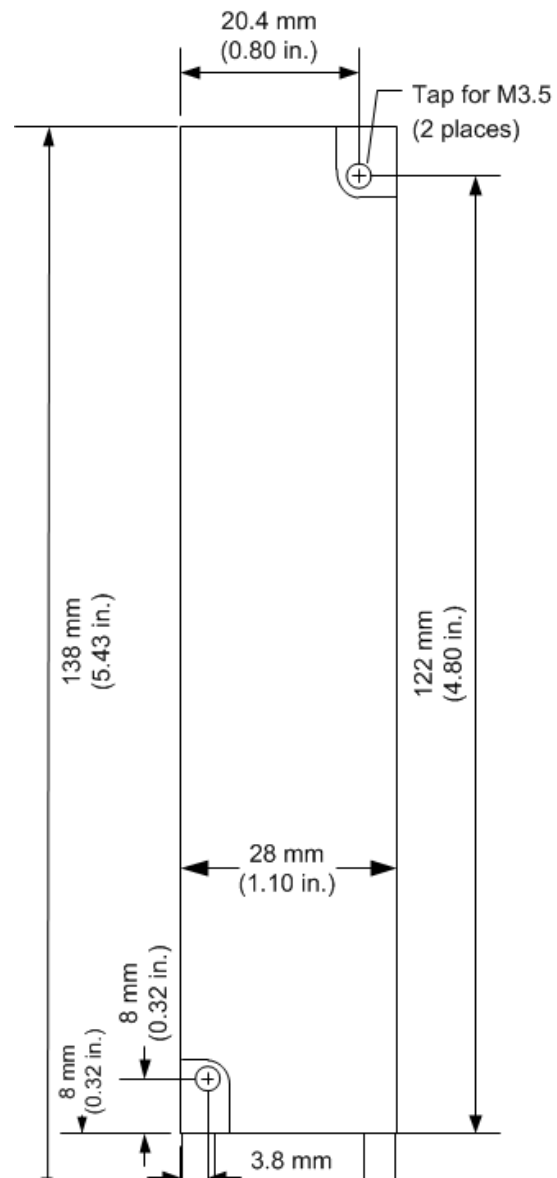

Figure 4: GCG001 Panel Mount Diagram

## 1.6 PROFINET Operation Overview

An RX3i Genius Communications Gateway (GCG001) uses PROFINET communications for data exchange with the PLC. As noted above, the data rate must be 100Mbps full-duplex or faster. The same network may be used for basic Ethernet communications, but use of a separate Ethernet network and RX3i Ethernet interface is recommended.

### PROFINET Communications

Communications on an RX3i PROFINET network use the standard PROFINET communications described in this section. Note, however, that the Genius Gateway GCG001 is constrained to work only with GE PROFINET PLC products.

### Application Relationships

Before a PROFINET IO-Controller can exchange data with a PROFINET IO-Device such as the GCG001, an Application Relationship (connection) must be established between the devices. The PROFINET IO-Controller automatically sets up the correct number and types of Application Relationship and Communication Relationship channels (see below) based on its Proficy Machine Edition (PME) configuration. Usually, only one Application Relationship is established per IO-Device.

### Communication Relationships within an Application Relationship

Within each Application Relationship, the PROFINET IO-Controller establishes the following types of Communication Relationships (CRs):

- **Record Data CRs** – always the first to be established within an Application Relationship. Record Data Communication Relationships are used for non-real-time transfers of data records such as startup parameter data, diagnostics data, identification data, and configuration data.
- **IO CRs** – used for the real-time, cyclic transfer of IO data
- **Alarm CR** – used for real-time, acyclic transfer of alarms and events

The illustration below represents an Application Relationship between a PACSystems RX3i PROFINET Controller and an RX3i Genius Gateway GCG001.

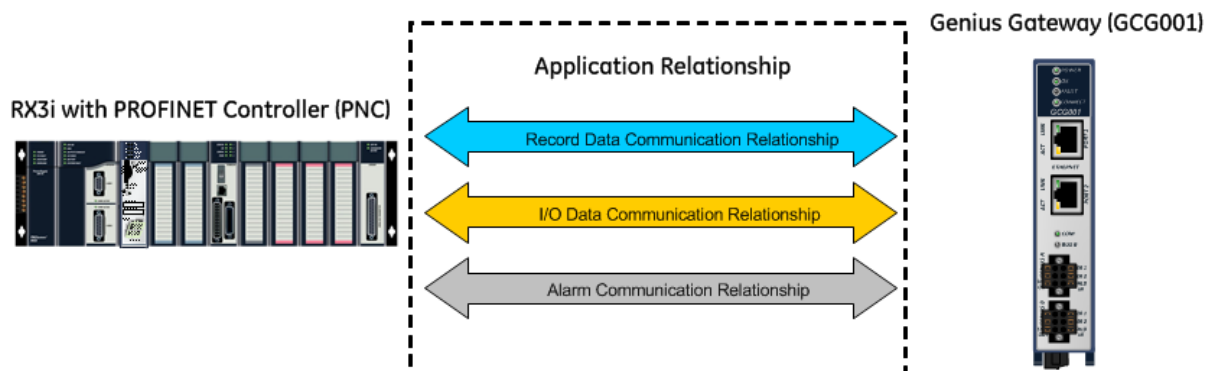

Figure 5: Application Relationships between PROFINET Controller & Genius Gateway

## Types of PROFINET Communications

Genius Communications Gateways use two types of PROFINET communication transfers: real-time and non-real-time. The illustration below shows real-time communications as solid lines and non-real-time communications as dashed lines.

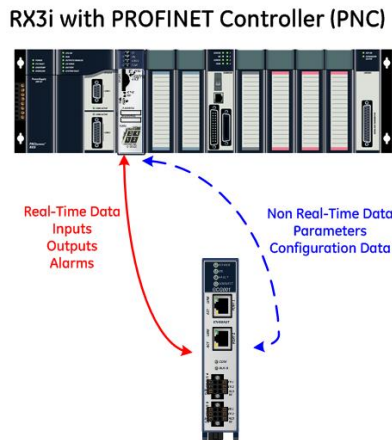

Figure 6: Real-Time & Non-Real-Time Data Types

- **Real-Time (RT) communication:** PROFINET real-time communication is used for time-sensitive data. A PROFINET IO-Controller (PROFINET Controller) and PROFINET IO-Device use two types of real-time communications to exchange data: cyclic communication and acyclic communication:
  - Real-time Cyclic communication is used to periodically transfer the application's input and output data. Cyclic communication occurs each PROFINET IO production cycle.
  - Real-time Acyclic communication is used to transfer non-periodic data such as alarms. Acyclic communication occurs only when needed.
- **Non-Real-Time (NRT) communication:** PROFINET non-real-time communication is used for less time-sensitive data such as configuration, parameterization, diagnostics, and identification data.

## Operations of the Genius Communications Gateway

The Genius Communications Gateway performs the following operations:

- Consumes PROFINET IO-Device configuration from the PROFINET IO-Controller over the PROFINET network.
- Scans input data from each Genius device it manages and produces that data to the PROFINET IO-Controller.
- Consumes the output data that it receives from the PROFINET IO-Controller and applies it to each Genius device it manages.
- Where needed, translates Genius Datagrams (background traffic) into PROFINET packages that are sent to the PROFINET Controller. This includes Datagrams that originated at the Genius Devices, such as Fault Reports.
- Translates PROFINET packages that are sent by the PROFINET Controller into Genius Datagrams. This includes Datagrams that originated at the PLC through use of COMMREQ or Data\_Init\_Comm instructions. For example, a COMMREQ is used to generate a Clear Fault Report datagram.

## IO Scanning

In the PACSystems RX3i PROFINET network, multiple IO cycles run asynchronously and independently. Figure 7) illustrates typical cycles in a system with an RX3i CPU with a PROFINET Controller module communicating with a Genius Communications Gateway. Cycles may be different for third-party devices.

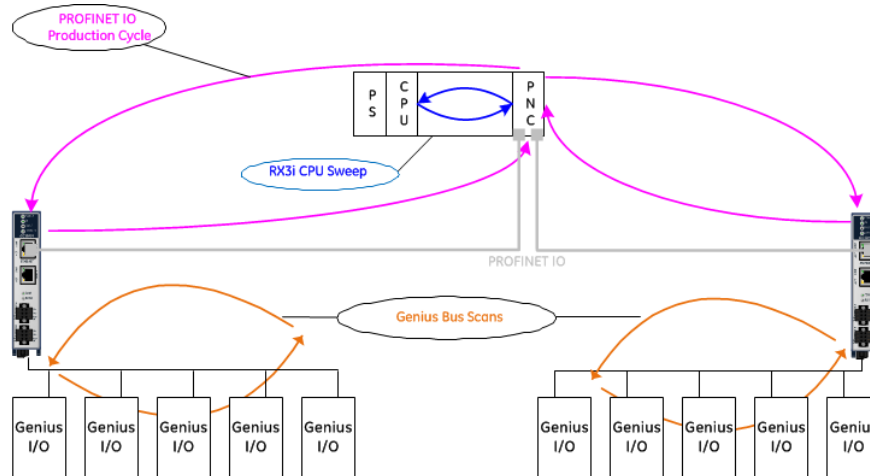

Figure 7: PLC - GCG - Genius Scan Cycles

- Genius IO-Device Scan:** In this example, each GCG scans all of its Genius devices. The GCG stores the devices' input data into its internal memory. Every time the GCG gets a turn on the Genius bus, it transmits the output data from its internal memory to each of the Genius devices. Note that the GCG001 supports only 153.6 kBaud std. and ext. data rates.
- 3<sup>rd</sup> party devices:** The transfer of IO data between an IO module and the PROFINET IO network is device dependent. Refer to the third party manufacturer documentation for specifics for a particular device.
- PROFINET IO Production Cycle:** Each PROFINET Controller and IO-Device publishes data from its internal memory onto the network at its scheduled PROFINET production cycle (Note: Production cycles between IO-Controllers and IO-Devices are not synchronized; each publishes at its configured update rate independently). The PROFINET Controller publishes output data received from the RX3i CPU to each IO-Device, and the IO-Device publishes input data from its memory to the PROFINET Controller.
- RX3i CPU Sweep:** The RX3i CPU Sweep includes both an input scan and an output scan. The CPU input scan retrieves the current input data being stored within the PROFINET Controller module. This input data is then available for use by the application logic. After the logic solution, the CPU output scan writes the outputs to the PROFINET Controller.



### **Media Redundancy Protocol Support**

PROFINET Media Redundancy Protocol (MRP) supports devices configured in a ring topology. MRP is specified as part of IEC62439 and has been adopted by the PROFINET specification, which provides for convenient configuration of the ring topology and necessary parameters. Like PROFINET IO data, Media Redundancy Protocol operations are not routable between different IP subnets.

Each device within an MRP ring has two physical pathways to the IO-Controller. To connect to the ring, each device requires an integrated switch with at least two external ports (ring ports) that support MRP. Devices that are not MRP-capable can be connected to a device in the ring (i.e., an MRP-capable switch in the ring), but they should not be in the ring themselves. The redundancy capability offered by the ring topology only extends to the devices on the ring that are MRP-capable and enabled.

One of the devices on the ring must be configured as the Media Redundancy Manager (MRM), and all the other devices must be configured as Media Redundancy Clients (MRCs). The GCG001 can be configured as an MRC. Configuring the GCG as an MRC alters how the Ethernet ports connect to the network. They attempt to indicate their state to the MRM before allowing traffic to flow between the ports and close the ring topology through the internal switch. They also send out notifications to the MRM when a port is lost. Operation of the GCG001 is otherwise unchanged.

The MRP configuration is stored in non-volatile storage in the GCG001 and activated immediately upon powering up. Non-volatile storage is updated as part of a connection with the IO-Controller. A PROFINET Discovery & Configuration Protocol (DCP) Reset disables MRP Client operation and updates non-volatile storage. The current state of the MRP configuration is provided as part of the GCG's Gateway Status Bits which are accessible to user application logic. Refer to the description of Gateway Status Bits in Section 5.1.1 for further details.

Fast ring-break detection is not fully functional until all MRP clients have received their MRP configuration. For a discussion of ring-break detection, see "Bumpless Operation with MRP" below.

#### **Bumpless Operation with MRP**

The GCG001 supports bumpless operation under MRP.

## **1.7 System Limits**

IO-Controllers have limitations on the size of the system they support. One of these limits is the number of PROFINET sub-modules supported. The GCG001 uses four sub-modules: two for basic operation and two built-in port sub-modules that are always configured. Each Genius device attached to a GCG001 uses one additional sub-module.

Other limitations, such as the configuration and IO sizes are specific to the configuration options chosen. Note that not every combination of options is supported in every system. If the configuration uses all Genius bus slots with a corresponding large device count, the memory of the IO-Controller system will be a limiting resource.

See GFK-2571 for actual limits in the RX3i PROFINET Controller (PNC001).

See GEK-90486, *Genius I/O System and Communications User's Manual* for information on how much I/O, and which type of I/O, need to be allocated to Genius devices,

Machine Edition (v8.0 or later) takes into account both system limits and I/O allocation.

## 1.8 Operational Differences vs. Genius Bus Controller

Persons migrating from a Genius environment where the Genius Bus Controller performs functions similar to those of the GCG001 will want to be aware of the following differences:

1. COMMREQ function block SYSID and Task parameters change. SYSID is now the rack & slot of the PNC connected to the GCG001. Task is now 132.
2. COMMREQ data blocks are different, mainly due to added PROFINET Device Number and expansion of memory address fields from one word to two words. See COMMREQ summary in Section 6.3.3.
3. Pulse Test and Assign Monitor COMMREQs do not support Genius bus address of 255 to send messages to all blocks.
4. COMMREQ commands: GCG001 does not support all datagrams. See section 6.3.2 for a corresponding list of supported COMMREQs.
5. GCG001 supports hot-standby and duplex redundancy modes only. No support for dual-bus redundancy.
6. GCG001 can be assigned to bus addresses 30 and 31 only.
7. GCG001 does not support Field Control, VersaMax GNIU, GENI, GENA, or PCIM.
8. GCG001 does not support 76.8K and 38.4K baud rates.
9. Due to PROFINET limitations, fault contact operation has changed. Whenever there is a fault on a single channel of a Genius block, all fault contacts associated with that Genius block will become active. All faults on that device must be cleared before any of the fault contacts will de-energize.
10. Genius faults routed through a GCG001 appear as PROFINET faults to the CPU. The same fault routed through a Genius Bus Controller will present a different error code.
11. Whenever a Genius block encounters a circuit fault on one or more points or channels, the GCG001 causes all of the input references associated with that block to either hold last state or go to default values until such time as the fault is cleared. See the Alarms discussion in section 4.1.4 for a work-around to this behaviour.

## 1.9 Supported Genius Devices

The following Genius devices are compatible with the GCG001 Genius Communications Gateway

Catalog Number	Description
IC660BBA020	24/48Vdc 4-Input/2-Output Analog Block
IC660BBA021	24/48Vdc RTD Input Block
IC660BBA023	24/48Vdc Thermocouple Input Block
IC660BBA024	24/48Vdc Current-Source Analog Block
IC660BBA025	24/48Vdc Current-Source Output Block
IC660BBA026	24/48Vdc Current-Source Input Block
IC660BBA100	115Vac 4-Input/2-Output Analog Block
IC660BBA101	115Vac RTD Input Block
IC660BBA103	115Vac/125Vdc Thermocouple Input Block
IC660BBA104	115Vac/125Vdc Current-Source Analog Block
IC660BBA105	115Vac/125Vdc Current-Source Output Block
IC660BBA106	115Vac/125Vdc Current-Source Input Block
IC660BBD020	24/48Vdc 16-Circuit Source I/O Block
IC660BBD021	24/48Vdc 16-Circuit Sink I/O Block
IC660BBD022	24Vdc 16-Circuit Source I/O Block
IC660BBD023	24Vdc 16-Circuit Sink I/O Block
IC660BBD024	12/24Vdc 32-Circuit Source I/O Block
IC660BBD025	5/12/24Vdc 32-Circuit Sink I/O Block
IC660BBD101	115Vac Low-Leakage 8-Circuit Grouped Block
IC660BBD110	115Vac 16-Circuit Input Block
IC660BBD120	High-Speed Counter Block
IC660BBR100	16-Circuit Relay Block, Normally-Closed
IC660BBR101	16-Circuit Relay Block, Normally-Open
IC660BBS100	115Vac/125Vdc 8-Circuit Isolated I/O Block
IC660BBS102	115Vac/125Vdc 8-Circuit Isolated I/O Block
IC660BBS103	115Vac/125Vdc 8-Circuit Isolated I/O Block Without Failed Switch Diagnostic
IC697BEM733†	Series 90-70 Remote I/O Scanner (GR7)

†See GFK-0579 Chapter 1 for a list of S90-70 modules supported by BEM733.

## 1.10 Glossary

AR	PROFINET Application Relationship
CR	PROFINET Communication Relationship
DCP	PROFINET Discovery & Configuration Protocol
GCG	Genius Communications Gateway (specifically GCG001)
GENA	Genius Network Adaptor
GENI	Genius Network Interface
GNIU	Genius Network Interface Unit
GR7	Series 90-70 Remote I/O Scanner (IC697BEM733)
GSDML	General Station Description Markup Language
HHM	Genius Hand-Held Monitor
LAN	Local Area Network
LED	Light Emitting Diode
MRC	Ethernet Media Redundancy Client
MRM	Ethernet Media Redundancy Manager
MRP	Ethernet Media Redundancy Protocol
NRT	Non-Real-Time PROFINET Communication
PCIM	Personal Computer Interface Module
PME	Proficy Machine Edition
PNC	PROFINET Controller
PPV	PLC Protocol Variables
RT	Real-Time PROFINET Communication
SBA	Genius Serial Bus Address
SD	Secure Digital Card Slot
STP	Shielded Twisted Pair
UTP	Unshielded Twisted Pair

## 1.11 References

GEK-90486-1	<i>Genius I/O System and Communications User's Manual</i>
GEK-90486-2	<i>Genius I/O Discrete and Analog Blocks User's Manual</i>
GFK-0579	<i>Series 90-70 Remote I/O Scanner User's Manual</i>
GFK-2222	<i>PACSystems RX3i and RX7i CPU Reference Manual</i>
GFK-2314	<i>PACSystems RX3i System Manual</i>
GFK-2571	<i>PACSystems RX3i PROFINET IO-Controller Manual</i>
GFK-2892	<i>PACSystems RX3i Genius Communications Gateway Module User Manual</i>
GFK-2900	<i>PACSystems RX3i Genius Communications Gateway Module Important Product Information</i>

User manuals, product updates and other information sources are available on the Support website, <http://www.ge-ip.com/support>, under Controllers and IO, RX3i Controllers



## Chapter 2 *Installation*

This chapter provides instructions for installing the module. The following topics are covered.

- Pre-Installation check
- Module installation and removal
- Port connections
- LED indications
- Firmware updates

For additional information about RX3i system installation, see the *PACSystems RX3i System Manual*, catalog number GFK-2314.

For additional information about PROFINET installation and configuration, see GFK-2571 for the *RX3i PROFINET Controller*. You will also need Proficy Machine Edition (PME) configuration and programming software, version 8.0 or later.

### 2.1 *Pre-Installation Check*

Upon receiving your RX3i equipment, carefully inspect all shipping containers for damage. If any part of the system is damaged, notify the carrier immediately. The damaged shipping container should be saved as evidence for inspection by the carrier.

As the consignee, it is your responsibility to register a claim with the carrier for damage incurred during shipment. GE Intelligent Platforms will cooperate fully with you, however, should such action be necessary.

After unpacking the RX3i equipment, record all serial numbers. Serial numbers are required if you should need to contact Customer Care during the warranty period. All shipping containers and all packing material should be saved should it be necessary to transport or ship any part of the system.

Verify that all components of the system have been received and that they agree with your order. If the system received does not agree with your order, contact Customer Care.

If you need technical help, contact Technical Support. For phone numbers and email addresses, see the **Contact Information** page in the front of this manual.

### 2.2 *Installation Location*

This product is primarily intended for use with the RX3i system. Its components are considered open equipment (having live electrical parts that may be accessible to users) and must be installed in an ultimate enclosure that is manufactured to provide safety. At a minimum, the enclosure shall provide a degree of protection against solid objects as small as 12mm (e.g. fingers). This equates to a NEMA/UL Type 1 enclosure or an IP20 rating (IEC 60529) providing at least a pollution degree 2 environment. For details about installing RX3i rack systems, refer to GFK-2314, *PACSystems RX3i System Manual*.

## 2.3 Installation in Hazardous Areas

The following information is for products bearing the UL marking for Hazardous Areas or ATEX marking for explosive atmospheres:

### **CLASS 1 DIVISION 2 GROUPS ABCD**

- This equipment is an open-type device and is meant to be installed in an enclosure suitable for the environment that is only accessible with the use of a tool.
- Suitable for use in Class I, Division 2, Groups A, B, C and D Hazardous Locations, or nonhazardous locations only.

---

### **Warning**



**EXPLOSION HAZARD - SUBSTITUTION OF COMPONENTS MAY IMPAIR SUITABILITY FOR CLASS I, DIVISION 2.**

**WHEN IN HAZARDOUS LOCATIONS, TURN OFF POWER BEFORE REPLACING OR WIRING MODULES; AND**

**DO NOT CONNECT OR DISCONNECT EQUIPMENT UNLESS POWER HAS BEEN SWITCHED OFF OR THE AREA IS KNOWN TO BE NONHAZARDOUS.**

---



---

### **Warning**

**EXPLOSION HAZARD - USB PORT IS ONLY FOR USE IN NONHAZARDOUS LOCATIONS, DO NOT USE UNLESS AREA IS KNOWN TO BE NON-HAZARDOUS.**

---

### 2.3.1 ATEX Zone 2

The module must be mounted in an enclosure certified in accordance with EN60079-15 for use in Zone 2, Group IIC and rated IP54. The enclosure shall only be able to be opened with the use of a tool.

### 2.3.2 ATEX Marking

 II 3 G Ex nA IIC T4 X Ta: 0 - 60C

## 2.4 Module Installation

### 2.4.1 Install SD Card

The SD card slot is designed to support a Secure Digital (SD) non-volatile memory card in standard capacity format. This optional card has two distinct uses: (1) backup storage of some key PROFINET configuration data and (2) loading new GCG001 module firmware. Insert the SD Card into its slot at the rear of the GCG001 before mounting the module, as shown in Figure 8.

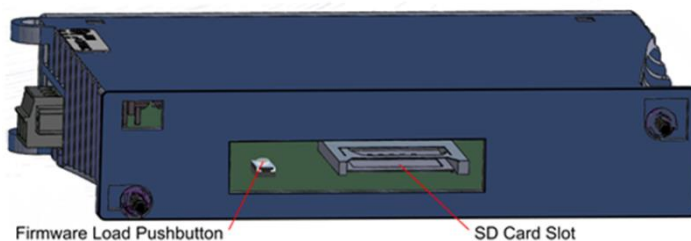

Figure 8: Rear View of GCG001

When shipped from the factory, the SD card will have been pre-installed. It will have been programmed with the then-current version of the firmware for the GCG001. In the event the firmware on the SD card needs to be updated, see section 2.7. Note that the firmware upgrade should be performed before mounting the module.

### 2.4.2 Mounting the GCG001

The GCG001 is designed to mount

- a) In the expansion slot of an RX3i Universal Backplane, or
- b) It may be panel-mounted.

In both cases, at least 75 mm (3 in.) must remain clear above and below the module to allow for convection cooling. See section 1.5.1 for mounting details.

Once the module has been mounted, connect 24Vdc power via the connector on the underside of the module, connect PROFINET via the RJ-45 connectors and the Genius bus via twisted pair cable. Note that only the Genius A terminal block is to be used. The Genius B terminal block is inactive, as is the "Bus B" LED. Each connection is described below.

Once all connections are in place, it will be necessary to configure PROFINET. This is also discussed below.

#### Power Connection

The module requires a user-supplied 24Vdc ( $\pm 10\%$ ) power source wired to the removable screw-terminal block located on the bottom of the module. Connector pin-outs are identified on the module, as indicated at right. The module draws 0.2 A maximum current.

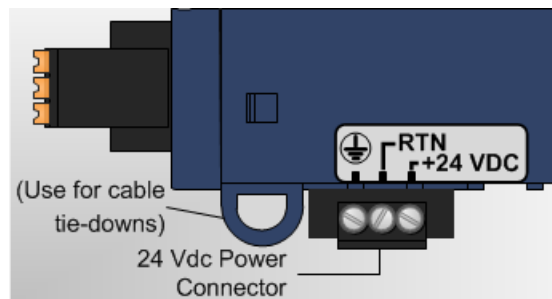

Figure 9: GCG001 Power Connector



## Grounding

For proper operation, always connect the GCG001 ground terminal (see Figure 9) to earth ground. The panel to which the GCG001 module is mounted, or the RX3i Universal Backplane to which it is mounted, must have a safety ground connection to protective earth. This ground wire must be at least 1.5 mm<sup>2</sup> (16 AWG).

- Connect the frame ground connection on the power plug to protective earth.
- Terminate all ground wires at the same grounding point.
- Make all ground wires as short as possible.
- Where the grounding terminal contacts a painted enclosure panel, scrape the paint away down to clean, bare metal to ensure good contact.

## PROFINET Connection

Attach the PROFINET via one or both of the RJ-45 connectors provided (Port 1 & Port 2). Various configurations are possible. Refer to the manual for the PROFINET controller used in the application (GFK-2571 for the RX3i PROFINET Controller).

## Genius Bus Connection

The GCG module is equipped with one active six-terminal Genius Serial Bus connector (Genius A). The Genius B terminal block is not to be used.

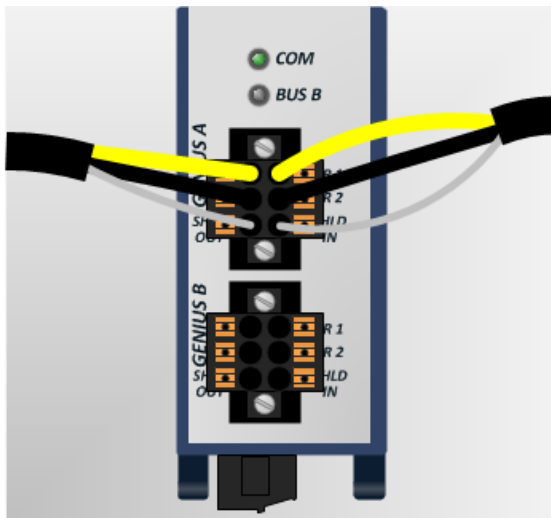

Figure 10: Daisy Chain Genius Bus Wiring

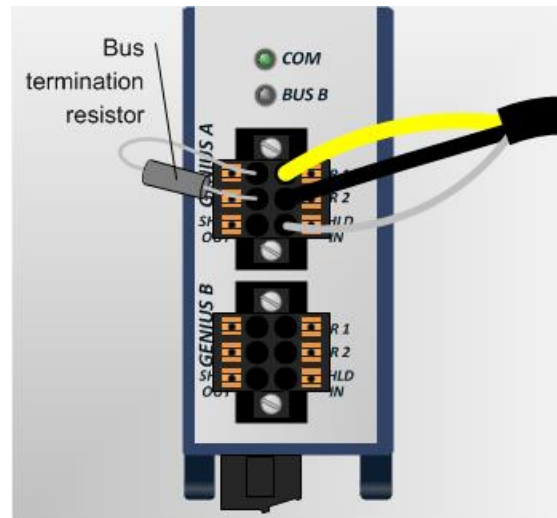

Figure 11: Genius Bus Wiring for Bus Termination

Two terminals each are provided on a removable terminal block for Serial 1, Serial 2, and Shield connections. The figure (above left) shows the Genius connection continuing through the connector block (daisy chain).

Whenever the Genius bus is terminated at the GCG001, a bus termination resistor should connect Serial 1 to Serial 2, with SHLD IN unterminated, (as shown above right). The value of the termination resistor must match the impedance of the Genius Bus cable.

Note that whenever the GCG001 Genius terminal blocks are removed from the faceplate, the continuity of the Genius Bus is disrupted.

## PROFINET Configuration

Once all connections are in place, it will be necessary to set up the PROFINET configuration. This requires use of the PC-based *PROFINET Discovery* tool. Be sure your PC is connected to the same PROFINET network and interrogate the network to discover what is connected, as shown in the following screen-shot.

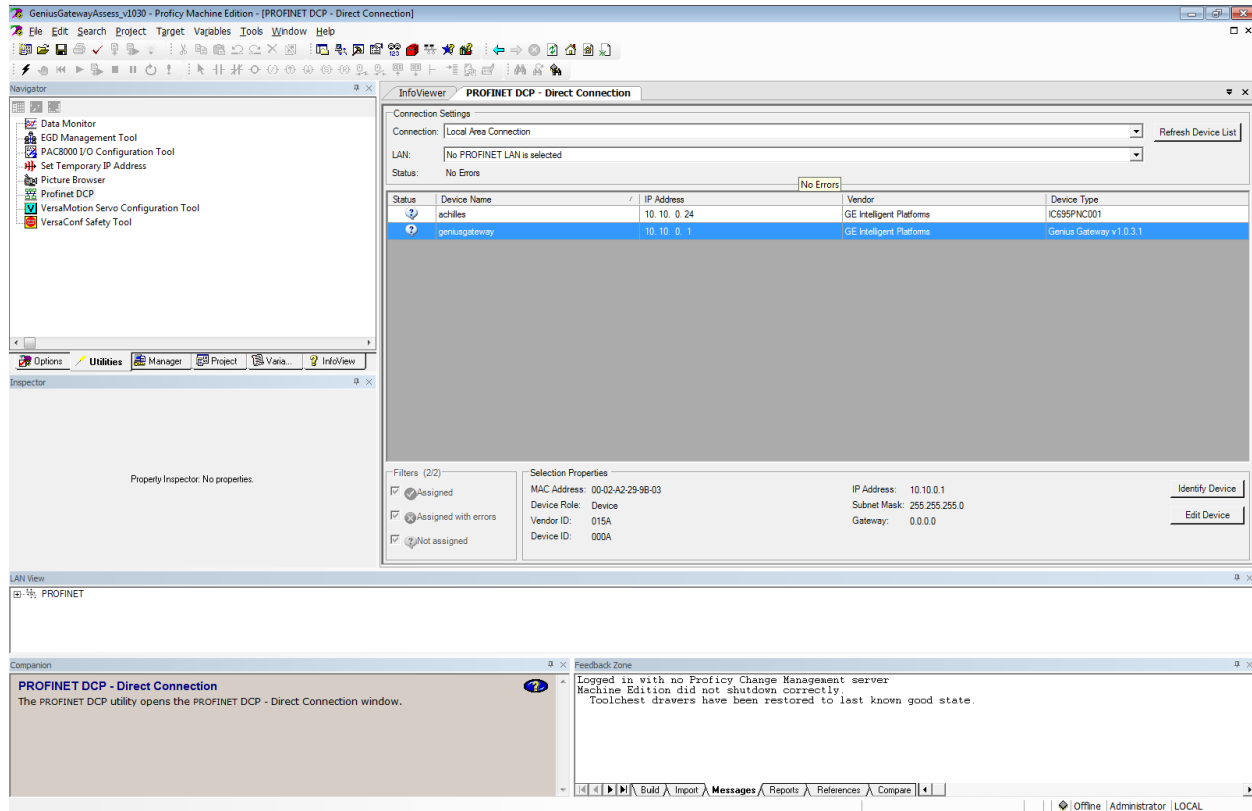

Figure 12: PROFNET Discovery Screenshot

Initially, the out-of-the box GCG001 will not have a name assigned. Select the row containing the GCG001, then click on the *Edit Device* button in order to assign a unique name.

Configuration tools and procedures are discussed in detail in Chapter 3.



### 2.4.3 GCG001 Module Removal

- Power down the external 24Vdc source
- Remove the Power connector from the underside of the GCG001 module
- Disconnect the RJ-45 PROFINET connector(s)
- Remove the Genius A terminal blocks
- While holding the GCG001, loosen the two captive M3.5 screws that hold the module in place, then pull away from the mounting surface. Note that, if mounted to an RX3i rack, there is no pivot attachment or backplane connection to the rack.
- The SD Card may be transferred from the removed GCG001 to another (successor) GCG001. This permits the PROFINET configuration of the removed module to be transferred to the successor module.
- Once the successor module has been mounted, the original Power, PROFINET and Genius connections may be restored to it.





### 2.4.4 Light-Emitting Diode (LED) Indications

The four LEDs in the module header provide a visual indication of the GCG001 module status.



**POWER** – indicates the presence of power to the module.

	Green, ON steady	Power supply is good.
	OFF	Power supply is off or not good.



**OK** – indicates GCG001 readiness to perform normal module operations.

	Green, ON steady	Module able to perform normal operations.
	Green/Amber, blinking	Module loading main operating system
	Amber, ON steady	Module loading boot-loader operating system
	OFF	Module has an unrecoverable fault or power is not applied.

**FAULT** – indicates the detection of faults by the module.



	OFF	No faults present.
	Red, blinking 2Hz	DCP Device Identification Signal received on PROFINET.
	Red, ON	A fault or other PROFINET diagnostic data exists on the Gateway

**CONNECT** – indicates status of the connection to a PROFINET controller.



	OFF	One or more connections with GE Intelligent Platforms PROFINET Controllers have been established to this device.
	Red, blinking	Device trying to connect to a controller. Continuous if device has not been assigned a valid station name.
	Red, ON	No PROFINET Controller connection

The two LEDs associated with each Ethernet port (used here as PROFINET ports) are labelled ACT and LINK. These LEDs provide information about activity on that particular port.

**PORT 1, PORT 2 LINK** – indicates connection status on Ethernet ports.





	Green, ON steady	Ethernet connection established
	OFF	No Ethernet connection

**PORT 1, PORT 2 ACT** – indicates activity on PROFINET ports.

	Amber, blinking	Communications occurring on port
	OFF	No communication

The two LEDs located directly above the Genius connectors provide information about the Genius bus. Since Genius Bus B is not active, no activity is expected on that bus.

**COM** – indicates the status of Genius Bus communications.

	Green, ON steady	The Genius Bus is configured and operating properly.
	Green, blinking	A Genius Bus error has been detected.
	OFF	The Genius Bus has failed or no Genius Bus configuration has been received.
<b>BUS B</b> – indicates activity on the Genius B port.		
	Green, blinking	Genius B port activity (not expected)
	OFF	No Genius B port activity

## 2.4.5 Fault Notifications

Powering up or down, or connecting/disconnecting the GCG001 from the controlling PROFINET device will have effects specific to the particular controlling device. The discussion below relates to using the RX3i PROFINET Controller as the controlling device.

Removing a GCG001 from the PROFINET network causes a *Loss of Device* fault for the GCG001 itself and all Genius devices connected via that GCG001.

Adding a GCG001 to the PROFINET network causes an *Addition of Device* fault for the GCG001 itself and all Genius devices connected via that GCG001.

Note that when a GCG001 is replaced by a successor GCG001, it is important to ensure that the successor is configured for PROFINET in the same manner as its predecessor. The quickest way to ensure this is to remove the SD Card from the original and insert it into the successor GCG001.

## 2.5 Configuring the Genius Gateway to Operate with the RX3i CPU

- 1) Start the Machine Edition application, then open or create the project which will contain the GCG001 module.
- 2) Configuring the rack, power supply, CPU and PROFINET Controller in the Project tab of the Navigator
- 3) Follow the instructions in the *RX3i PROFINET Controller System Manual GFK-2571* for adding devices to the PROFINET IO Network. The GCG001 will be one of those devices.
- 4) Note that each IO Device connected to the GCG001 will be mapped per the RX3i PROFINET Controller configuration.

## 2.6 Ethernet Port Connections

As noted earlier, PROFINET IO operates at 100Mbps or higher (full duplex). The GCG001 Genius Gateway cannot operate at a data rate greater than 100Mbps. Thus, for normal operation, at least one port must be operated at 100Mbps. Other devices operating at 10Mbps may co-exist on that network, though this would not be typical.

Each Ethernet port the GCG001 module (see Figure 3) operates independently, so devices that operate at different speeds and/or duplex modes may be attached to the ports. Each port automatically detects the attached cable and functions properly with either straight-through or crossover cables.

**Note:** The module operates only in auto-negotiate mode. All PROFINET devices and switches that are connected to the module should be configured to use auto-negotiation.

### 2.6.1 RJ-45 Port Connections

The two RJ-45 ports on the GCG001 Genius Gateway can be used for PROFINET network connections or for general Ethernet communications on a 10BaseT or 100BaseTX IEEE 802.3 network; 1000BaseTX is not supported. If the port is connected to an external switch, hub, or repeater, up to 12 PROFINET nodes may be connected in a star wiring topology. Cables may be up to 100 meters in length. Cables for 100BaseTX must be data grade Category 5 or better unshielded twisted pair (UTP) or shielded twisted pair (STP). 10BaseT may be used for the general Ethernet traffic, but not for PROFINET communications.

## 2.7 Firmware Updates

Refer to the rear view of the GCG001 module shown in Figure 8 (above). Whenever the GCG001 firmware needs to be updated, remove the SD card from its slot at the rear of the module, then install the SD Card in your PC and copy the new firmware to the SD Card. The ZIP file containing the GCG001 firmware upgrade may be found on the GE Intelligent Platforms Product Support web-site <http://www.ge-ip.com/support>. UnZIP as shown below (Figure 13).

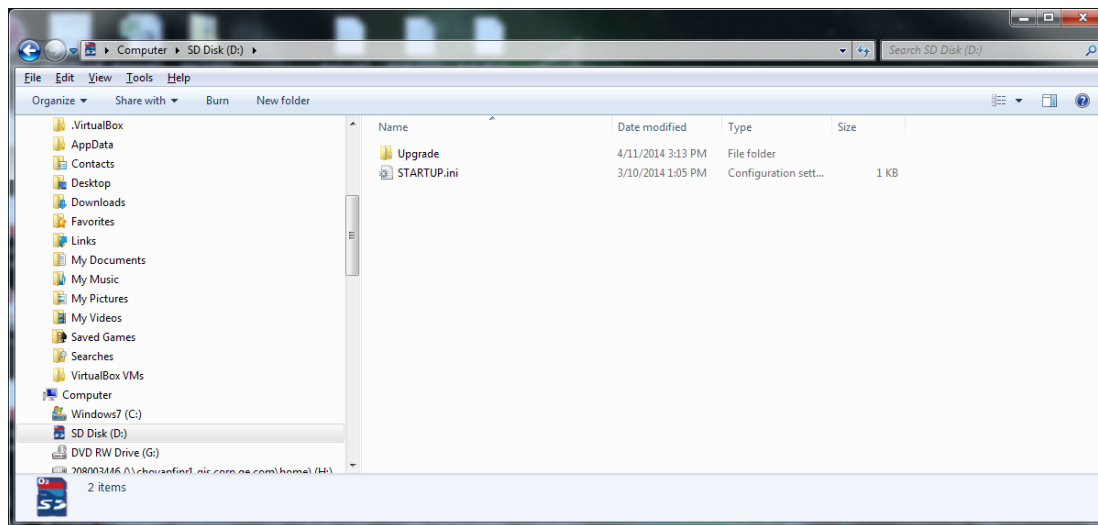

Figure 13: GCG001 Firmware Upgrade ZIP File UnZIPped to SD Card

After the SD card has received an update of the GCG001 firmware, install the SD card in its slot (see Figure 8). Note that the GCG001 must not be powered up while installing the SD Card. Next, while holding down the Firmware Load Pushbutton (see Figure 8), apply power to the module. This action causes the firmware to be copied from the SD Card to the GCG001 module itself. Continue holding the pushbutton until the OK LED turns amber, then release the pushbutton. When the OK LED turns green, the firmware has been loaded. Cycle power on the module and wait for the OK LED to turn green and steady. The module is then ready to be properly mounted (see section 1.5.1) .

## 2.8 Spare Parts

The following spare parts may be obtained directly from the indicated vendors:

GCG001 Usage	Manufacturer	Manufacturer P/N	Description	Contact Information
Power	Phoenix Contact	1763180	CONN TB PLUG 1X3 3.81MM TIN SCW LCKS BLK	<a href="http://www.phoenixcontact.com">www.phoenixcontact.com</a>
Genius Terminal Block	Weidmueller	127787000	CON,3X2,PLUG,W/SCREWS,SPRING CONN, TERM BLOCK	<a href="http://www.wiedmueller.com">www.wiedmueller.com</a>
Config Backup	Verbatim	44015	SD CARD, 2GB	<a href="http://www.verbatim.com">www.verbatim.com</a>



## Chapter 3 Configuration

The RX3i GCG001 Genius Gateway receives its configuration via its connected PROFINET I/O Controller (PROFINET Controller). The PROFINET Controller, in turn, is configured by a PROFINET I/O configuration tool. This tool will require a GSDML file for the GCG001 Genius Gateway. The RX3i GCG001 GSDML can be obtained from the GE Intelligent Platforms support website, <http://www.ge-ip.com/support>, using GCG001 as your search term.

For subsequent use, import the RX3i GCG001 GSDML file into the Tool Chest of Proficy Machine Edition.

### 3.1 Configuration Tools

- PACSystems RX3i CPU Firmware 8.00 or later.
- Proficy Machine Edition configuration and programming software, version 8.0 or later.
- Serial or Ethernet cable for connecting the Proficy Machine Edition programmer computer to the RX3i CPU.
- General Station Description Markup Language (GSDML) file for the GCG001, available from GE Intelligent Platforms support website, <http://www.ge-ip.com/support>.

### 3.2 Configuration Overview

The steps involved in configuring a GCG001 Genius Gateway are as follows:

1. If you haven't already done so, use Machine Edition to add a PROFINET IO-Controller (IC695PNC001) to the Hardware Configuration of the target control system.
2. Select the PNC001 in the **Navigator** window, then browse the module and the Local Area Network (LAN) configuration in the **Inspector** window, changing parameters as necessary for your system. Note that the GCG001 will operate at 100Mbps, and will cause the Network Speed to be auto-negotiated to this speed.
3. Right-click the PNC001, then select **Add IO-Device** to add the GCG001 as a connected device on the PROFINET LAN. In the PROFINET Device Catalog dialog that subsequently appears, select **Have GSDML...**, then browse to the location on your computer where the file is located, select it, and **Open**. As mentioned above, the GSDML can be conveniently stored in the PME Tool Chest.
4. Use PROFINET/DCP tool in Machine Edition to assign a name to the GCG001 Gateway so that the PROFINET Controller can connect to it and send its configuration. To do this, right-click the PNC001, then select **Launch Discovery Tool GCG001**. The tool will appear in a new InfoViewer tab entitled **PROFINET DCP – Direct Connection** (see Figure 12).

**Note:** This tool can also be activated from the **Utilities** tab in the **Navigation** pane by selecting **PROFINET DCP**.

5. With the GCG001 connected to the PNC001 via Ethernet cables, and both the RX3i rack and the GCG001 powered up, select **Refresh Device List**. Find the GCG001 in the list. If its **Device Name** does not match the **Device Name** configured on the PNC001, select the GCG001, then select **Edit Device**, change the **Device Name**, then **Exit**.

6. **GeniusGateway...** appears in the Device Catalog tree. Select **GeniusGateway**, then **OK**.

Figure 14: Hardware Configuration Expanded Tree

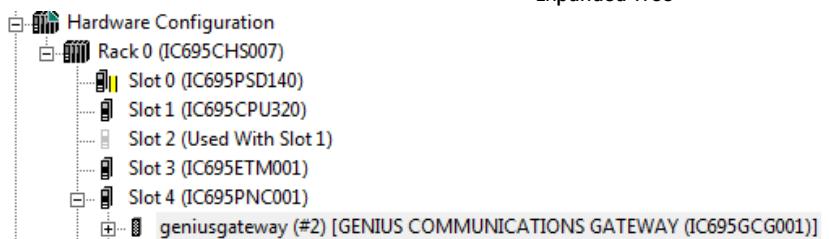
7. **geniusgateway...** now appears (Figure 14) as an IO device in the Hardware Configuration tree under the
 



PNC001. Within the **geniusgateway** branch, two daughter devices are displayed by default: the GCG (shown at slot 0 with its connected PNC) and the Gateway module itself at slot 31. You may drag the gateway to slot 30, if desired.

Note that slot 0, normally used by the Genius HHM, is not really consumed by the GCG001. The slot 0 indication for the GCG001 in the ME display should be ignored: it does not impact the SBA assignments on the Genius Bus.

**Note:** **geniusgateway...** is the default PROFINET **Device Name** that Machine Edition gives to a GCG001 in the Hardware Configuration under a PNC001. This **Device Name** *must match* that given to the module itself using the PROFINET/DCP (Discovery and Configuration Protocol) tool (see below). If there are multiple GCG001s on a PROFINET bus, each of the modules' **Device Names** must be unique. You can change it by selecting the device in the Navigator, then typing in a new name in the Inspector.

Example: GCG\_inside and GCG\_outside are acceptable **Device Names**.

8. Add Genius I/O devices to the Genius Bus by right-clicking **geniusgateway...** and selecting **Change Module List...** (see Figure 15). If the application is a retrofit of an existing Genius solution, be sure to set all I/O reference addresses to match those of the Genius configuration being incorporated. To ease confusion, it is also recommended that the Genius Devices be assigned the same serial bus addresses (Location column) as had been assigned in the system under retrofit.

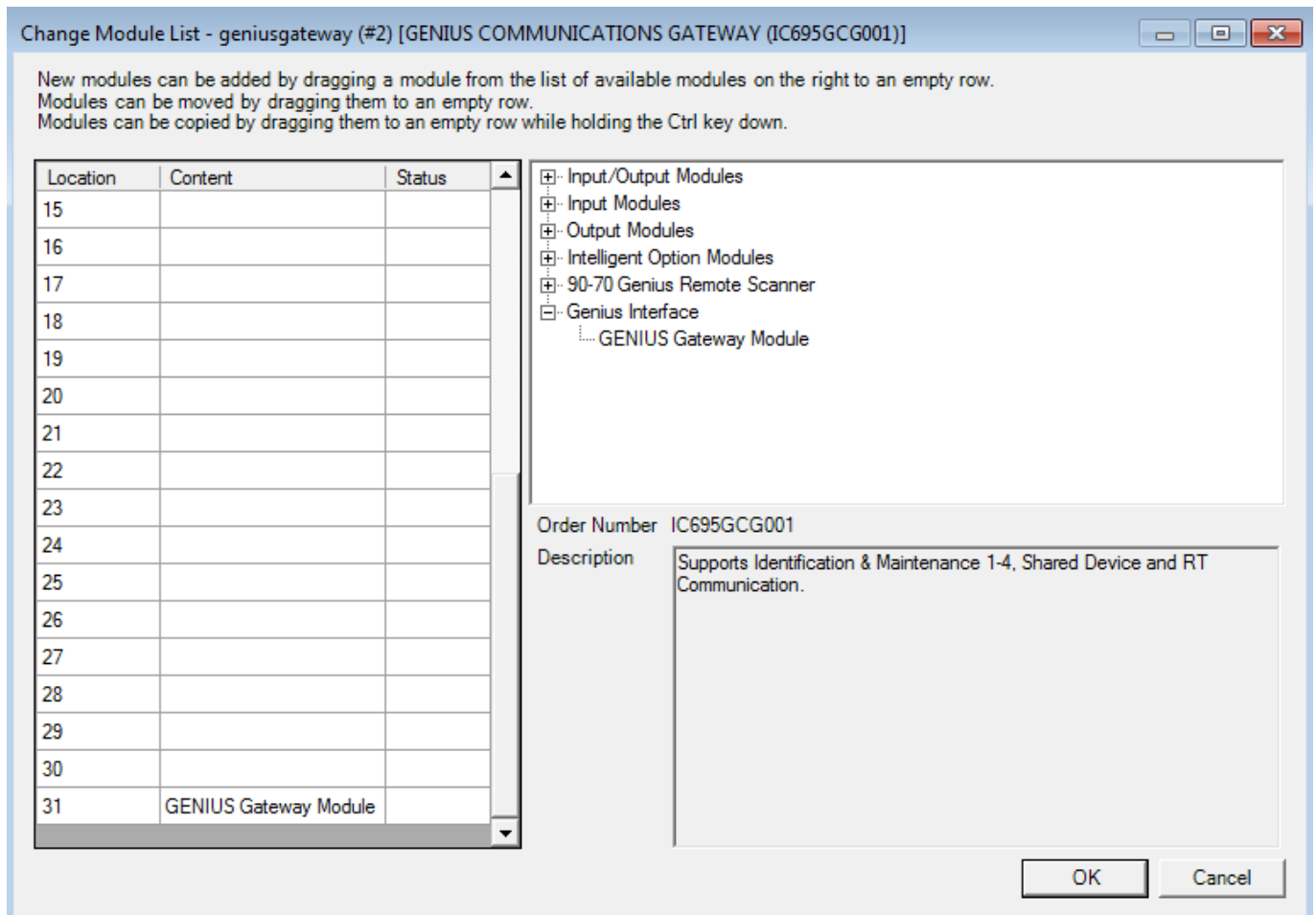

Figure 15: Change Module List for Genius Gateway GCG001

9. Select individual Genius I/O devices from the right-hand panel of Figure 15 and then drop them into the appropriate location row on the left-hand side, resulting in Figure 16.

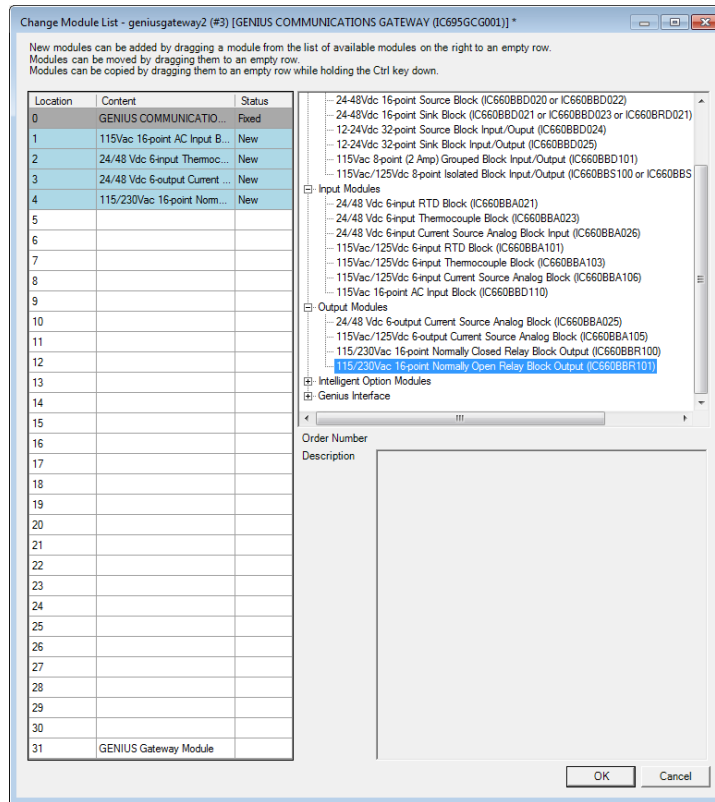

Figure 16: Populating the Genius IO Devices to be Controlled by the Genius Gateway

10. Special consideration needs to be given to the configuration of a Series 90-70 Remote I/O Scanner (BEM733) device on the Genius Bus, since this device is capable of controlling a rack filled with I/O modules, each of which needs to be suitably configured.
  - a. Add the BEM733 to the Genius Bus configuration as described above.
  - b. Drill down into the BEM733. A display of rack I/O will be presented (Figure 17):.

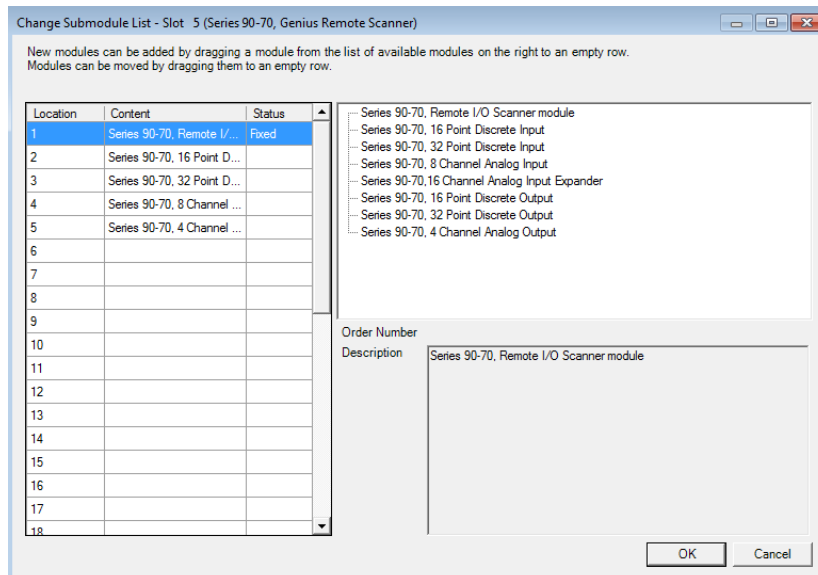

Figure 17: Populating Slots in S90-70 Rack Controlled by Remote I/O Scanner (BEM733)

- c. For each slot in the BEM733-controlled rack, select a generic I/O device (such as a 16-point discrete input module or a 4-channel analog output module) and attach that to its corresponding slot in the I/O rack. Note that actual part numbers have not been assigned for this procedure. If in doubt, check the data sheet related to each product number to determine the type of I/O it consumes (Analog or Discrete / Input or Output) and the number of I/O points it requires.
  - d. Once all BEM733-controlled rack slots have been suitably populated, save that portion of the configuration.
11. Once all the Genius Devices have been “populated” onto the Genius Bus topology as shown in Figure 16, click the **OK** button to save that portion of the configuration.
  12. Note that the I/O addresses associated with each Genius Device will have been provided with default assignments by Machine Edition. Double-click on each Genius device to examine its properties, and change the I/O assignments where needed. In retrofits, for example, it will likely be crucial to keep the same I/O assignments from the earlier implementation so that the controller logic can operate with the same I/O allocations as before. For each “location” on the Genius Bus, keep a note of the assigned I/O addresses.
  13. In Machine Edition, store the Hardware Configuration to the RX3i CPU, which also stores the GCG001 configuration data to the PNC001.

The following screenshot shows a completed configuration such as discussed above:

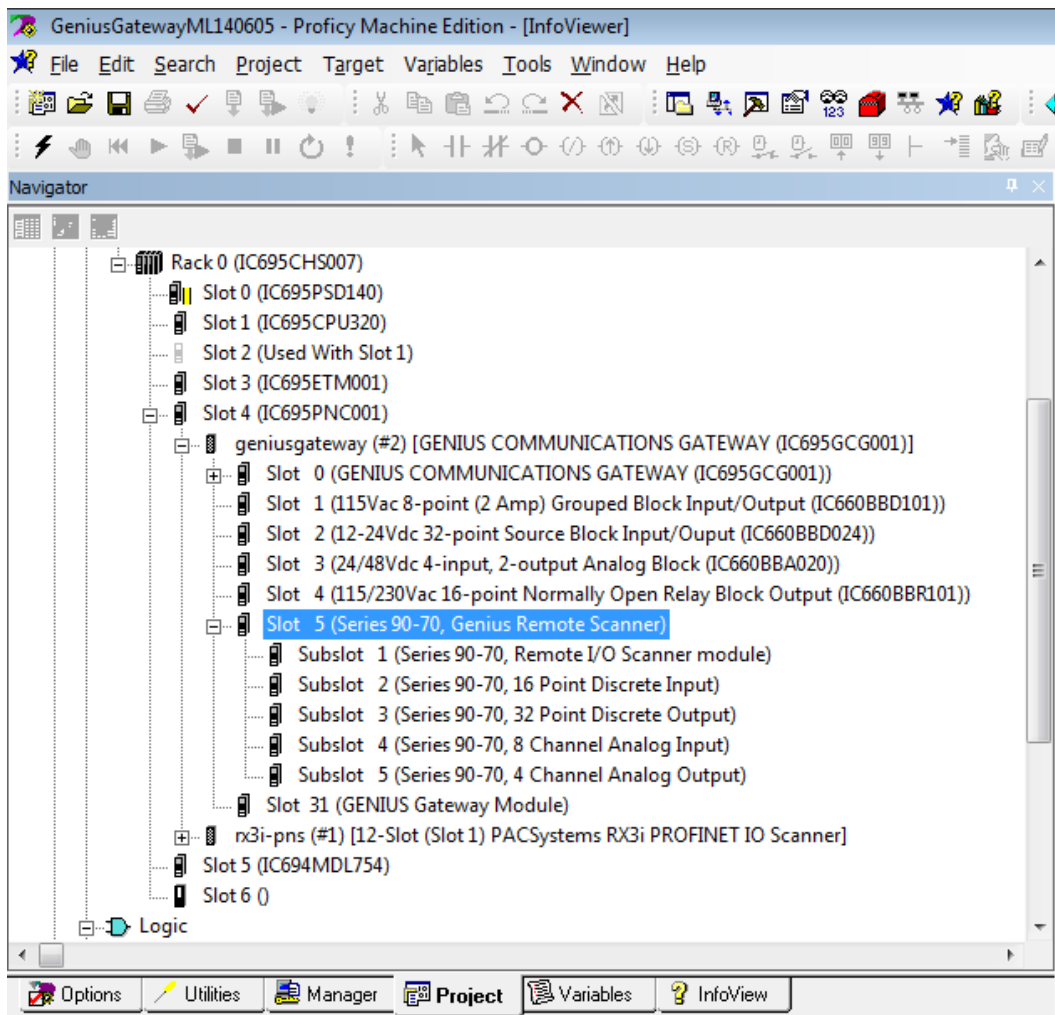

Figure 18: Genius Gateway Configuration Example

## Chapter 4 *System Operation*

This chapter provides a System Overview and describes:

- Communications
- Redundancy
- I/O Scans
- Alarms

### 4.1 *System Overview*

#### 4.1.1 *Communications*

As shown in Figure 7, the Genius Gateway (GCG001) sits on a PROFINET network which is connected to a PROFINET Controller (PNC001, for instance). The PROFINET Controller is mounted in an RX3i rack. This aspect of the architecture allows the RX3i to interact with the GCG001.

The PROFINET network to which the GCG001 is connected operates at 100Mbps only. The Network Speed will be set through auto-negotiation if necessary. Details of PROFINET communications may be found in the *RX3i PROFINET Controller System Manual GFK-2571*.

The GCG001 is also connected to a Genius Bus. It takes the place of a traditional Genius Bus Controller, meaning it is capable of communicating with up to 31 other Genius Devices. It is connected via its Genius Bus A terminal strip. Genius Bus B is inactive and should not be wired.

The Genius Bus operates as a Local Area Network (LAN) using twisted pair wiring. The wiring is daisy-chained via the terminal strips on each device, as shown in Figure 10. The Genius LAN will not be disrupted if power is lost on one its networked devices, since the wiring passes through each device without requiring any active electronics to be present. The LAN cabling must be terminated at one end of the cable run, using a resistor, the value of which matches the impedance of the cable used in the application. See Figure 11 for terminating the bus at the GCG001.

The Genius Bus is capable of operating at a number of different baud rates. All devices on the bus must operate at the same agreed baud rate. The GCG001 supports either 153.6 kBaud Standard or 153.6 kBaud Extended. It does not support lower baud rates. For further details see the *Genius I/O System and Communications User's Manual - GEK-90486*. The default baud rate of the GCG001, when shipped from the factory is 153.6 kBaud. This may be changed via the Machine Edition configuration software.

In the event the baud rate needs to be changed, the following sequence is recommended:

1. Disconnect the GCG001 module from the Genius bus.
2. Change the baud rate to the new value on all Genius devices connected to that bus.
3. Cycle power to all Genius devices on which the baud rate has just been changed.
4. Use the HHM to verify the baud rate was successfully changed on each device.
5. Retry the above steps on any devices that failed to switch over to the new baud rate.
6. Using Machine Edition, configure the GCG001 module to operate at the new baud rate.
7. Reconnect the GCG001 to the Genius bus.
8. Note that the HHM will not work reliably on a mixed baud rate bus. Connect the HHM directly to any device under these circumstances and disconnect that device from the Genius bus temporarily. The baud rate of the HHM can be altered (via the HHM keyboard) to match the configured baud rate of the device (which may be unknown). Once both the HHM and target device are set to the same baud rate, the HHM can command the target device to change to a new baud rate, which will take effect upon power cycling the device. Remember to then change the baud rate of the HHM to the new baud rate.

## 4.1.2 Redundancy

### Genius Hot Standby and Duplex Redundancy

Genius supports a number of different forms of redundancy, as described in the *Genius I/O System and Communications User's Manual - GEK-90486-1*. Only Genius Hot Standby and Duplex type redundancy (see GEK-90486-1 Chapter 8) is supported by the Genius Gateway (GCG001).

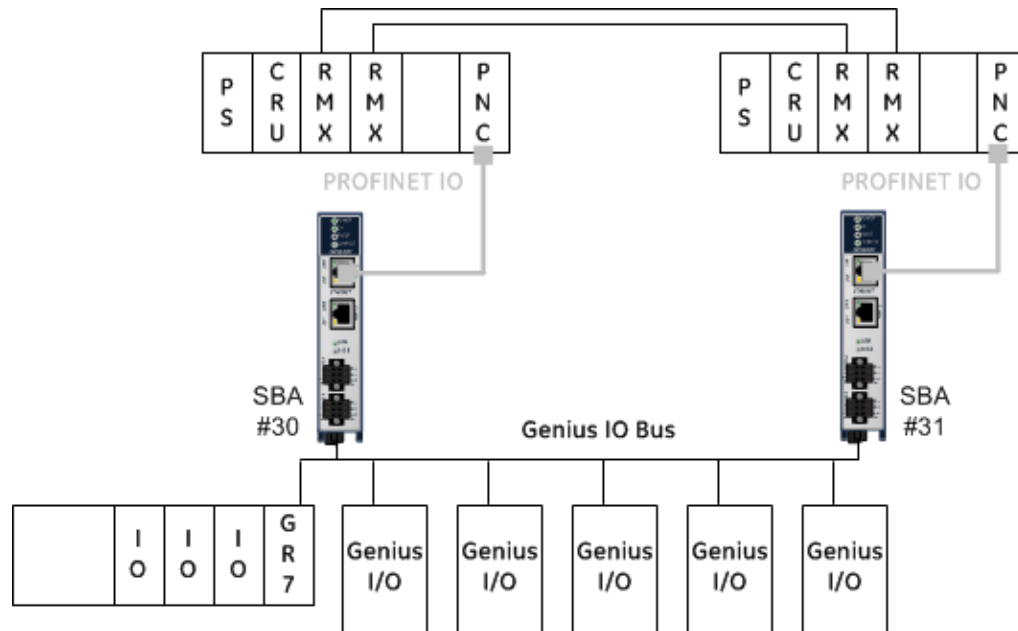

Figure 19: Genius Hot Standby Redundancy

To support either Genius Hot Standby or Duplex type redundancy, two GCG001 modules are present on the same physical Genius Bus, one at SBA #31 and the other at SBA #30, as shown in Figure 19. This architecture is designed to withstand the loss of one GCG001 and the loss of the PLC to which it is attached. The two GCG001 modules involved should therefore be powered via independent 24Vdc power supplies. Alternately, a Genius Bus Controller may be used at SBA #30 or #31.

In Genius Hot Standby, the I/O Blocks (both Analog and Digital) report all inputs to both SBA#30 and #31, but use output data from SBA#30 only whenever SBA#31 becomes unavailable. Rack I/O controlled by the GR7 also behaves in this way.

In Genius Duplex Redundancy, Discrete Output Blocks vote on the output data received from both SBA #30 and #31. A configuration parameter "Duplex Default State" must be configured for each output point. This parameter determines how the output will behave in the event the commanded output states received from SBA#30 and SBA#31 disagree. See GEK-90486-1 Chapter 8 for details. Whenever one of the controlling devices at SBA#30 or SBA#31 becomes unavailable, the output will be controlled by the remaining device. Discrete outputs in the rack I/O controlled by the GR7 also behave in this way.

Note that although the GCG001 provides two Genius Bus terminals and an LED marked "Bus B", these are not functional. The GCG001 does not support Genius Dual Bus Redundancy.

## Ethernet Media Redundancy Protocol

PROFINET also supports redundancy in the form of Ethernet Media Redundancy Protocol (MRP). As shown in Figure 20, this form of redundancy is designed to permit all devices on the network to continue to communicate even though the network cable has been compromised at one point. For details, see the *RX3i PROFINET Controller System Manual GFK-2571*.

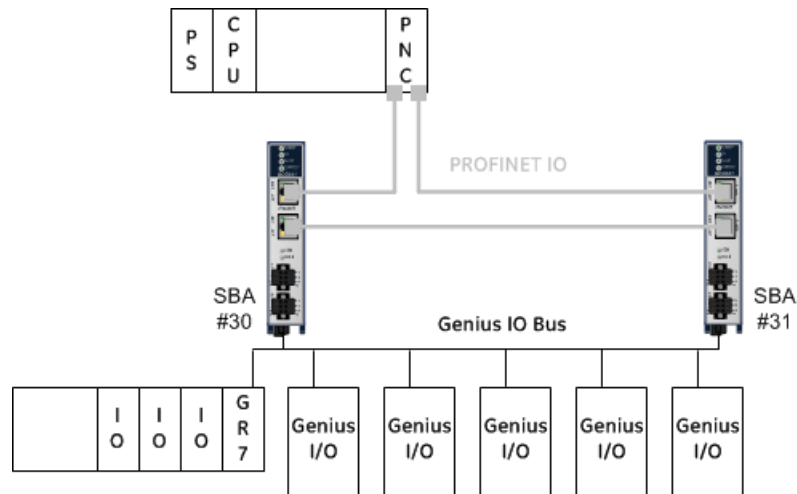

Figure 20: PROFINET Media Redundancy

### 4.1.3 I/O Scans

As shown in Figure 7, there are a number of I/O Scans that effect how the input and output devices on the Genius bus exchange data with the RSX3i PLC.

The RX3i scan reads input data from all the devices connected to it and active in its configuration. It uses this input data to solve the control logic supplied for the application. At the conclusion of the logic execution, the output data is ready for distribution and the output portion of the RX3i scan takes place.

The PNC001 PROFINET Controller operates on its own cycle, receiving input data for all devices connected to it, including the GCG001 Genius Gateway. It passes the input data to the RX3i during the RX3i input scan. When the RX3i performs its output scan, the output data configured to the PNC001 is transmitted by the PNC001 to the output devices on its network, including the GCG001 Genius Gateway.

The GCG001 also operates on its own scan cycle. As the Genius bus token passes from one SBA to the next, each device on the Genius Bus takes its turn to transmit its input data to the GCG001, which then makes that input data available to the PNC001. The GCG001 also consumes all the output data produced by the PNC001 and broadcasts that data to all the output devices on the Genius bus whenever it receives the Genius Bus token.

All of the I/O scans described above are asynchronous and may vary depending on the path through the RX3i logic, traffic on the PROFINET and traffic on the Genius Bus. Should I/O update rates be a concern for the application, it would be prudent to perform a worst-case analysis of the interacting scan cycles.

### 4.1.4 Alarms

Whenever an alarm condition occurs on a Genius Device, a background message (datagram) is transmitted from the device to the GCG001. This transmission occurs while the alarmed device has the Genius Bus token. Upon reception, the GCG001 formulates an Alarm message to be passed to the PNC001, which in turn passes it to the RX3i CPU. The RX3i takes appropriate action and notifies the operator per the logic in the application.

Alarms may be cleared programmatically using either the Clear Circuit Fault COMMREQ (see Figure 25) or the Clear All Circuit Fault COMMREQ, or via the Genius Hand-Held Monitor (HHM). Note that whenever the HHM is used to clear a circuit fault, the GCG001 will not be aware of this condition, thus will not have cleared the corresponding fault. Under these conditions, the "Diagnosis Disappears" Fault will not have been logged and any subsequent fault from the same point will not be reported to the I/O Fault Table. Be sure to follow up any HHM clearing of faults with a COMMREQ to clear the same fault(s) in order to eliminate the discrepancy described here.

Typically, the field problem needs to be investigated and resolved before the alarm can be successfully cleared. For the alarm to be cleared, the alarm condition must no longer be present and the Genius device must receive a suitable background message instructing it to clear the alarm notification. If the alarm condition is absent, the Genius device will cease to exhibit the alarm indication (LEDs will operate normally again). If the alarm condition is still present, a new alarm cycle will be initiated. See Sections 6.4.5, 6.4.6 and 6.4.4 for related COMMREQ or Data\_Init\_Comm instructions. Refer to GEK-90486-1, *Genius I/O System and Communications User's Manual*, for further details.

As mentioned in Section 1.8, the behaviour of the input references associated with a Genius Device that has indicated a fault, and which is interfaced to the CPU via the GCG001, is to cause all inputs to either hold last state or to default to a known state (per GCG001 configuration parameters). If this behaviour is problematic for your application, you can disable fault reporting at the block, using the Genius Hand-Held Monitor (HHM) – see "Report Faults" in GEK-90486-2. The downside is that your application will no longer be able to automatically sense faults at the corresponding Genius Device. The LEDs on the Genius Device will continue to indicate Fault conditions; however no datagram will be issued for each fault occurrence. An intermediate solution is to periodically query each such device with a "Read Diagnostics" datagram (Section 6.4.4) and parse the response in order to detect faulted circuits.

# Chapter 5 *Diagnostics*

This chapter describes:

- Status Bits
  - Genius Status Bits for Genius Gateway
  - PROFINET Status Bits for Genius Gateway
- Module LED Indicators
- Power-up
  - Module Restart
  - Problems During Power-up and Reset
  - Transitioning from Firmware Update Mode to Normal Operating Mode

## 5.1 Status Data

The GCG001 produces a total of 64 bits (8 bytes) to supply status information to the controlling PROFINET Controller. When ultimately controlled by an RX3i PLC, these reference bits consume a total of 64 reference address bits in %I memory. The 64 bits consist of

- 32 bits related to the operation of the GCG001 itself referred to in PME as “Gateway Status Data” and
- 32 bits related to the operation of the Genius bus which it controls – referred to as “Genius Status Data” in PME.

Each bank of 32 bits may be assigned a different set of Input reference addresses in RX3i memory.

For each bank of 32 status bits, a default beginning reference (the next available %I) for the status bits is automatically assigned by Proficy Machine Edition (PME). These assignments may be changed by clicking on the GCG001 and keying in different %I references.

### 5.1.1 PROFINET Status Data

For the Genius Gateway GCG001, the thirty-two bits in the PROFINET Status Data are organized as follows, beginning at the first %I status reference assigned to this bank of 32:

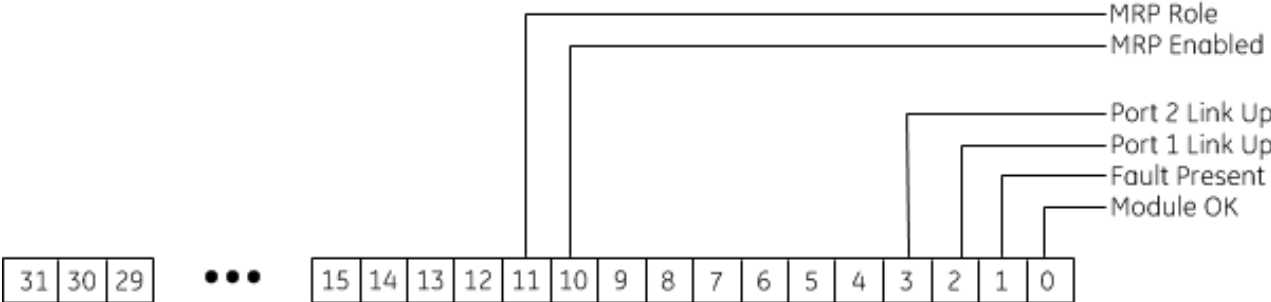

Figure 21: Gateway Status Data



Bit#	Name	Bit Condition	Meaning of Status Bit
0	Module OK	OFF	The GCG001 module is powering up or has failed.
		ON	Indicates the GCG001 module is functioning properly.
1	Fault Present	OFF	No GCG001 diagnosis data available; FAULT LED is Off.
		ON	GCG001 diagnosis data is available; FAULT LED is On.
2	Port1 Link Up	OFF	Port is not connected to a properly configured device, or port is experiencing communications errors.
		ON	Port is connected to another device and is communicating.
3	Port2 Link Up	OFF	Port is not connected to a properly configured device, or port is experiencing communications errors.
		ON	Port is connected to another device and is communicating.
4-9	Reserved	OFF	Always off.
		ON	N/A
10	MRP Enabled	OFF	MRP is not enabled.
		ON	MRP is enabled.
11	MRP Role	OFF	Indicates that the GCG001 is an MRP Client (if MRP is enabled), or that MRP is not enabled.
		ON	Indicates role is that of an MRP Manager - this is not a possible role for the GCG001.
12-31	Reserved	OFF	Always off.
		ON	N/A

### 5.1.2 Genius Status Data

For the Genius Status Data, status bits are arranged in ascending order of the Genius Serial Bus Addresses (SBAs), beginning at the first %I status reference assigned to this bank of 32.

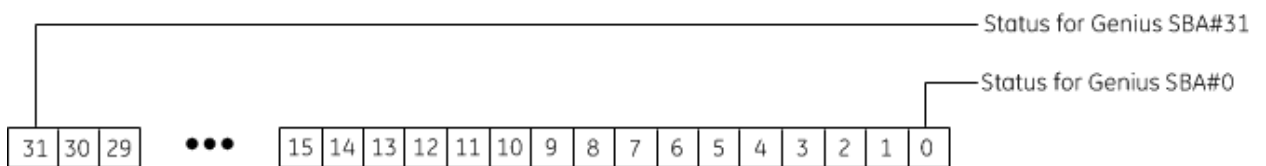

Figure 22: Genius Status Data

Bit Condition	Meaning of Status Bit
OFF	No device present at SBA, or device not configured, or device not communicating.
ON	Device present, configured and communicating at corresponding SBA.

## 5.2 Module LED Indicators

See Section 2.4.4 above for a description of LED indications.

## 5.3 Power-Up

The GCG001 powers up whenever 24Vdc power is properly applied via the connector shown in Figure 9. During the power-up sequence, the GCG001 module runs diagnostics and initializes its hardware components. When the necessary hardware components have been initialized and tested, the module transitions to either normal operation or, if the firmware load pushbutton is being depressed (see Figure 8), to the firmware update mode.

The firmware update mode is described in Section 2.7.

As the GCG001 transitions to normal operation, it attempts to establish communications with the PROFINET Controller. Until communications have been established, normal operation cannot begin.

Once the PROFINET Controller matches the configured PROFINET Device Name that of the GCG001, PROFINET communications will begin. Any faults detected by the GCG001 prior to this event will then be uploaded to the PROFINET Controller.

Normal system operation will begin once the RX3i is in RUN mode, PROFINET communications are up and running and Genius Bus operations are also up and running.

### 5.3.1 Problems during Power-up

Certain conditions can prevent the module from powering up and becoming operational or entering firmware update mode:

<i>Problem</i>	<i>Indication</i>	<i>Action</i>
Hardware failure	All Indicator LEDs off. Module unresponsive.	Contact Technical Support to arrange for repair and replacement
Invalid boot image		
Invalid firmware image	Power LED is ON but OK LED is off or Power LED alternates Green & Amber	Perform firmware update

### 5.3.2 Transitioning from Firmware Update Mode to Operational Mode

As described in Section 2.7, the firmware load pushbutton (see Figure 8) must be depressed during power-up in order to invoke the GCG001 firmware load mode. Whenever the GCG001 is powered up without this button being depressed, normal operating mode will commence following power-up testing and initialization. Cycling power transitions the module from one mode to the other, depending on the condition of the pushbutton.

## 5.4 Module Faults in the RX3i I/O Fault Tables

Module faults from the Genius Devices downstream from the GCG001 Genius Gateway are passed to the PROFINET Controller and then to the PLC, where they are visible in the PLC's I/O Fault Table. For details on the operation of the RX3i Fault Table, see GFK-2222 Chapter 14.

The I/O fault table displays I/O faults such as circuit faults, address conflicts, forced circuits, I/O module addition/loss faults and I/O bus faults. The contents of the I/O Fault Table entry are as follows:

Entry	Description
Location	Identifies the location of the fault by bus and serial bus address (SBA).
CIRC No.	When applicable, identifies the specific faulted I/O point on the module (enumerated 1-8 for an 8-point I/O block, for instance).
Variable Name	If the fault is associated with a point that is mapped to an I/O variable, and the variable is set to publish (either internal or external), the I/O fault table displays the variable name. Unpublished I/O variables will not be displayed in this field.
Ref. Address	If the fault is on a point that is mapped to a reference address, this field identifies the I/O memory type and location (offset) that corresponds to the point experiencing the fault. When a Genius device fault or local analog module fault occurs, the reference address refers to the first point on the block where the fault occurred.
Fault Category	Specifies a general classification of the fault.
Fault Type	Consists of subcategories under certain fault categories. Set to zero when not applicable to the category. See Section 5.4.1 below.
Date/Time	The date and time the fault was recorded by the CPU based on the RX3i CPU clock.
Details	To view detailed information, click the fault entry.

**Note:** The Reference Address field displays 16-bits and %W memory has a 32-bit range. Addresses in %W are displayed correctly for offsets in the 16-bit range ( $\leq 65,535$ ). For %W offsets greater than 16-bits, the I/O Fault Table displays a blank reference address.

As mentioned in Section 5.1, the GCG001 consumes two banks of 32 bits in %I as status bits (a) for the GCG001 itself and (b) for the Genius bus devices it controls. These are not to be confused with the entries in the I/O Fault Table.

### 5.4.1 Fault Types Reported to the RX3i Controller I/O Fault Table

When imported into the Rx3i I/O Fault Table, the following Error Codes are displayed without explanation. The following table is provided to assist in decoding the displayed error codes.

<b>Fault Type</b>	<b>Description</b>
257	Internal Circuit fault
258	Shared RAM fault
259	Electronics Assembly EEPROM fault
260	Communication interface fault
261	Terminal Strip EEPROM fault or NVRAM fault
262	EEPROM fault
263	Private RAM fault
264	Processor fault
273	Failed Switch
274	Open Input / Over-Temperature
275	No Load Present
276	Overload
277	Short Circuit
278	Loss of I/O Power
289	Feedback Error
290	Output channel over-range
291	Output channel under-range
292	Input channel open wire
293	Input channel over-range
294	Input channel under-range
295	Input channel high alarm
296	Input channel low alarm
305	Input channel shorted
306	Internal channel fault
307	Input channel wiring error
308	Input channel open wire
309	Input channel over-range
310	Input channel under-range
311	Input channel high alarm
312	Input channel low alarm
400	unknown Error-Type
1026	Invalid Genius Gateway module configuration
1027	Invalid Genius Gateway module configuration
1028	Extra Genius device
1029	Configuration mismatch in a S90-70 Remote Scanner Rack

Controller Date/Time: 01-07-2000 20:43:51  
 Last Cleared: 01-07-2000 20:26:42

### Fault Table Viewer

Status
Online

I/O Fault Table (Displaying 2 of 2 faults, 0 Overflowed)																																																
Loc	CIRC No.	Variable Name	Ref. Address	Fault Category	Fault Type	Date/Time																																										
0.7.D25.r0.s1.ss1	0		%QI 00041	Channel Diagnosis Disappears	Manufacturer specific (275)	01-07-2000 20:31:23																																										
<table border="1"> <tr> <td>I/O Bus</td> <td>Bus Address</td> <td>Point Address</td> <td>Group</td> <td>Action</td> <td>Category</td> <td>Fault Type</td> </tr> <tr> <td>1</td> <td>25</td> <td>0</td> <td>28</td> <td>1:Informational</td> <td>41</td> <td>275</td> </tr> <tr> <td>Fault Extra Data</td> <td colspan="6">00 04 50 00 01 13 00 00 00 00 00 00 00 00 00 00 00 00</td> </tr> <tr> <td>Fault Description</td> <td colspan="6"></td> </tr> <tr> <td>Lan Name:</td> <td colspan="6">LAN01</td> </tr> <tr> <td>Device Name:</td> <td colspan="6">geniusgateway8</td> </tr> </table>							I/O Bus	Bus Address	Point Address	Group	Action	Category	Fault Type	1	25	0	28	1:Informational	41	275	Fault Extra Data	00 04 50 00 01 13 00 00 00 00 00 00 00 00 00 00 00 00						Fault Description							Lan Name:	LAN01						Device Name:	geniusgateway8					
I/O Bus	Bus Address	Point Address	Group	Action	Category	Fault Type																																										
1	25	0	28	1:Informational	41	275																																										
Fault Extra Data	00 04 50 00 01 13 00 00 00 00 00 00 00 00 00 00 00 00																																															
Fault Description																																																
Lan Name:	LAN01																																															
Device Name:	geniusgateway8																																															
0.7.D25.r0.s1.ss1	0		%QI 00041	Channel Diagnosis Appears	Manufacturer specific (275)	01-07-2000 20:31:17																																										
<table border="1"> <tr> <td>I/O Bus</td> <td>Bus Address</td> <td>Point Address</td> <td>Group</td> <td>Action</td> <td>Category</td> <td>Fault Type</td> </tr> <tr> <td>1</td> <td>25</td> <td>0</td> <td>28</td> <td>2:Diagnostic</td> <td>40</td> <td>275</td> </tr> <tr> <td>Fault Extra Data</td> <td colspan="6">a8 03 48 00 01 13 00 00 00 00 00 00 00 00 00 00 00 00</td> </tr> <tr> <td>Fault Description</td> <td colspan="6"></td> </tr> <tr> <td>Lan Name:</td> <td colspan="6">LAN01</td> </tr> <tr> <td>Device Name:</td> <td colspan="6">geniusgateway8</td> </tr> </table>							I/O Bus	Bus Address	Point Address	Group	Action	Category	Fault Type	1	25	0	28	2:Diagnostic	40	275	Fault Extra Data	a8 03 48 00 01 13 00 00 00 00 00 00 00 00 00 00 00 00						Fault Description							Lan Name:	LAN01						Device Name:	geniusgateway8					
I/O Bus	Bus Address	Point Address	Group	Action	Category	Fault Type																																										
1	25	0	28	2:Diagnostic	40	275																																										
Fault Extra Data	a8 03 48 00 01 13 00 00 00 00 00 00 00 00 00 00 00 00																																															
Fault Description																																																
Lan Name:	LAN01																																															
Device Name:	geniusgateway8																																															

Figure 23: Genius Discrete Block "No Load Present" Fault Display (example)

Table Entry	Explanation	Value	Interpretation
Loc	Location of Fault	0.7.D25.r0.s1.ss1	Rack 0 Slot 7 = location of PNC D25 = Device Number of GCG r0 = SBA of faulted Genius device s1, ss1 not used
Circ No.	Genius Device Circuit #	0	First point on Genius device is faulted
Variable Name	Alternate to Ref Address		Will display if variable name has been assigned
Ref. Address	PLC Reference Address	%QI 00041	Point 41 in %QI table is referenced
Fault Category	Coded Fault Category	Channel Diagnosis Appears/Disappears	"Appears" when fault first detected at PLC. "Disappears" when fault has been resolved.
Fault Type	Coded Fault Type	Manufacturer specific	See table of Fault Types (page 37).
Date/Time	Date/Time		Date/Time fault is registered by PLC.

Controller Date/Time: 01-01-2000 01:58:51  
 Last Cleared: 01-01-2000 01:55:01

### Fault Table Viewer

Status
Online

I/O Fault Table (Displaying 2 of 2 faults, 0 Overflowed)																																														
Loc	CIRC No.	Variable Name	Ref. Address	Fault Category	Fault Type	Date/Time																																								
0.7.D27.r0.s3. ss1	0		%AQ 00101	Channel Diagnosis Disappears	Manufacturer specific (290)	01-01-2000 01:56:11																																								
				<table border="1"> <thead> <tr> <th>I/O Bus</th> <th>Bus Address</th> <th>Point Address</th> <th>Group</th> <th>Action</th> <th>Category</th> <th>Fault Type</th> </tr> </thead> <tbody> <tr> <td style="text-align: center;">1</td> <td style="text-align: center;">27</td> <td style="text-align: center;">0</td> <td style="text-align: center;">28</td> <td style="text-align: center;">1:Informational</td> <td style="text-align: center;">41</td> <td style="text-align: center;">290</td> </tr> <tr> <td colspan="7">Fault Extra Data: 00 0a 52 00 01 22 00 00 00 00 00 00 00 00 00 00 00 00 00 00</td> </tr> <tr> <td colspan="7">Fault Description:</td> </tr> <tr> <td colspan="7">Lan Name: LAN01</td> </tr> <tr> <td colspan="7">Device Name: geniusgateway9</td> </tr> </tbody> </table>	I/O Bus	Bus Address	Point Address	Group	Action	Category	Fault Type	1	27	0	28	1:Informational	41	290	Fault Extra Data: 00 0a 52 00 01 22 00 00 00 00 00 00 00 00 00 00 00 00 00 00							Fault Description:							Lan Name: LAN01							Device Name: geniusgateway9						
I/O Bus	Bus Address	Point Address	Group	Action	Category	Fault Type																																								
1	27	0	28	1:Informational	41	290																																								
Fault Extra Data: 00 0a 52 00 01 22 00 00 00 00 00 00 00 00 00 00 00 00 00 00																																														
Fault Description:																																														
Lan Name: LAN01																																														
Device Name: geniusgateway9																																														
0.7.D27.r0.s3. ss1	0		%AQ 00101	Channel Diagnosis Appears	Manufacturer specific (290)	01-01-2000 01:56:05																																								
				<table border="1"> <thead> <tr> <th>I/O Bus</th> <th>Bus Address</th> <th>Point Address</th> <th>Group</th> <th>Action</th> <th>Category</th> <th>Fault Type</th> </tr> </thead> <tbody> <tr> <td style="text-align: center;">1</td> <td style="text-align: center;">27</td> <td style="text-align: center;">0</td> <td style="text-align: center;">28</td> <td style="text-align: center;">2:Diagnostic</td> <td style="text-align: center;">40</td> <td style="text-align: center;">290</td> </tr> <tr> <td colspan="7">Fault Extra Data: 00 09 4a 00 01 22 00 00 00 00 00 00 00 00 00 00 00 00 00 01</td> </tr> <tr> <td colspan="7">Fault Description:</td> </tr> <tr> <td colspan="7">Lan Name: LAN01</td> </tr> <tr> <td colspan="7">Device Name: geniusgateway9</td> </tr> </tbody> </table>	I/O Bus	Bus Address	Point Address	Group	Action	Category	Fault Type	1	27	0	28	2:Diagnostic	40	290	Fault Extra Data: 00 09 4a 00 01 22 00 00 00 00 00 00 00 00 00 00 00 00 00 01							Fault Description:							Lan Name: LAN01							Device Name: geniusgateway9						
I/O Bus	Bus Address	Point Address	Group	Action	Category	Fault Type																																								
1	27	0	28	2:Diagnostic	40	290																																								
Fault Extra Data: 00 09 4a 00 01 22 00 00 00 00 00 00 00 00 00 00 00 00 00 01																																														
Fault Description:																																														
Lan Name: LAN01																																														
Device Name: geniusgateway9																																														

Figure 24: Genius Analog Block "Over Range" Fault Display (example)

### 5.4.2 Clearing the RX3i Fault Tables

Clearing the RX3i CPU's I/O fault tables has no effect on the GCG001 or on the Genius Devices downstream from it. This action merely clears the I/O Fault Table temporarily. Use the Genius HHM or COMREQs in the PLC program to exercise I/O points that had previously exhibited faults, and where the underlying field fault condition has already been corrected.



## Chapter 6 *COMMREQ/Data\_Init\_Comm Programming*

This chapter explains how to use Communication Requests (COMMREQs) to perform specific tasks with Genius devices that are attached to a Gateway's Genius bus. COMMREQs are instructions in the RX3i ladder logic (see example in Figure 25). When a COMMREQ is executed in ladder logic, communications traffic is directed to the indicated PROFINET Controller module (IC695PNC001). The PROFINET Controller then communicates with the Genius Gateway over PROFINET. The Genius Gateway subsequently sends the corresponding background datagram to the Genius block Serial Bus Address (SBA) specified in the COMMREQ. Status, and optionally some data, is returned from the Genius Block via the Genius Gateway to the PROFINET Controller and then to the reference memory in the CPU module.

Data\_Init\_Comm is a ladder logic instruction that can be used to help set up a COMMREQ. It is a more user-friendly instruction from the programmer's perspective. It performs the same functions as are described in this Chapter. An example is shown at Figure 26.

For additional information about Genius datagrams, see the *Genius I/O System and Communications Manual (GEK-90486-1)*, which describes Genius Datagrams in detail.

### 6.1 *COMMREQs and Passwords*

Level 1 and 2 controller passwords, which prevent write access, cannot be used in applications that include COMMREQs. COMMREQs require write access to return their completion status and requested data.

### 6.2 *Programming for a COMMREQ Communication Request*

In order to communicate via a COMMREQ with a Genius device attached via a Genius Gateway module, the application program should perform the following actions.

- 1) **Supply the content of the COMMREQ communication.** Ladder logic Block Moves, Data\_Init\_Comm, or similar program instructions can be used to place the required information into CPU memory. This content is called the Command Block.



- 2) **Clear status block.** The program should set the status block to all zeroes (see programming example Figure 25). Establishing this initial condition allows the program to differentiate between the result of an earlier command and the currently-executing COMMREQ command.



- 3) **Use a COMMREQ instruction to perform the intended function.**

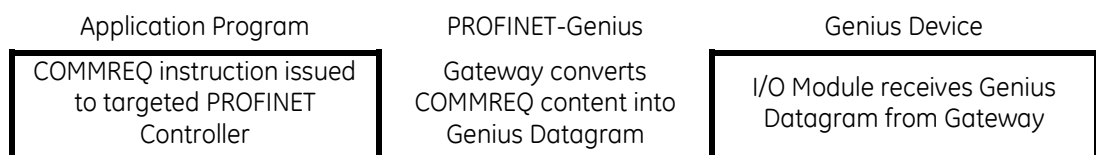



- 4) **Check the status of the initiated COMMREQ task.** COMMREQs should be executed sequentially. The application program should check that the status of the previous COMMREQ to the targeted PROFINET Controller is complete before sending it another one. Failure to do this may result in improper operation of the PROFINET Controller.

### 6.3 COMMREQ Command Block Format

The first step in programming communications requests is to set up the contents of the COMMREQ instruction. This can be done using Block Moves or similar program instructions, as shown later in this chapter.



Data is placed in adjacent locations in CPU memory to form a Command Block, per the format shown below:

Location	Data Field	Value
address	"Data Block" Length	
address + 1	Wait/No Wait Flag	Always 0
address + 2	Status Pointer Memory Type	
address + 3	Status Pointer Offset	
address + 4	Idle Timeout Value (ms)	Always 0
address + 5	Max. Communication Time (ms)	Always 0
address + 6 to address + 78	Data Block	

The length of the Command Block depends on the type of COMMREQ being sent. Seventy words is the maximum and is used only for a COMMREQ that transfers a 128-byte datagram. Most Command Blocks are much shorter. The table in Section 6.3.3 gives an overview of the contents of each type of COMMREQ that may be sent to a PROFINET Controller for transfer to a Genius Gateway.

### 6.3.1 COMMREQ Command Block Contents

Each field in the Command Block is described below:

Data Field	Explanation																					
"Data Block" Length	This is the amount of data from <b>[address + 6]</b> to the end of the Command Block. Each type of COMMREQ command has a unique Data Block. See Section 6.4.																					
Wait/No Wait Flag	This must be set to zero, indicating <b>No Wait</b> .																					
	The <b>Status Pointer Memory Type</b> and <b>Status Pointer Offset</b> defined below combine to identify the <b>location in CPU Memory of the Status Block</b> associated with this COMMREQ. The Status Block is the location to which the COMMREQ will return its status. If one of the bit-oriented memories (%I or %Q) is used as the Status Block location, those bits can be monitored by the PLC program.																					
Status Pointer Memory Type	The Memory Type used is defined by <b>[address + 2]</b> , as follows: <table border="1"> <thead> <tr> <th>Memory Type</th> <th>Description</th> <th>Required Entry</th> </tr> </thead> <tbody> <tr> <td>%I</td> <td>discrete input table</td> <td>70</td> </tr> <tr> <td>%Q</td> <td>discrete output table</td> <td>72</td> </tr> <tr> <td>%R</td> <td>register memory</td> <td>8</td> </tr> <tr> <td>%AI</td> <td>analog input table</td> <td>10</td> </tr> <tr> <td>%AQ</td> <td>analog output table</td> <td>12</td> </tr> <tr> <td>%W</td> <td>Bulk Memory</td> <td>196</td> </tr> </tbody> </table>	Memory Type	Description	Required Entry	%I	discrete input table	70	%Q	discrete output table	72	%R	register memory	8	%AI	analog input table	10	%AQ	analog output table	12	%W	Bulk Memory	196
Memory Type	Description	Required Entry																				
%I	discrete input table	70																				
%Q	discrete output table	72																				
%R	register memory	8																				
%AI	analog input table	10																				
%AQ	analog output table	12																				
%W	Bulk Memory	196																				
Status Pointer Offset	The offset into the Memory Type (above) is defined by <b>[address + 3]</b> . Note that the offset is 0-based. For example, if the Status Block were located at %R099, memory type would be specified as 08 (for %R memory) and the offset would be entered as 98 so as to point to %R099. Note that if a bit-oriented memory (%I or %Q) is specified, a byte boundary must be used for the offset.																					
Idle Timeout Value (ms)	This field is not used for the No Wait mode of communication.																					
Max. Communication Time (ms)	This field is not used for the No Wait mode of communication.																					
Data Block	The Data Block contains the parameters of the command. Complete descriptions of all commands appear later in this chapter (see Section 6.4). <table border="1"> <thead> <tr> <th>Location</th> <th>Function</th> </tr> </thead> <tbody> <tr> <td>address + 6</td> <td>Command Number (see Section 6.3.2)</td> </tr> <tr> <td>address + 7</td> <td>PROFINET Device Number (1-255) of the targeted Genius Gateway.</td> </tr> <tr> <td>address + 8</td> <td>Targeted Genius Device Number (0-31). The serial bus address (SBA) of the Genius device connected to the targeted Genius Gateway.</td> </tr> <tr> <td>thru address + 78</td> <td>Parameters of the specific Command Number (see following sections in this chapter).</td> </tr> </tbody> </table>	Location	Function	address + 6	Command Number (see Section 6.3.2)	address + 7	PROFINET Device Number (1-255) of the targeted Genius Gateway.	address + 8	Targeted Genius Device Number (0-31). The serial bus address (SBA) of the Genius device connected to the targeted Genius Gateway.	thru address + 78	Parameters of the specific Command Number (see following sections in this chapter).											
Location	Function																					
address + 6	Command Number (see Section 6.3.2)																					
address + 7	PROFINET Device Number (1-255) of the targeted Genius Gateway.																					
address + 8	Targeted Genius Device Number (0-31). The serial bus address (SBA) of the Genius device connected to the targeted Genius Gateway.																					
thru address + 78	Parameters of the specific Command Number (see following sections in this chapter).																					

### 6.3.2 COMMREQ Commands Supported by the Genius Gateway (GCG001)

Command #	Function	Section
1	Pulse Test	6.4.1
2	Read Configuration	6.4.2
3	Write Configuration	6.4.3
4	Read Diagnostics	6.4.4
5	Clear Circuit Fault	6.4.5
6	Clear All Circuit Faults	6.4.6
7	Assign Monitor	6.4.7
11	Read Device <sup>1</sup>	6.4.8
12	Write Device <sup>1</sup>	6.4.9
19	Read Identification	6.4.10
20	Write Point <sup>1</sup>	6.4.11
21	Read Block I/O	6.4.12
22	Read Map	6.4.13
23	Write Map	6.4.14
24	Read Data	6.4.15
25	Write Data	6.4.16

<sup>1</sup> Note that while the GCG001 does support the indicated COMMREQs, the devices which respond to such COMMREQs are not currently supported by the GCG001.

### 6.3.3 COMMREQ Command Block Quick Reference

The table below summarizes all COMMREQs supported by the Genius Gateway. Beyond “Address+8”, please see the individual COMMREQ specification in Sections 6.4.1 thru 6.4.16.

COMMREQ	COMMREQ Content								
	Addr	Addr+1	Addr+2	Addr+3	Addr+4	Addr+5	Addr+6	Addr+7	Addr+8
	Length	Wait/ No Wait	Status Pointer Memory Type	Status Pointer Offset	Idle Timeout Value	Max. Comm Time	COMM REQ #	PROFINET Device Number	Genius Device Number
Pulse Test	3	0	see 6.3.1		0	0	1	1-255	0-31
Read Configuration	7	0	see 6.3.1		0	0	2	1-255	0-31
Write Configuration	4+n	0	see 6.3.1		0	0	3	1-255	0-31
Read Diagnostics	7	0	see 6.3.1		0	0	4	1-255	0-31
Clear Circuit Fault	4	0	see 6.3.1		0	0	5	1-255	0-31
Clear All Circuit Faults	3	0	see 6.3.1		0	0	6	1-255	0-31
Assign Monitor	4	0	see 6.3.1		0	0	7	1-255	0-31
Read Device	18	0	see 6.3.1		0	0	11	1-255	0-31
Write Device	14-78	0	see 6.3.1		0	0	12	1-255	0-31
Read Identification	7	0	see 6.3.1		0	0	19	1-255	0-31
Write Point	8	0	see 6.3.1		0	0	20	1-255	0-31
Read Block I/O	8	0	see 6.3.1		0	0	21	1-255	0-31
Read Map	7	0	see 6.3.1		0	0	22	1-255	0-31
Write Map	12	0	see 6.3.1		0	0	23	1-255	0-31
Read Data	9	0	see 6.3.1		0	0	24	1-255	0-31
Write Data	7	0	see 6.3.1		0	0	25	1-255	0-31

### 6.3.4 Mechanics of the COMMREQ Instruction

Once the content of the of the COMMREQ communication has been set up (in the COMMREQ Command Block, as described above) the application program will need to activate the corresponding COMMREQ instruction in order to initiate communications with the target Genius Device (via the interconnected PROFINET Controller and Genius Gateway).

This section describes the mechanisms employed by the PLC logic to initiate and monitor the COMMREQ instruction and its aftermath.

The COMMREQ instruction has four inputs and two outputs:

#### COMMREQ Inputs

COMMREQ Input	Description						
<b>(enable)</b>	Permissive logic that controls power flow to the COMMREQ function block.						
<b>IN</b>	The memory location of the Command Block containing the specific COMMREQ command information. The Command Block may be located in any word-oriented area of memory (%P, %L, %R, %AI, %AQ, or %W).						
<b>SYSID</b>	A two-byte hex value that gives the rack and slot location of the controlling PROFINET Controller. The rack number must be zero and occupies the more significant byte; the slot number in which the PROFINET Controller is located occupies the less significant byte. Example: <table border="1" style="margin-left: 20px;"> <thead> <tr> <th>Rack#</th> <th>Slot#</th> <th>Resulting SysID Hex Word Value</th> </tr> </thead> <tbody> <tr> <td>0</td> <td>4</td> <td>0004h</td> </tr> </tbody> </table>	Rack#	Slot#	Resulting SysID Hex Word Value	0	4	0004h
Rack#	Slot#	Resulting SysID Hex Word Value					
0	4	0004h					
<b>TASK</b>	The task is always "132" (decimal).						

Thus, the input specifies the conditions under which the COMMREQ is to be activated, and specifies which PROFINET Controller and which Genius Gateway are targeted in this activity.

#### COMMREQ Outputs

COMMREQ Output	Description
<b>OK</b>	Indicates correct execution of the COMMREQ.
<b>FT</b>	Indicates a fault condition in COMMREQ execution.

The behavior of the COMMREQ Outputs is shown in the following truth table. Note that the OK and FT outputs are never both true at the same time:

Enable	Error?	OK	FT
active	no	true	false
active	yes	false	true
not active	no execution	false	false

The COMMREQ passes power flow to its OK output unless:

- The specified module (in rack/slot) is not present.
- The specified task is not valid for the target device.
- The data length is zero.

If any fault intrinsic to the conduct of the COMMREQ occurs, power flow passes to the FT output instead.

If there are errors in the portion of the Command Block used specifically by the PROFINET Controller or Genius Gateway (for example, the Device Number entered is incorrect), these errors are reflected in the value returned in the Status Block location, not in the FT output.

### COMMREQ Status Block

Once a COMMREQ command is completed, the PROFINET Controller writes any resulting data into the area designated in the COMMREQ command and then sets the status to Complete (4). However, if an error occurred during processing of the command, the status will be set to one of the possible error values. Possible status values are listed below.

**Note:** Because COMMREQs require write access to return their status, level 1 and 2 Controller passwords, which prevent write access, cannot be used with COMMREQs. If an illegal memory type is specified, a fault will be generated.

If one of the bit-oriented memories (%I or %Q) is used as the status location, the designated bits can be monitored. These bits correspond to the binary values listed below. For example, if %I048 were selected as the beginning location, reference %I050 would be set to 1 each time the COMMREQ completed successfully (corresponding to a value of 04 Hex).

### Clearing the Status Block

COMMREQs to the target PROFINET Controller should be executed sequentially. Before sending a COMMREQ to the PROFINET Controller, the application program should check the status of any previous COMMREQ to that specific PROFINET Controller.



When the previous COMMREQ has completed, the user's PLC program should set the Status Block to zero. Establishing this initial condition allows the program to differentiate between the result of an earlier command and the currently-executing command.

### Contents of the Status Block

The Status Block consists of two words in PLC memory to which the PROFINET Controller returns the status of the COMMREQ.

The lower word is used for general information about the execution of the COMMREQ:

VALUE		DESCRIPTION
decimal (word)	binary (bit)	
0	00000000 00000000	Command has not been processed.
1	00000000 00000001	Command not accepted: target PROFINET Controller busy with previous request.
2	00000000 00000010	Command currently being processed, not yet completed.
4	00000000 00000100	Command completed successfully.
8	00000000 00001000	Command terminated due to a syntax error.
16	00000000 00010000	Command terminated due to a data error.
128	00000000 10000000	Command not supported.
4096	00010000 00000000	Command failed.
32769	00100000 00000001	Unknown Task ID rejected by the PNC COMMREQ Manager.
32770	00100000 00000010	PNC COMMREQ Manager got an internal error while dispatching the request.

The upper word of the status location provides additional status information.

VALUE decimal (word)	VALUE Hex (word)	DESCRIPTION
0	0	Command has not been processed.
1	1	Non-specific command failure.
2	2	Null or invalid command block.
3	3	Unknown Task ID detected. Task ID should be 132 for Gateway COMMREQs, or 131 for generic PROFINET acyclic requests.
4	4	Command completed successfully.
5	5	Incorrect command block length.
10	0x0A	Unknown command number.
11	0x0B	Invalid PROFINET device number. Number should be in the range 1 through MAX_PROFINET_IO_DEVICE_CONNECTIONS (model-specific definition).
12	0x0C	PROFINET device is 'undeclared'. The PROFINET device specified in the command block is not known to the PNC as currently configured.
13	0x0D	PROFINET API value is out of range. The value should be 0 or 1 (always 0 for Gateway requests).
14	0x0E	PROFINET slot value is out of range. The value should be in the range 0 through 31 (Gateway requests normally use 31, except when using read index 0x0203).
15	0x0F	PROFINET subslot value is out of range. Gateway requests always use subslot 1. Generic acyclic requests test for a subslot value in range 1 through 32784.
16	0x10	Invalid transfer length specified. Value is either too large, or zero.
17	0x11	PROFINET stack interface failure; read_req call failed at invocation site.
18	0x12	Error returned from PROFINET stack; a generic acyclic request issued a read_req call that produced a negative confirmation callback.
19	0x13	PROFINET stack interface failure; write_req call failed at invocation site.
20	0x14	Error returned from PROFINET stack; a generic acyclic request issued a write_req call that produced a negative confirmation callback.
21	0x15	Invalid Genius device number. Value should be in range 0 through 31.
22	0x16	Invalid circuit number. Value should be in range 1 through 32.
23	0x17	Error returned from PROFINET stack; a Gateway request issued a write_req call that produced a negative confirmation callback.
24	0x18	Error returned from PROFINET stack; a Gateway request issued a read_req call that produced a negative confirmation callback.
25	0x19	Last write request to the Gateway timed out or had an error. When Gateway status was checked (via read index 0x0200), the returned value was 2.
26	0x1A	Last write request to the Gateway caused a "stuck busy" result. Gateway status checks (via read index 0x0200) have returned a value of 1 for more than 300 msec.
27	0x1B	Gateway status check (via read index 0x0200) returned an invalid value (not 0, 1, or 2).
28	0x1C	Error returned from PROFINET stack; an attempt to retrieve a Genius Reply from the Gateway (via read index 0x0201) produced a negative confirmation callback.
29	0x1D	The message status byte associated with a Genius Reply is not 0, indicating a problem.
30	0x1E	A Genius Reply does not have the expected length.
31	0x1F	A Write Configuration COMMREQ specified a configuration data length that does not match the required configuration length for the device.
32	0x20	A Read Block I/O COMMREQ specified an invalid offset value.
33	0x21	An internal error has been detected in the PNC COMMREQ firmware.
34	0x22	The COMMREQ request is not supported by the specified Genius device.
35	0x23	The data type code specified for a Read Data or Write Data COMMREQ does not have a value recognized by the High-Speed Counter.
36	0x24	The counter number specified for a Read Data or Write Data COMMREQ does not have a value recognized by the High-Speed Counter.

VALUE decimal (word)	VALUE Hex (word)	DESCRIPTION
37	0x25	A Read Configuration or Write Configuration COMMREQ was issued for a device that does not have any configuration data.
38	0x26	A Read Diagnostics COMMREQ was issued for a device that does not have any diagnostic data.
39	0x27	A Read Device or Write Device COMMREQ specified an invalid program name when attempting to access %P or %L memory.
40	0x28	A Read Device or Write Device COMMREQ specified an invalid block name when attempting to access %L memory.
41	0x29	A Genius Reply does not have the expected sub-function code. This could indicate that the Gateway delivered a stale or out-of-sequence reply.
42	0x2A	A Read Device or Write Device COMMREQ sent to a 90-30 GBC (BEM331) attempted to access memory types (%P, %L, %W) not handled by the BEM331.



### Example: Ladder Logic to Clear Circuit Fault

The ladder logic displayed in Figure 25 shows how to clear a fault on circuit #2 of the Genius Device at SBA#13 when connected via a Genius Gateway to the PROFINET Controller located at Rack 0 Slot 7. Figure 26 uses a Data\_Init\_Comm to set up the same COMMREQ.

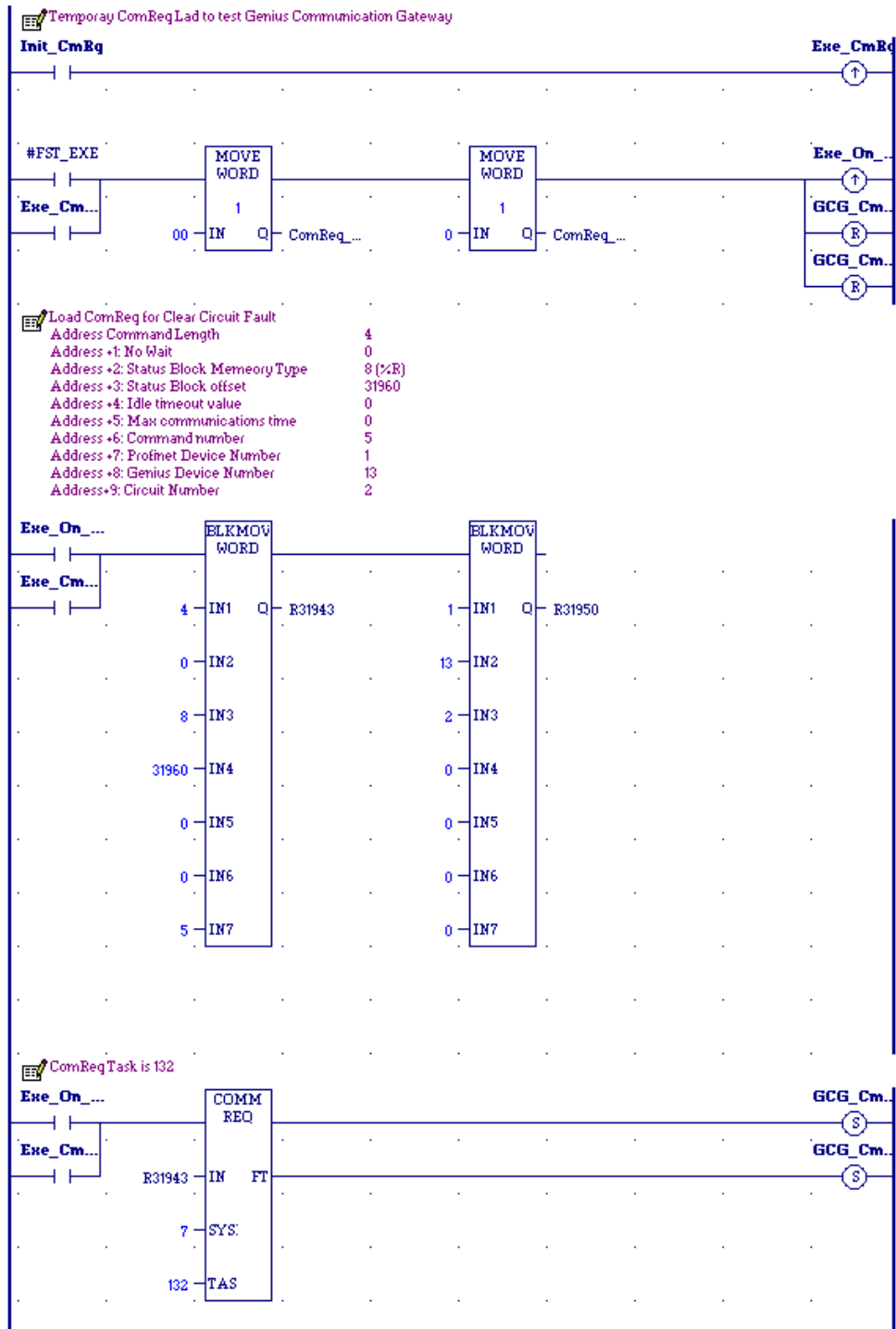

Figure 25: Ladder Logic to Clear Circuit Fault

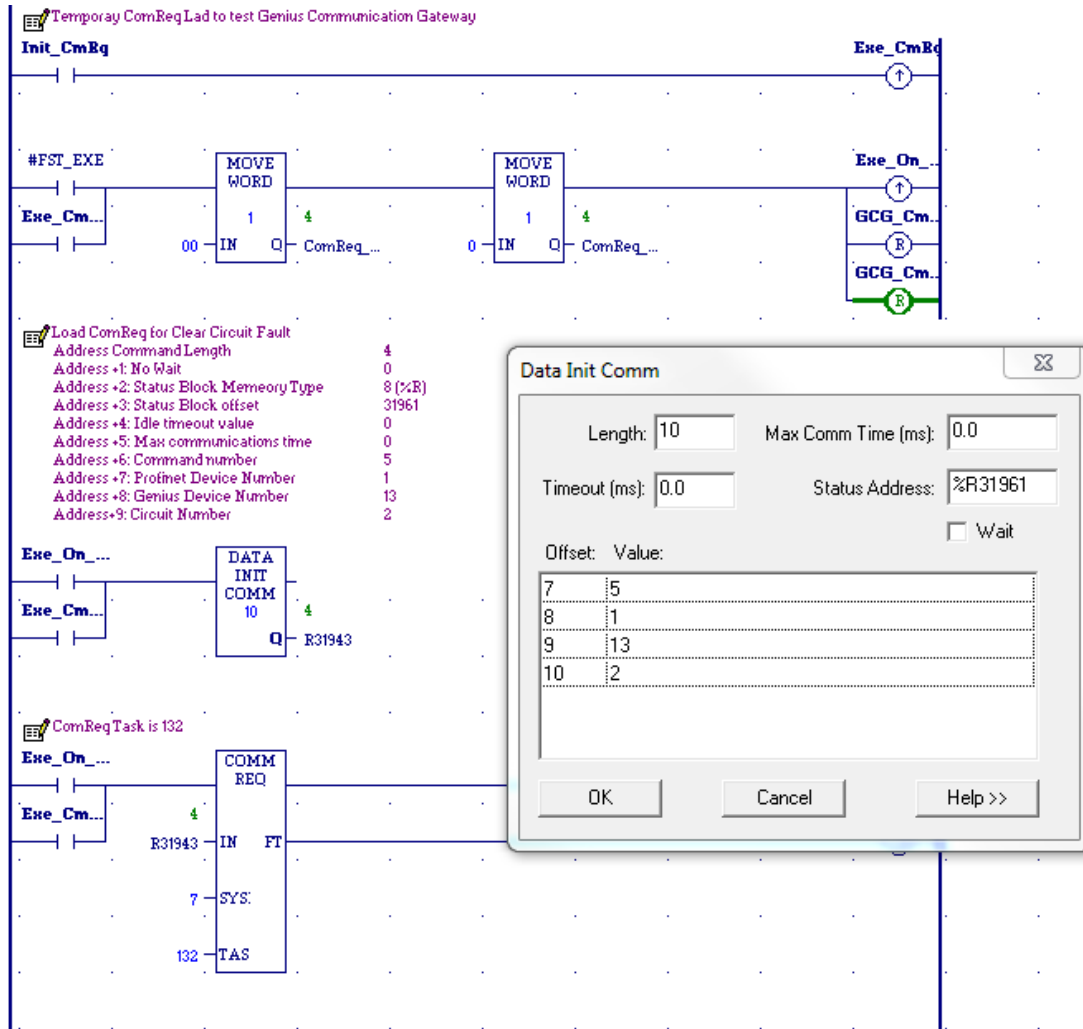

Figure 26: Data\_Init\_Comm to Clear Circuit Fault

### 6.3.5 Comparison: COMMREQ vs Data\_Init\_Comm

Data\_Init\_Comm is an instruction designed to help programmers set up COMMREQs. Note that when programming a COMMREQ (Figure 25), the entry for **Address+3** is one less than the intended beginning address for the Status Block. When programming a Data\_Init\_Comm (Figure 26), the entry for **Address+3** is the actual intended memory location for the beginning address for the Status Block.

This difference applies to all command blocks detailed in the following sections 6.4.1 - 6.4.16. If the COMMREQ requires “n” for the Status Block location, the equivalent Data\_Init\_Comm will require “n+1” in its **Address+3**.

Also note that the pop-up window presented in Data\_Init\_Comm (as shown in Figure 26), allows the user to scroll through the parameters of the command. This is especially useful where the command has multiple parameters.

### 6.3.6 COMMREQ Differences: Genius Bus Controllers and Genius Gateway

COMMREQs supported by the Genius Gateway (GCG) are intended to perform the same functions as their Genius Bus Controller (GBC) counterparts. However there are four significant differences that break compatibility with the GBC COMMREQ Command Blocks:

1. GCG COMMREQs require a PROFINET Device Number at Address +7. This value is required to identify which PROFINET /GCG combination is expected to process the COMMREQ.
2. As a result of (1) above, any COMMREQ command parameters above Address +7 are shifted with respect to the comparable GBC COMMREQ.
3. SYSID consists of the Rack/Slot location of the PROFINET Controller networked to the targeted GCG rather than the Rack/Slot location of the GBC.
4. For COMMREQs that return data to CPU memory, e.g., Read Configuration, the Memory Offset field has been expanded from one to two words. This allows the use of bulk memory (%W) addresses greater than 65,535. When using offsets less than or equal to 65,535, the more significant offset word must be zero.

The following table shows all Genius COMMREQs and where they are supported.

COMMREQ#	Function	GCG	GBC 30	GBC 70
1	Pulse Test	✓		✓
2	Read Configuration	✓		✓
3	Write Configuration	✓		✓
4	Read Diagnostics	✓		✓
5	Clear Circuit Fault	✓		✓
6	Clear All Circuit Faults	✓		✓
7	Assign Monitor	✓		✓
8	Outputs Enable/Disable		✓	✓
9	Global Data Enable/Disable			✓
10	Switch BSM			✓
11	Read Device	✓		✓
12	Write Device	✓		✓
13	De-Queue Datagram		✓	✓
14	Send Datagram		✓	✓
15	Request Datagram Reply		✓	✓
16	I/O Faults Enable/Disable			✓
17	Do Output			✓
18	Read Bus Address of Bus Controller			✓
19	Read Identification	✓		
20	Write Point	✓		
21	Read Block I/O	✓		
22	Read Map	✓		
23	Write Map	✓		
24	Read Data	✓		
25	Write Data	✓		

## 6.4 COMMREQ Descriptions and Formats

### 6.4.1 COMMREQ #1: Pulse Test Command

The Pulse Test command causes the Genius Gateway to send a Pulse Test datagram.

Pulse testing is used to verify the operation of outputs on discrete Genius I/O blocks. It checks whether the outputs will change state, and whether output circuits (wires, power sources, loads) will start or stop current flow. Any circuit faults generated by pulse tests are reported through the normal Report Fault message. Pulse testing is recommended for blocks that seldom change state. It is typically done once per hour, or once per shift; it should not be done more often than once per minute. Pulse testing provides assurance that when needed, an output will operate correctly. Blocks that control outputs that change state frequently do not need to be pulse tested. Pulse testing does not provide enough energy to activate mechanical devices such as motor starters, replays, or solenoid valves, but may change the state of a very small load. If appropriate, blocks can be configured (with the Hand-Held Monitor or via a Write Configuration command) to ignore a Pulse Test datagram. Pulse testing can also be done using a Hand-Held Monitor.

#### Command Block for the Pulse Test Command

<b>Address</b>	Command Length	3
<b>Address +1</b>	No Wait	0
<b>Address +2</b>	Status Block memory type	70 (%I), 72 (%Q), 8 (%R), 10 (%AI), 12 (%AQ) or 196 (%W)
<b>Address +3</b>	Status Block offset	Beginning address for the COMMREQ Status Block.
<b>Address +4</b>	Idle timeout value	0
<b>Address +5</b>	Max. communications time	0
<b>Address +6</b>	Command number	1
<b>Address +7</b>	PROFINET Device number	1-255: The device number of the targeted GCG Genius Gateway.
<b>Address +8</b>	Genius Device Number	0-31: the SBA of the targeted Genius Device.

### 6.4.2 COMMREQ #2: Read Configuration Command

The Read Configuration command is used to request configuration data from device on the Genius bus. It causes the Gateway to send a Read Configuration datagram to the indicated device. After receiving the request, the block returns its configuration data to the Gateway in 16-byte increments. When the Gateway has received all the configuration data, it transfers that complete data image to the PNC, which then transfers the data to the deposit memory location specified in the Command Block. Because configuration data consists of both bit-type and byte-type portions, it is best to place it in word memory, then move the bit-oriented data to bit memory. Contents of Read Configuration Reply messages for I/O blocks are shown in the Genius I/O System User's Manual.

#### Command Block for the Read Configuration Command

<b>Address</b>	Command Length	7
<b>Address +1</b>	No Wait	0
<b>Address +2</b>	Status Block memory type	70 (%I), 72 (%Q), 8 (%R), 10 (%AI), 12 (%AQ) or 196 (%W)
<b>Address +3</b>	Status Block offset	Beginning address for the COMMREQ Status Block.
<b>Address +4</b>	Idle timeout value	0
<b>Address +5</b>	Max. communications time	0
<b>Address +6</b>	Command number	2
<b>Address +7</b>	PROFINET Device number	1-255: The device number of the targeted GCG Genius Gateway.
<b>Address +8</b>	Genius Device Number	0-31: the SBA of the targeted Genius Device.
<b>Address +9</b>	Maximum data memory length. May represent either bits or words (depends on the memory type selected below).	<p>18 words (288 bits): any discrete block.                      13 words (208 bits): 16-Circuit AC Input block.                      42 words (672 bits): Analog blocks (4-in/2-out)                      42 words (672 bits): RTD or Thermocouple block.                      42 words (672 bits): 6-Input Analog blocks.                      35 words (560 bits): High-Speed Counter.</p> <p>If the length of data returned by the device exceeds the length specified here, the GCG writes as much data as possible to the PLC CPU Memory and returns a data error to the COMMREQ Status Block. The GCG will not write past the computed end-point.</p> <p>If the same COMMREQ will be used to read configuration data from more than one type of block (for example, in a subroutine), be sure to allow enough length to accommodate the largest amount of data that might be returned.</p>
<b>Address +10</b>	Deposit Memory type	Enter the code representing the CPU Memory Type where the GCG will deposit the data obtained from the target Genius Device. Use the same codes as in Address+2.
<b>Address +11</b> <b>Address +12</b>	Memory offset, bytes 1, 2 bytes 3, 4	Starting address within the Deposit Memory type. (Byte 4 is msb, Byte 1 is lsb)

### 6.4.3 COMMREQ #3: Write Configuration Command

The Write Configuration command is used to send configuration data from the CPU to a device on the Genius bus. The Gateway cannot write configuration data to another Genius Gateway, to a Bus Interface module, or to a Hand-Held Monitor.

The PLC sends the intended configuration data from CPU memory to the PNC which then transfers it to the Gateway. The Gateway schedules background Write Configuration datagrams to the target Genius device. Once message transmission begins, the Gateway sends the configuration data to the target Genius device, up to 16 bytes per bus scan. The block does not use any of the new configuration data until it has all been received. No new datagrams can be sent to the Genius device until the operation has been completed. When all the data has been sent, the Gateway changes the status to 4 (Done), and this is replicated by the PNC.

The length of the data sent with this command must exactly match the length specified for the target Genius device. If the lengths are not equal, the Gateway returns a Syntax Error to the COMMREQ Status Block.

#### Command Block for the Write Configuration Command

<b>Address</b>	Command Length	This number equals the sum of the amount of configuration data to be sent to the target Genius device, plus 4. For example, for an RTD block, which has 42 words of configuration data, you would enter 46 here. See "COMMREQ #2: Read Configuration" for data lengths associated with other Genius devices.
<b>Address +1</b>	No Wait	0
<b>Address +2</b>	Status Block memory type	70 (%I), 72 (%Q), 8 (%R), 10 (%AI), 12 (%AQ) or 196 (%W)
<b>Address +3</b>	Status Block offset	Beginning address for the COMMREQ Status Block.
<b>Address +4</b>	Idle timeout value	0
<b>Address +5</b>	Max. communications time	0
<b>Address +6</b>	Command number	3
<b>Address +7</b>	PROFINET Device number	1-255: The device number of the targeted GCG Genius Gateway.
<b>Address +8</b>	Genius Device Number	0-31: the SBA of the targeted Genius Device.
<b>Address +9</b>	Length of configuration data (in bytes)	Up to 248 bytes (128 words) of configuration data may be written to the target Genius device. See "COMMREQ #2: Read Configuration" for data lengths associated with other Genius devices.
<b>Address +10 to Address +n</b>	Configuration Data	Configuration data for transfer to the target Genius device. Formats are given in the <i>Genius I/O System User's Manual</i> .

### 6.4.4 COMMREQ #4: Read Diagnostics Command

Use this command to request diagnostic information from a Genius device or a bus interface module. Diagnostics can be requested from any Genius device, even those configured not to issue Report Fault messages. The diagnostic data returned by a block will indicate faults that have occurred since power-up or since the last Clear Faults datagram. Current diagnostic state can be found by issuing a Clear Faults command to the circuit(s) or channel(s) to clear the fault history, then issuing a Read Diagnostics command.

This command causes the Genius Gateway to send a Read Diagnostics datagram to the specified device. When the device receives this datagram, it returns a Read Diagnostics Reply datagram. I/O blocks return data in message segments of up to 16 bytes per bus scan. The content of the Read Diagnostics Reply message depends on the device being queried. The first word of the reply will contain the length of the data that follows. Data is packed two bytes per word. Message formats are shown in the *Genius I/O System User's Manual*. When all the data has been received, the Gateway transfers it to the PNC, which then transfers it to the CPU.

#### Command Block for the Read Diagnostics Command

<b>Address</b>	Command Length	7
<b>Address +1</b>	No Wait	0
<b>Address +2</b>	Status Block memory type	70 (%I), 72 (%Q), 8 (%R), 10 (%AI), 12 (%AQ) or 196 (%W)
<b>Address +3</b>	Status Block offset	Beginning address for the COMMREQ Status Block.
<b>Address +4</b>	Idle timeout value	0
<b>Address +5</b>	Max. communications time	0
<b>Address +6</b>	Command number	4
<b>Address +7</b>	PROFINET Device number	1-255: The device number of the targeted GCG Genius Gateway.
<b>Address +8</b>	Genius Device Number	0-31: the SBA of the targeted Genius Device.
<b>Address +9</b>	Maximum data memory length. May represent either bits or words (depends on the memory type selected below).	<p>This entry tells the CPU how much memory is being allocated to store the diagnostic data returned by the Genius device. The number of bits or words needed depends on the number of circuits on the block and the block type:</p> <p>10 words (160 bits): Discrete blocks, 8-ckt.  18 words (288 bits): Discrete blocks, 16-ckt.  34 words (544 bits): Discrete blocks, 32-ckt.  8 words (128 bits): Analog, 4-in/2-out blocks.  8 words (128 bits): RTD Input blocks.  8 words (128 bits): Thermocouple Input blocks.  6 words (96 bits): High-Speed Counter block.</p> <p>If the length of data returned by the device exceeds the length specified here, the GCG writes as much data as possible to the PLC CPU Memory and returns a data error to the COMMREQ Status Block. The GCG will not write past the computed end-point.</p>
<b>Address +10</b>	Deposit Memory type	Enter the code representing the CPU Memory Type where the GCG will deposit the data obtained from the target Genius Device. Use the same codes as in Address+2.
<b>Address +11</b> <b>Address +12</b>	Memory offset, bytes 1, 2 bytes 3, 4	Starting address within the Deposit Memory type. (Byte 4 is msb, Byte 1 is lsb)

### 6.4.5 COMMREQ #5: Clear Circuit Fault Command

This command is used to clear any faults on a specified circuit of a targeted Genius I/O device.

#### Command Block for the Clear Circuit Fault Command

<b>Address</b>	Command Length	4
<b>Address +1</b>	No Wait	0
<b>Address +2</b>	Status Block memory type	70 (%I), 72 (%Q), 8 (%R), 10 (%AI), 12 (%AQ) or 196 (%W)
<b>Address +3</b>	Status Block offset	Beginning address for the COMMREQ Status Block.
<b>Address +4</b>	Idle timeout value	0
<b>Address +5</b>	Max. communications time	0
<b>Address +6</b>	Command number	5
<b>Address +7</b>	PROFINET Device number	1-255: The device number of the targeted GCG Genius Gateway.
<b>Address +8</b>	Genius Device Number	0-31: the SBA of the targeted Genius Device.
<b>Address +9</b>	Relative Circuit Number	This is the relative number of the circuit within the Genius device. It is not its reference number assigned in CPU Memory. The first circuit on the Genius device is considered to be number 1. For example, to clear faults on discrete I/O block circuit #5, enter 5 here. For a 4-Input/2-Output analog block, circuit numbers 1 to 4 are for input channels, 5 and 6 are for output channels.

### 6.4.6 COMMREQ #6: Clear All Circuit Faults Command

The Clear All Circuit Faults command is used to clear all faults on a targeted Genius I/O device.

#### Command Block for the Clear All Circuit Faults Command

<b>Address</b>	Command Length	3
<b>Address +1</b>	No Wait	0
<b>Address +2</b>	Status Block memory type	70 (%I), 72 (%Q), 8 (%R), 10 (%AI), 12 (%AQ) or 196 (%W)
<b>Address +3</b>	Status Block offset	Beginning address for the COMMREQ Status Block.
<b>Address +4</b>	Idle timeout value	0
<b>Address +5</b>	Max. communications time	0
<b>Address +6</b>	Command number	6
<b>Address +7</b>	PROFINET Device number	1-255: The device number of the targeted GCG Genius Gateway.
<b>Address +8</b>	Genius Device Number	0-31 or 255: the SBA of the targeted Genius Device. Enter 255 to send this command to all blocks on the bus. <sup>1</sup>

<sup>1</sup> This enhancement (use of 255 as Genius Device Number) requires that the supervising PNC001 firmware be version 2.11 or later; otherwise the COMMREQ command will fail.



### 6.4.7 COMMREQ #7: Assign Monitor Command

An Assigned Monitor is an additional bus interface module (usually in another PLC) that monitors Genius I/O devices on the bus. Remote I/O Scanners and I/O blocks broadcast their inputs to all devices on the bus. Therefore, any interface module on the bus will receive all inputs sent by the blocks. However, blocks direct fault reports and configuration change messages only to the bus interface module that sends them outputs. Blocks configured for CPU Redundancy will automatically transmit two copies of any fault report or configuration change message, directing them to Device Numbers 30 and 31.

The Assign Monitor command can be used to have Genius I/O devices send extra fault report and configuration change messages to a monitoring bus interface module. Blocks would send two copies of each fault report or configuration message in a non-redundant system. Blocks in a redundant system would send three (two to the redundant bus interface modules, and the third to the Assigned Monitor).

#### Command Block for the Assign Monitor Command

<b>Address</b>	Command Length	4
<b>Address +1</b>	No Wait	0
<b>Address +2</b>	Status Block memory type	70 (%I), 72 (%Q), 8 (%R), 10 (%AI), 12 (%AQ) or 196 (%W)
<b>Address +3</b>	Status Block offset	Beginning address for the COMMREQ Status Block.
<b>Address +4</b>	Idle timeout value	0
<b>Address +5</b>	Max. communications time	0
<b>Address +6</b>	Command number	7
<b>Address +7</b>	PROFINET Device number	1-255: The device number of the targeted GCG Genius Gateway.
<b>Address +8</b>	Genius Device Number of the I/O device(s) that should send extra fault reports.	0-31: the SBA of a sending Genius Device. In the event only selected blocks should report their faults to the assigned monitor, program separate Assign Monitor commands for each, entering a different SBA in this field each time.
<b>Address +9</b>	Genius Device Number of the bus interface device that will RECEIVE the extra fault reports.	0-31: the SBA of the receiving Genius Device (i.e. the Assigned Monitor).

### 6.4.8 COMMREQ #11: Read Device Command

To read up to 128 bytes of data from another CPU and place it in the host PLC CPU memory, use the Read Device command. This causes the Genius Gateway to issue a Read Device datagram. When the requested data is received, it will automatically be placed in the CPU memory location specified in the Command Block.

Note that while the GCG001 does support this COMMREQ, the Genius devices which respond to such a COMMREQ are not currently supported by the GCG001.

#### Command Block for the Read Device Command

<b>Address</b>	Command Length	18
<b>Address +1</b>	No Wait	0
<b>Address +2</b>	Status Block memory type	70 (%I), 72 (%Q), 8 (%R), 10 (%AI), 12 (%AQ) or 196 (%W)
<b>Address +3</b>	Status Block offset	Beginning address for the COMMREQ Status Block.
<b>Address +4</b>	Idle timeout value	0
<b>Address +5</b>	Max. communications time	0
<b>Address +6</b>	Command number	11
<b>Address +7</b>	PROFINET Device number	1-255: The device number of the targeted GCG Genius Gateway.
<b>Address +8</b>	Genius Device Number	0-31: the SBA of the targeted Genius Device from which data is to be retrieved.
<b>Address +9</b> <b>Address +10</b>	Source Memory Address, bytes 1, 2 bytes 3, 4	Specify the location FROM which the requested data will be read. (It is not necessary to specify a source memory address when sending a Read Device COMREQ to a computer).
<b>Address +11</b> <b>Address +12</b> <b>Address +13</b> <b>Address +14</b>	Program name, characters 1, 2 characters 3, 4 characters 5, 6 characters 7, 8	Required to read %P or %L memory in another PLC, otherwise zero. If the target of the command is NOT a PLC, Address +11 through Address +18 are ignored; they may contain any value. Program names are limited to 7 characters. Character 8 and all other trailing characters MUST be entered as nulls (00h).
<b>Address +15</b> <b>Address +16</b> <b>Address +17</b> <b>Address +18</b>	Block name, characters 1, 2 characters 3, 4 characters 5, 6 characters 7, 8	Required to read %L memory in a PLC, otherwise zero. For %P, Address+15 through Address +18 are ignored. Block names are limited to 7 characters. Character 8 and all other trailing characters MUST be entered as nulls (00h).
<b>Address +19</b>	Source Data length, (in words, bytes, or bits).	This is the amount of data to be read from the targeted device. When reading a PLC, data length is defined in bits or words, depending on the memory type being read. For other types of devices, the length entered here is as expected by the target device. The maximum length is equal to 128 bytes.
<b>Address +20</b>	Maximum Deposit memory length	Memory length needed for the returned data. Value in bits or words (depends on memory type selected in Address+21 below).
<b>Address +21</b>	Deposit Memory type	Enter the code representing the CPU Memory Type where the GCG will deposit the data obtained from the target Genius Device. Use the same codes as in Address+2.
<b>Address +22</b> <b>Address +23</b>	Memory offset, bytes 1, 2 bytes 3, 4	Starting address within the Deposit Memory type. (Byte 4 is msb, Byte 1 is lsb)

#### Device Memory Addressing

For Series 90 and PACSystems PLCs, Address+9 contains the segment selector value for the memory type being read. Address+10 contains the zero-based offset into the memory being read.

For legacy devices, use an absolute address, where Address+9 is the least-significant word of the address and Address+10 is the most-significant word of the address field.

### 6.4.9 COMMREQ #12: Write Device Command

To send up to 128 bytes of data to another CPU on the bus, use the Write Device command. Any type of data that can be addressed by its memory type and offset can be sent. This command causes the Gateway to issue a Write Device datagram to the specified device.

Note that while the GCG001 does support this COMMREQ, the Genius devices which respond to such a COMMREQ are not currently supported by the GCG001.

#### Using Write Device Messages Instead of Global Data

Write Device datagrams can replace Global Data when the target device is a PLC that is using a Genius Bus Controller to connect to the Genius bus. However, Write Device will not work in this manner when the target PLC is using a Genius Gateway to connect to the Genius bus.

#### Command Block for the Write Device Command

<b>Address</b>	Command Length	14 – 78 depending on length of data specified in Address +19.
<b>Address +1</b>	No Wait	0
<b>Address +2</b>	Status Block memory type	70 (%I), 72 (%Q), 8 (%R), 10 (%AI), 12 (%AQ) or 196 (%W)
<b>Address +3</b>	Status Block offset	Beginning address for the COMMREQ Status Block.
<b>Address +4</b>	Idle timeout value	0
<b>Address +5</b>	Max. communications time	0
<b>Address +6</b>	Command number	12
<b>Address +7</b>	PROFINET Device number	1-255: The device number of the targeted GCG Genius Gateway.
<b>Address +8</b>	Genius Device Number	0-31: the SBA of the targeted Genius Device to which data is to be transmitted.
<b>Address +9</b> <b>Address +10</b>	Target Memory Address, bytes 1, 2 bytes 3, 4	Specify the location TO which the supplied data will be transmitted. (It is not necessary to specify a source memory address when sending a Write Device COMREQ to a computer).
<b>Address +11</b> <b>Address +12</b> <b>Address +13</b> <b>Address +14</b>	Program name, characters 1, 2 characters 3, 4 characters 5, 6 characters 7, 8	Required to write to %P or %L memory in another PLC, otherwise zero. If the target of the command is NOT a PLC, Address +11 through Address +18 are ignored; they may contain any value. Program names are limited to 7 characters. Character 8 and all other trailing characters MUST be entered as nulls (00h).
<b>Address +15</b> <b>Address +16</b> <b>Address +17</b> <b>Address +18</b>	Block name, characters 1, 2 characters 3, 4 characters 5, 6 characters 7, 8	Required to write to %L memory in a PLC, otherwise zero. For %P, Address+15 through Address +18 are ignored. Block names are limited to 7 characters. Character 8 and all other trailing characters MUST be entered as nulls (00h).
<b>Address +19</b>	Target Data length, (in words, bytes, or bits).	This is the amount of data to be written to the targeted device. When reading a PLC, data length is defined in bits or words, depending on the memory type being written. For other types of devices, the length entered here is as expected by the target device. The maximum length is equal to 128 bytes.
<b>Address +20</b> to <b>Address +n</b>	Data	Data to be transmitted, then written into the specified memory of the target device.

### 6.4.10 COMMREQ #19: Read Identification

To read the identification data from a Genius device and place it in PLC CPU memory, use the Read Identification command. This causes the Gateway to issue a Read Identification datagram. When the data is received from the target Genius device, via a Read Identification Reply Datagram, it will automatically be placed in the CPU memory location specified in the Command Block.

#### Command Block for the Read Identification Command

<b>Address</b>	Command Length	7
<b>Address +1</b>	No Wait	0
<b>Address +2</b>	Status Block memory type	70 (%I), 72 (%Q), 8 (%R), 10 (%AI), 12 (%AQ) or 196 (%W)
<b>Address +3</b>	Status Block offset	Beginning address for the COMMREQ Status Block.
<b>Address +4</b>	Idle timeout value	0
<b>Address +5</b>	Max. communications time	0
<b>Address +6</b>	Command number	19
<b>Address +7</b>	PROFINET Device number	1-255: The device number of the targeted GCG Genius Gateway.
<b>Address +8</b>	Genius Device Number	0-31: the SBA of the targeted Genius Device.
<b>Address +9</b>	Deposit Memory length. (either bits or words)	This entry tells the CPU how much memory is being allocated to store the identification data returned by the Genius device. Enter 6 for word memory types or 96 for bit memory types (depends on the memory type selected as the Deposit Memory type below).
<b>Address +10</b>	Deposit Memory type	Enter the code representing the CPU Memory Type where the GCG will deposit the data obtained from the target Genius Device. Use the same codes as in Address+2.
<b>Address +11</b> <b>Address +12</b>	Memory offset, bytes 1, 2 bytes 3, 4	Starting address within the Deposit Memory type. (Byte 4 is msb, Byte 1 is lsb)

#### Read Identification Reply Data

The datagram returned by the target Genius Device has the following data content:

Word #	Description		
	<b>MSB</b>	<b>LSB</b>	
0	Output data length (bytes)	Input data length (bytes)	
1	Number of diagnostic data bytes	Number of configuration data bytes	
2	Device Status Table Address (lsb)	Device Status Bits	
		<b>Bit</b> <b>Description</b>	
		0            Device Forced if set to 1	
		1,2         01 = inputs only 10 = outputs only 11 = combination	
		3            HHM Present if set to 1	
		4            BSM Present if set to 1	
		5            BSM Controller if set to 1	
		6            BSM Actual State	
7            BSM Forced if set to 1			
3	Device Model Number OR GENA application ID if a GENA	Device Status Table Address (msb)	
4	Assigned controller bus address OR S6 GBC DIP switch, if S6 GBC OR GENA application rev #, if GENA	Device Software Revision Number	
5	Baud Rate Code		
	<b>Bits</b> <b>Baud Rate</b>	Device Model Number	
	0 0 0 0 x x x x		153.6 K baud, extended
	0 0 0 1 x x x x		153.6 K baud, standard
	0 0 1 0 x x x x		76.8 K baud
0 0 1 1 x x x x	38.4 K baud		

### 6.4.11 COMMREQ #20: Write Point Command

This command is intended for use with legacy devices that use absolute memory addressing, such as the Series Six. For Series 90 and PACSystems PLCs, use the Write Device command.

Note that while the GCG001 does support this COMMREQ, the Genius devices which respond to such a COMMREQ are not currently supported by the GCG001.

#### Command Block for the Write Point Command

<b>Address</b>	Command Length	7
<b>Address +1</b>	No Wait	0
<b>Address +2</b>	Status Block memory type	70 (%I), 72 (%Q), 8 (%R), 10 (%AI), 12 (%AQ) or 196 (%W)
<b>Address +3</b>	Status Block offset	Beginning address for the COMMREQ Status Block.
<b>Address +4</b>	Idle timeout value	0
<b>Address +5</b>	Max. communications time	0
<b>Address +6</b>	Command number	20
<b>Address +7</b>	PROFINET Device number	1-255: The device number of the targeted GCG Genius Gateway.
<b>Address +8</b>	Genius Device Number	0-31: the SBA of the targeted Genius Device to which data is to be transmitted.
<b>Address +9</b> <b>Address +10</b>	Target Device Address bytes 1, 2 bytes 3, 4	Address within target device to be modified per the AND and OR masks supplied below. Byte 1 is lsb of this address, Byte 4 is msb.
<b>Address +11</b>	AND and OR Masks for byte 1	AND mask is in the LSB OR mask is in the MSB
<b>Address +12</b>	AND and OR Masks for byte 2	AND mask is in the LSB OR mask is in the MSB

### 6.4.12 COMMREQ #21: Read Block I/O Command

This command is used to read input and output data from the following Genius blocks:

- 4-Input/2-Output Analog Blocks
- Current-source Analog Blocks
- Thermocouple Input Blocks

The data available to this command includes the I/O data that is part of the block's periodic I/O update as well as other related data, such as the raw counts.

#### Command Block for the Read Block I/O Command

<b>Address</b>	Command Length	8
<b>Address +1</b>	No Wait	0
<b>Address +2</b>	Status Block memory type	70 (%I), 72 (%Q), 8 (%R), 10 (%AI), 12 (%AQ) or 196 (%W)
<b>Address +3</b>	Status Block offset	Beginning address for the COMMREQ Status Block.
<b>Address +4</b>	Idle timeout value	0
<b>Address +5</b>	Max. communications time	0
<b>Address +6</b>	Command number	21
<b>Address +7</b>	PROFINET Device number	1-255: The device number of the targeted GCG Genius Gateway.
<b>Address +8</b>	Genius Device Number	0-31: the SBA of the targeted Genius Device from which data is to be retrieved.
<b>Address +9</b>	Length	Length of data to be returned by the target Genius device. Value in bits or words, depending on memory type selected below
<b>Address +10</b>	Deposit Memory type	Enter the code representing the CPU Memory Type where the GCG will deposit the data obtained from the target Genius Device. Use the same codes as in Address+2.
<b>Address +11</b> <b>Address +12</b>	Memory offset, bytes 1, 2 bytes 3, 4	Starting address within the Deposit Memory type. (Byte 4 is msb, Byte 1 is lsb)
<b>Address +13</b>	I/O Offset	Byte offset from the beginning of the device's I/O data (zero-based).

#### I/O Data Format Returned by 4-In/2-Out Analog and Strain Gauge/mV Blocks

Byte #	Description
0	Block Model Number
1	Block Software Revision Number
2	A/D value for Input Channel 1 (LSB)
3	A/D value for Input Channel 1 (MSB)
4-5	A/D value for Input Channel 2
6-7	A/D value for Input Channel 3
8-9	A/D value for Input Channel 4
10	D/A value for Output Channel 1 (LSB) *
11	D/A value for Output Channel 1 (MSB) *
12-13	D/A value for Output Channel 2 *
14	Engineering Units value for input channel 1 (LSB)
15	Engineering Units value for input channel 1 (MSB)
16-17	Engineering Units value for input channel 2
18-19	Engineering Units value for input channel 3
20-21	Engineering Units value for input channel 4
22	Engineering Units value for output channel 1 (LSB) *
23	Engineering Units value for output channel 1 (MSB) *
24-25	Engineering Units value for output channel 2 *

### I/O Data Format Returned by Current Source Analog (CSA) Blocks

Byte #	Description
0	Block Model Number
1	Block Software Revision Number
2	µA value for Input Channel 1 (LSB)
3	µA value for Input Channel 1 (MSB)
4-5	µA value for Input Channel 2
6-7	µA value for Input Channel 3
8-9	µA value for Input Channel 4
10-11	µA commanded value for output channel 1
12-13	µA commanded value for output channel 2
14	Engineering Units value for input channel 1 (LSB)
15	Engineering Units value for input channel 1 (MSB)
16-17	Engineering Units value for input channel 2
18-19	Engineering Units value for input channel 3
20-21	Engineering Units value for input channel 4
22-23	Engineering Units value for output channel 1
24-25	Engineering Units value for output channel 2
26	µA Feedback value for output channel 1 (LSB)
27	µA Feedback value for output channel 1 (MSB)
28-29	µA Feedback value for output channel 2
30	Engineering Units feedback value for output channel 1 (LSB)
31	Engineering Units feedback value for output channel 1 (MSB)
32-33	Engineering Units feedback value for output channel 2

### I/O Data Format Returned by Current Source Output (CSO) Blocks

Byte #	Description
0	Block Model Number
1	Block Software Revision Number
2	µA commanded value for output channel 1 (LSB)
3	µA commanded value for output channel 1 (MSB)
4-5	µA commanded value for output channel 2
6-7	µA commanded value for output channel 3
8-9	µA commanded value for output channel 4
10-11	µA commanded value for output channel 5
12-13	µA commanded value for output channel 6
14	Engineering Units value for output channel 1 (LSB)
15	Engineering Units value for output channel 1 (MSB)
16-17	Engineering Units value for output channel 2
18-19	Engineering Units value for output channel 3
20-21	Engineering Units value for output channel 4
22-23	Engineering Units value for output channel 5
24-25	Engineering Units value for output channel 6

**I/O Data Format Returned by Current Source Input (CSI) Blocks**

Byte #	Description
0	Block Model Number
1	Block Software Revision Number
2	$\mu$ A value for input channel 1 (LSB)
3	$\mu$ A value for input channel 1 (MSB)
4-5	$\mu$ A value for input channel 2
6-7	$\mu$ A value for input channel 3
8-9	$\mu$ A value for input channel 4
10-11	$\mu$ A value for input channel 5
12-13	$\mu$ A value for input channel 6
14	Engineering Units value for input channel 1 (LSB)
15	Engineering Units value for input channel 1 (MSB)
16-17	Engineering Units value for input channel 2
18-19	Engineering Units value for input channel 3
20-21	Engineering Units value for input channel 4
22-23	Engineering Units value for input channel 5
24-25	Engineering Units value for input channel 6



### I/O Data Format Returned by Thermocouple Input Block

Byte #	Description
0	Block Model Number
1	Block Software Revision Number
2	Channel 1 T/C input voltage (hundredths of mV) (LSB)
3	Channel 1 T/C input voltage (hundredths of mV) (MSB)
4-5	Channel 2 T/C input voltage (hundredths of mV)
6-7	Channel 3 T/C input voltage (hundredths of mV)
8-9	Channel 4 T/C input voltage (hundredths of mV)
10-11	Channel 5 T/C input voltage (hundredths of mV)
12-13	Channel 6 T/C input voltage (hundredths of mV)
14	Channel 1 Engineering Units value (LSB)
15	Channel 1 Engineering Units value (MSB)
16-17	Channel 2 Engineering Units value
18-19	Channel 3 Engineering Units value
20-21	Channel 4 Engineering Units value
22-23	Channel 5 Engineering Units value
24-25	Channel 6 Engineering Units value
26	Channel 1/2 XJV voltage (hundredths of mV) (LSB)
27	Channel 1/2 XJV voltage (hundredths of mV) (MSB)
28-29	Channel 3/4 XJV voltage (hundredths of mV)
30-31	Channel 5/6 XJV voltage (hundredths of mV)
32	Channel 1/2 XJV temperature (tenths of degrees C) (LSB)
33	Channel 1/2 XJV temperature (tenths of degrees C) (MSB)
34-35	Channel 3/4 XJV temperature (tenths of degrees C)
36-37	Channel 5/6 XJV temperature (tenths of degrees C)
38	Channel 1/2 XJI current (tenths of $\mu$ A) (LSB)
39	Channel 1/2 XJI current (tenths of $\mu$ A) (MSB)
40-41	Channel 3/4 XJI current (tenths of $\mu$ A)
42-43	Channel 5/6 XJI current (tenths of $\mu$ A)
44	Channel 1/2 XJI temperature (tenths of degrees C) (LSB)
45	Channel 1/2 XJI temperature (tenths of degrees C) (MSB)
46-47	Channel 3/4 XJI temperature (tenths of degrees C)
48-49	Channel 5/6 XJI temperature (tenths of degrees C)
50	Channel 1/2 internal CJS current (tenths of $\mu$ A) (LSB)
51	Channel 1/2 internal CJS current (tenths of $\mu$ A) (MSB)
52-53	Channel 3/4 internal CJS current (tenths of $\mu$ A)
54-55	Channel 5/6 internal CJS current (tenths of $\mu$ A)
56	Channel 1/2 internal CJS temperature (tenths of degrees C) (LSB)
57	Channel 1/2 internal CJS temperature (tenths of degrees C) (MSB)
58-59	Channel 3/4 internal CJS temperature (tenths of degrees C)
60-61	Channel 5/6 internal CJS temperature (tenths of degrees C)
62-73	Reserved

### 6.4.13 COMMREQ #22: Read Map Command

To read the I/O mapping configuration from a 90-70 Remote Scanner, use the Read Map Command. When the data is received, it will automatically be placed in the CPU memory location specified in the Command Block.

#### Command Block for the Read Map Command

<b>Address</b>	Command Length	7
<b>Address +1</b>	No Wait	0
<b>Address +2</b>	Status Block memory type	70 (%I), 72 (%Q), 8 (%R), 10 (%AI), 12 (%AQ) or 196 (%W)
<b>Address +3</b>	Status Block offset	Beginning address for the COMMREQ Status Block.
<b>Address +4</b>	Idle timeout value	0
<b>Address +5</b>	Max. communications time	0
<b>Address +6</b>	Command number	22
<b>Address +7</b>	PROFINET Device number	1-255: The device number of the targeted GCG Genius Gateway.
<b>Address +8</b>	Genius Device Number	0-31: the SBA of the targeted Genius Device.
<b>Address +9</b>	Deposit Memory Length (either bits or words)	This entry tells the CPU how much memory is being allocated to store the data returned by the Genius device. Value specified in bits or words, depending on memory type selected below. (8 words or 128 bits)
<b>Address +10</b>	Deposit Memory type	Enter the code representing the CPU Memory Type where the GCG will deposit the data obtained from the target Genius Device. Use the same codes as in Address+2.
<b>Address +11</b> <b>Address +12</b>	Memory offset, bytes 1, 2 bytes 3, 4	Starting address within the Deposit Memory type. (Byte 4 is msb, Byte 1 is lsb)

#### Read Map Returned Data

Byte #	Description
0	Remote Rack ID
1-2	%I Starting Reference
3	Length of %I data (bytes)
4-5	%AI Starting Reference
6	Length of %AI data (bytes)
7-8	%Q Starting Reference
9	Length of %Q data (bytes)
10-11	%AQ Starting Reference
12	Length of %AQ data (bytes)
13	8-bit additive checksum
14-15	16-bit LRC checksum

### 6.4.14 COMMREQ #23: Write Map Command

To set the reference table mapping of a 90-70 Remote Scanner on the Genius bus, use the Write Map command.

#### Command Block for the Write Map Command

<b>Address</b>	Command Length	11
<b>Address +1</b>	No Wait	0
<b>Address +2</b>	Status Block memory type	70 (%I), 72 (%Q), 8 (%R), 10 (%AI), 12 (%AQ) or 196 (%W)
<b>Address +3</b>	Status Block offset	Beginning address for the COMMREQ Status Block.
<b>Address +4</b>	Idle timeout value	0
<b>Address +5</b>	Max. communications time	0
<b>Address +6</b>	Command number	23
<b>Address +7</b>	PROFINET Device number	1-255: The device number of the targeted GCG Genius Gateway.
<b>Address +8</b>	Genius Device Number	0-31: the SBA of the targeted Genius Device to which data is to be transmitted.
<b>Address +9 to Address +16</b>	Data to be written to the target device.	Same format as Read Map Returned Data described above. The checksums will be ignored.

### 6.4.15 COMMREQ #24: Read Data Command

This command is used to read data from a Genius High-Speed Counter. When the data is received, it will be placed in the CPU memory location specified in the Command Block.

#### Command Block for the Read Data Command

<b>Address</b>	Command Length	9
<b>Address +1</b>	No Wait	0
<b>Address +2</b>	Status Block memory type	70 (%I), 72 (%Q), 8 (%R), 10 (%AI), 12 (%AQ) or 196 (%W)
<b>Address +3</b>	Status Block offset	Beginning address for the COMMREQ Status Block.
<b>Address +4</b>	Idle timeout value	0
<b>Address +5</b>	Max. communications time	0
<b>Address +6</b>	Command number	24
<b>Address +7</b>	PROFINET Device number	1-255: The device number of the targeted GCG Genius Gateway.
<b>Address +8</b>	Genius Device Number	0-31: the SBA of the targeted Genius HSC Device from which data is to be retrieved.
<b>Address +9</b>	Deposit Memory Length	This entry tells the CPU how much memory is being allocated to store the data returned by the Genius device. The value (in bytes or bits) depends on the memory type selected as the Deposit Memory type in <b>Address +10</b> below. When a HSC block is configured as a Type A counter, enter 2 for word memory types or 32 for bit memory types. However, when configured as a Type B or Type C counter, enter 3 for word memory types or 48 for bit memory types. Note that the Read Data Reply Datagram always responds with six bytes of data. The most significant bytes (Byte 4 & Byte 5) are null. Bytes 0 thru Byte 3 contain the HSC Data requested.
<b>Address +10</b>	Deposit Memory type	Enter the code representing the CPU Memory Type where the GCG will deposit the data obtained from the target Genius Device. Use the same codes as in Address+2.
<b>Address +11</b> <b>Address +12</b>	Memory offset, bytes 1, 2 bytes 3, 4	Starting address within the Deposit Memory type. (Byte 4 is msb, Byte 1 is lsb)
<b>Address +13</b>	Command Code	See Read/Write Data Command Code Table below.
<b>Address +14</b>	Counter Number	1 - 4

### 6.4.16 COMMREQ #25: Write Data Command

This command is used to set data values in a Genius High-speed Counter.

#### Command Block for the Write Data Command

<b>Address</b>	Command Length	7
<b>Address +1</b>	No Wait	0
<b>Address +2</b>	Status Block memory type	70 (%I), 72 (%Q), 8 (%R), 10 (%AI), 12 (%AQ) or 196 (%W)
<b>Address +3</b>	Status Block offset	Beginning address for the COMMREQ Status Block.
<b>Address +4</b>	Idle timeout value	0
<b>Address +5</b>	Max. communications time	0
<b>Address +6</b>	Command number	25
<b>Address +7</b>	PROFINET Device number	1-255: The device number of the targeted GCG Genius Gateway.
<b>Address +8</b>	Genius Device Number	0-31: the SBA of the targeted Genius Device to which data is to be transmitted.
<b>Address +9</b>	Command Code	See Read/Write Data Command Code Table below.
<b>Address +10</b>	Counter Number	1-4
<b>Address +11</b> <b>Address +12</b>	Data to be written bytes 1, 2 bytes 3, 4	Four bytes of data to be written to the target Genius HSC (Byte 4 is msb, Byte 1 is lsb)

### Read/Write Data Command Codes for COMMREQs #24 & #25

These commands are used with the Read Data and Write Data COMMREQs to read or write data to a Genius High-speed Counter block. The Load and Set command codes are used in conjunction with the Write Data COMMREQ and the Read command codes are used by the Read Data COMMREQ. In the following descriptions, 'n' represents the counter number.

Command (Decimal)	Command (Hex)	Command Description
0	0000	Null command
1	0001	Load/Read Accumulator n
2	0002	Load/Read Hi Limit n
3	0003	Load/Read Lo Limit n
4	0004	Load Accumulator n Increment
5	0005	Set/Read Counter Direction (Type A counter n only)
6	0006	Load Time Base n
8	0008	Load/Read Home Position n
11	000B	Load/Read ON Preset n.1
12	000C	Load/Read ON Preset n.2
13	000D	Load/Read ON Preset n.3
14	000E	Load/Read ON Preset n.4
21	0015	Load/Read OFF Preset n.1
22	0016	Load/Read OFF Preset n.2
23	0017	Load/Read OFF Preset n.3
24	0018	Load/Read OFF Preset n.4
31	001F	Load/Read PRELOAD n.1
32	0020	Load/Read PRELOAD n.2
50	0032	Load/Read Oscillator Divisor





**GE Intelligent Platforms**

1-800-433-2682  
1-434-978-5100  
[www.ge-ip.com](http://www.ge-ip.com)

GFK-2892A