

# GFK-2193

[Buy GE Fanuc Series 90-30 NOW!](#)

## GE Fanuc Manual Series 90-30

PROFIBUS Slave Module

1-800-360-6802

[sales@pdfsupply.com](mailto:sales@pdfsupply.com)



# ***GE Fanuc Automation***

---

***Programmable Control Products***

***Series 90™-30  
PROFIBUS Slave Module***

***User's Manual***

GFK-2193

June 2002

## *Warnings, Cautions, and Notes as Used in this Publication*

### **Warning**

**Warning notices are used in this publication to emphasize that hazardous voltages, currents, temperatures, or other conditions that could cause personal injury exist in this equipment or may be associated with its use.**

**In situations where inattention could cause either personal injury or damage to equipment, a Warning notice is used.**

### **Caution**

**Caution notices are used where equipment might be damaged if care is not taken.**

**Note:** Notes merely call attention to information that is especially significant to understanding and operating the equipment.

This document is based on information available at the time of its publication. While efforts have been made to be accurate, the information contained herein does not purport to cover all details or variations in hardware or software, nor to provide for every possible contingency in connection with installation, operation, or maintenance. Features may be described herein which are not present in all hardware and software systems. GE Fanuc Automation assumes no obligation of notice to holders of this document with respect to changes subsequently made.

GE Fanuc Automation makes no representation or warranty, expressed, implied, or statutory with respect to, and assumes no responsibility for the accuracy, completeness, sufficiency, or usefulness of the information contained herein. No warranties of merchantability or fitness for purpose shall apply.

The following are trademarks of GE Fanuc Automation North America, Inc.

Alarm Master	Genius	PowerMotion	VersaMax
CIMPLICITY	Helpmate	PowerTRAC	VersaPro
CIMPLICITY 90-ADS	Logicmaster	Series 90	VuMaster
CIMSTAR	Modelmaster	Series Five	Workmaster
Field Control	Motion Mate	Series One	
FrameworkX	ProLoop	Series Six	
GEnet	PROMACRO	Series Three	

## **Content of This Manual**

This manual provides instructions for installing, programming, and troubleshooting control systems that use the Series 90-30 PROFIBUS slave module, IC693PBS201. It is assumed that you have a basic understanding of Series 90-30 PLCs and are familiar with PROFIBUS-DP protocol.

## **Related Publications**

*Series 90-30 Profibus Master Module User's Manual, GFK-2121*

*Series 90-30 Installation and Hardware Manual, GFK-0356.*

*Series 90-30/20/Micro PLC CPU Instruction Set Reference Manual, GFK-0467*

*Series 90-30 System Manual, GFK-1411*

*CIMPLICITY® Machine Edition Getting Started, GFK-1868*



<b>Chapter 1</b>	<b>Overview and Specifications.....</b>	<b>1-1</b>
	Overview.....	1-1
	PROFIBUS Information.....	1-1
	IC693PBS201 Slave Module Specifications.....	1-3
	PROFIBUS Basics.....	1-4
	PROFIBUS Network Overview.....	1-4
	Bus Communication.....	1-4
	Network Topology.....	1-5
	Network Connectors.....	1-6
<b>Chapter 2</b>	<b>Installation .....</b>	<b>2-1</b>
	Reviewing System Power Requirements.....	2-1
	Installing the PROFIBUS Module in the PLC Rack.....	2-2
	Connecting the Slave to the PROFIBUS Network.....	2-2
	Network Segment Length.....	2-2
	PROFIBUS Cable Types.....	2-3
	Network Termination.....	2-4
	Network Baud Rate.....	2-5
	Removing the Module from the Rack.....	2-5
<b>Chapter 3</b>	<b>Configuration.....</b>	<b>3-1</b>
	Adding a PROFIBUS Slave Module to the Hardware Configuration.....	3-1
	Configuring a PROFIBUS Slave Module.....	3-3
	Parameters.....	3-3
	Settings Tab.....	3-3
	Input Data Area Tab.....	3-4
	Output Data Area Tab.....	3-5
	Power Consumption Tab.....	3-6
<b>Chapter 4</b>	<b>Status and Diagnostics .....</b>	<b>4-1</b>
	PROFIBUS Slave Module LED Indicators.....	4-2
	Communication Requests.....	4-3
	COMMREQ Ladder Instruction.....	4-3
	Operation of the Communications Request.....	4-4
	COMMREQ Programming Requirements and Recommendations.....	4-5
	Error Detection and Handling.....	4-5
	Corrective Actions for COMMREQ Errors.....	4-6
	COMMREQ Status Word.....	4-6
	PROFIBUS Slave Module COMMREQ Reference.....	4-7
	Get Slave Status COMMREQ (Command Code 3).....	4-8
	Memory Types.....	4-8
	Get Slave Status Command Block – Basic Example.....	4-8
	Get Slave Status - Reply Data Format.....	4-9
	Network Parameter Errors.....	4-10

# Contents

---

Read Module Header (5) .....	4-11
Read Module Header Command Block – Basic Example .....	4-11
Read Module Header Reply Data Format for Slave .....	4-13
Clear Counters (6) .....	4-14
Clear Counters Command Block – Basic Example .....	4-14
ClearCounters Reply Data Format .....	4-15

## Overview

The Series 90-30 PROFIBUS Slave module enables a Series 90-30 CPU to be a slave on a Profibus DP network and to communicate with a PROFIBUS DP master. It operates as a slave on the network, automatically exchanging data with a master device. The slave module has no bus access rights. It can only acknowledge received messages or transmit messages to a master upon request. Its features include:

- ability to read up to 244 bytes of input data from the network, and send up to 244 bytes of output data
- support for all standard PROFIBUS data rates
- PROFIBUS-compliant Module and Network Status LEDs
- an RS-232 serial port (the Service port) for upgrading the firmware

## PROFIBUS Information

Please refer to the following sources for PROFIBUS information:

- PROFIBUS standard DIN 19245 parts 1 (low-level protocol and electrical characteristics) and 3 (DP protocol)
- European standard EN 50170
- ET 200 Distributed I/O system, 6ES5 998-3ES22
- IEEE 518 Guide for the Installation of Electrical Equipment to Minimize Electrical Noise Input to Controllers



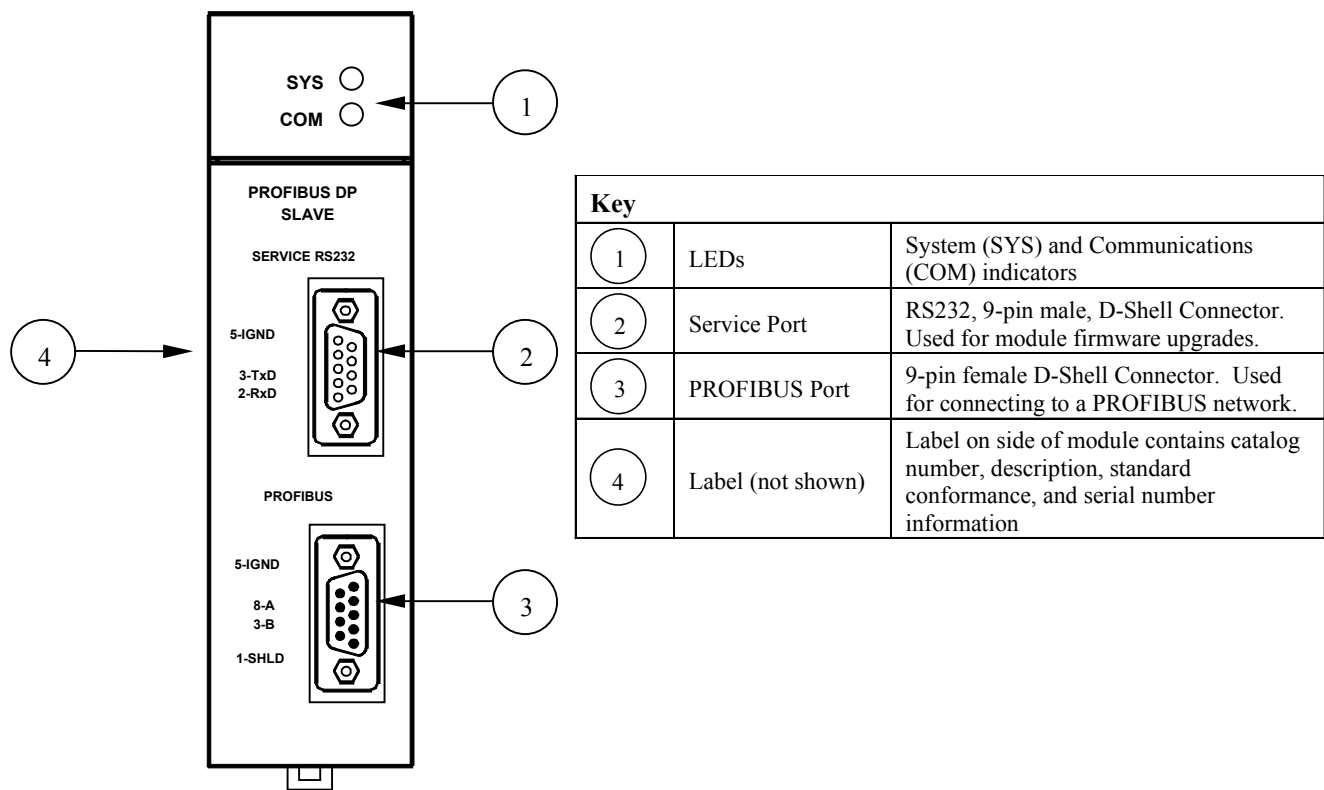

IC693PBS201  
PROFIBUS  
Slave Module

Figure 1-1. PROFIBUS Slave Module

## IC693PBS201 Slave Module Specifications

Catalog number	IC693PBS201
Description	Series 90-30 Slave module for PROFIBUS DP networks
Configuration software requirement	Requires CIMPLICITY Machine Edition Logic Developer version 2.6 or later
CPU version requirement	Requires CPU firmware version 8.00 or later
Mounting location	Can reside in any Series 90-30 baseplate (CPU, expansion, or remote) slot except for slot 1 of a modular CPU baseplate
Environment	Storage temperature = -40°C to 85°C Operating temperature = 0°C to 60°C
Backplane current consumption	450 mA at 5VDC (typical)
Data rates	Supports all standard Data Rates (9.6KBps, 19.2KBps, 93.75KBps, 187.5KBps, 500KBps, 1.5Mbps, 3MBps, 6MBps and 12MBps)
Status information available	<ul style="list-style-type: none"> <li>■ Slave Status Word</li> <li>■ Firmware module revision</li> </ul>

**Note:** The Profibus Slave module does *not* support Sync and Freeze modes

# PROFIBUS Basics

## PROFIBUS Network Overview

- PROFIBUS is an open, vendor independent FieldBus standard for a wide range of applications in industrial automation, including motion control.
- PROFIBUS is a dynamic technology that grows functionally while complying with the European FieldBus Standard EN 50 170.
- PROFIBUS Guidelines and Profiles provide the means for further technical development based on the ever-changing communication requirements of the networks, systems, and devices used in today's industrial automation applications.

PROFIBUS specifications reference three different protocols to cover a range of industrial requirements:

- *PROFIBUS-DP* High speed data communication. DP stands for *Decentralized Periphery*. In practice, the majority of slave applications are DP applications.
- *PROFIBUS-FMS* Object oriented general-purpose data communication. FMS stands for *FieldBus Message Specification*. FMS protocol devices may exchange data on the same bus used for DP devices.
- *PROFIBUS-PA* Meets requirements for intrinsic safety and non-intrinsic safety areas and includes bus powered field devices.

**Note:** The PROFIBUS logo is a registered trademark of the PROFIBUS International Organization. Membership in the organization is open to all individuals, companies and organizations. More information about the organization and the protocol is available at <http://www.profibus.com>

## Bus Communication

The PROFIBUS specification defines the technical characteristics of a serial field bus system that links distributed digital controllers on the network, from field level to cell level. PROFIBUS is a multi-master system that allows the joint operation of several automation, engineering or visualization systems with their distributed peripherals on one bus. PROFIBUS distinguishes between the following types of devices:

- **Master devices** determine the data communication on the bus. A master can send messages without an external request when it holds the bus access rights (the token). Masters are also called active stations.
- **Slave devices** include motion controllers, drives, I/O devices, valves, and transducers. Slaves do not have bus access rights and can only acknowledge received messages or send messages to the master when requested to do so. Slave devices are passive stations and require only small portions of the bus protocol.

The majority of PROFIBUS-DP applications are located at the field level. The field level typically includes slave devices such as the S2K motion controller station and host devices like PLC or PC control systems for the PROFIBUS-DP master station. Operator interfaces and DCS type systems usually operate at the cell level.

**Table 1-1. Data bandwidth Demands on PROFIBUS Communications Systems**

	<b>Amount of Data</b>	<b>Transmission Duration</b>	<b>Transmission Frequency</b>
Management level	Mbytes	Hours/Minutes	Day/Shift
Cell level	Kbytes	Seconds	Hours/Minutes
Field Level	Bytes	Several 100 microseconds to 100 milliseconds	10 to 100 milliseconds
Actuator sensor level	Bits	Microseconds to milliseconds	Milliseconds

## Network Topology

A PROFIBUS-DP network may have up to 127 stations (address 0-126), however address 126 is reserved for commissioning purposes. The bus system must be sub-divided into individual segments to handle this many participants. These segments are linked by repeaters. The function of a repeater is to condition the serial signal to allow connection of segments. In practice, both regenerating and non-regenerating repeaters may be used. Regenerating repeaters actually condition the signal to allow increased range of the bus. *Up to 32 stations are allowed per segment and the repeater counts as a station address.*

A specialized “link” segment consisting only of optical fiber modem repeaters may be used to span long distances. Plastic fiber optic segments are typically 50 meters or less while glass fiber, optic segments may extend several kilometers.

The user assigns a unique PROFIBUS station address to identify each master, slave, or repeater in the entire network. Each participant on the bus must have a unique station address.

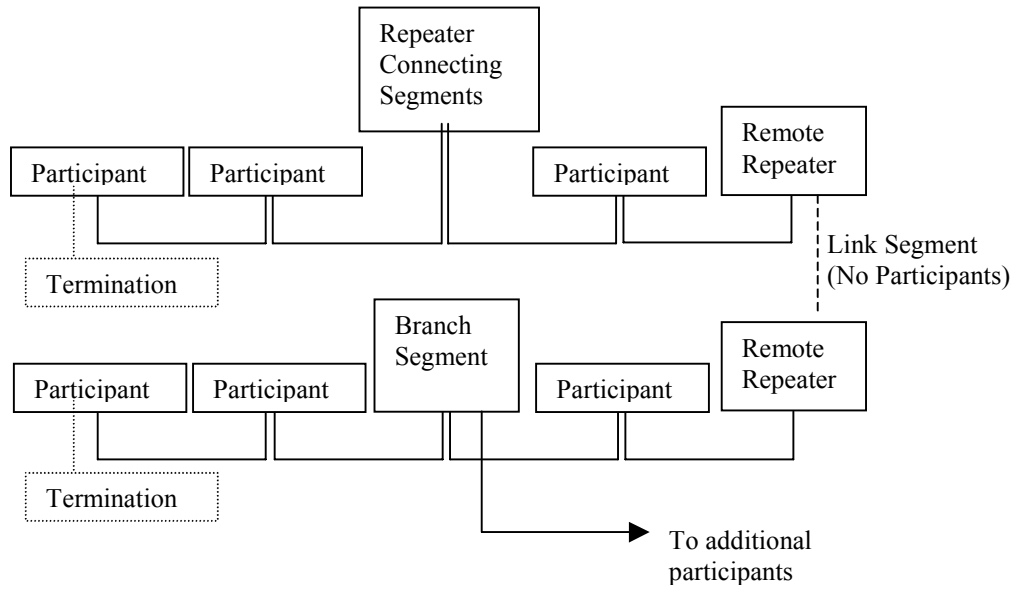

Figure 1-2. Repeaters and bus termination

## Network Connectors

PROFIBUS connections are created with a 9 pin sub-D connector. A minimum connection consists of a shielded twisted-pair cable (shield to pin 1 and twisted-pair wires to pins 3 and 8) with terminating connections in the appropriate bus plugs. The pin to signal conventions are described below.

Table 1-2. Pin-out Listing for the PROFIBUS Bus Plug Connector

Pin No.	Signal	Designation
1	Shield	Shield / Protective Ground
2	M24	Ground / Common of the 24V output voltage
3	RxD/TxD-P	Receive data / transmission data plus
4	CNTR-P	Control signal for repeaters (direction control)
5	DGND	Data transmission potential (ground to 5V)
6	VP	Supply voltage of the terminating resistance (+ 5V)
7	P24	Output voltage (+ 24V)
8	RxD/TxD-N	Receive data / transmission data negative
9	CNTR-N	Control signal for repeaters (direction control)

**Note:** For information on network segment length, network connectors and network termination, and network baud rate, refer to Chapter 2, “Installation.”

# Chapter 2

## Installation

---

---

This chapter contains information on the following procedures:

- Reviewing system power requirements
- Installing the PROFIBUS module in the PLC rack
- Installing PROFIBUS wiring
- Connecting the Slave to the PROFIBUS network
  - Selecting the proper line type
  - PROFIBUS cable types
  - Installing bus termination

### Reviewing System Power Requirements

Review the power requirements of your system to ensure that your power supply has sufficient capacity to support the PROFIBUS Slave module. Power supply load is automatically calculated by the CIMPLICITY Machine Edition configuration software. Details on manually calculating power supply load can be found in GFK-0356, the *Series 90-30 Installation and Hardware Manual*.

**Note:** High capacity Series 90-30 power supplies IC693PWR330 or IC693PWR331 are recommended, particularly for systems with CPU350 or higher, or that have Ethernet adapters and/or multiple PROFIBUS modules. The Series 90-30 PROFIBUS Slave module consumes 450mA at 5VDC (typical).

## Installing the PROFIBUS Module in the PLC Rack

1. Remove power from Series 90-30 rack.
2. Turn off power to rack.
3. Place the module into slot 1 or higher in the rack (slot 2 or higher in the Main rack) by hooking the top of the module on the notch above the slot and slowly lowering the module until it snaps into place.
4. Attach the PROFIBUS cable and terminate as required.

**Note:** For details about installing Series 90-30 rack systems and modules, refer to the *Series 90-30 Installation Manual and Hardware Manual*, GFK-0356.

## Connecting the Slave to the PROFIBUS Network

### Network Segment Length

A PROFIBUS network uses either fiber optic or RS-485 copper media. The copper bus line specified in EN 50 170 is “Line Type A” and is the recommended cable type. A more economical copper cable “Line Type B” is commonly used for smaller installations; however, it is not specified in EN 50 170. It is extremely important to use cable rated to PROFIBUS specifications. The higher the baud rate selected and the longer the distances involved, the more critical cable selection becomes. (PROFIBUS cable has a distinctive purple color.)

Stub or “T” type branch connections are supported if the total stub (branch) lengths do not exceed 6.6 meters. Do not use stubs at all on 12 Mbaud networks.

The data rates for network communication with maximum segment trunk length per cable type are provided below. Multiple segments may be connected via repeater stations to extend the total bus length.

**Table 2-1. Line Types**

Baud Rate	Line A Distance (Max) <sup>1, 2</sup>	Line B Distance (Max) <sup>1, 2</sup>	Glass Fiber
9.6KBps, 19.2KBps and 93.75KBps	1200 m	1200 m	6Km
187.5KBps	1000 m	600 m	6Km
500KBps	400 m	200 m	6Km
1.5MBps	200 m	NA	6Km
3, 6 and 12MBps	100 m	NA	6Km

<sup>1</sup> If using a combination of both line types, divide the lengths shown by two.

<sup>2</sup> Values shown are the sum of all bus segment and drop cable lengths. NA = Not Applicable

**Termination Note:** The two physical ends of the PROFIBUS network should be terminated. There should be two, and only two, terminators on a network.

---

## PROFIBUS Cable Types

The recommended cable is

- Belden 3079A PROFIBUS Cable.

This is a shielded, 150 ohm twinaxial (single twisted pair) cable. It has 22 AWG conductors and a mutual capacitance of 9.0 pF per foot, nominal. For complete specifications on this cable, please contact your Belden dealer or visit their website at [www.belden.com](http://www.belden.com).

Alternate cable types are:

- Siemens 6XV1 830-OAH10 Two Core shielded
- Siemens 6XV1 830-OBH10 w/PE Sheath
- Siemens 6XV1 830-3AH10 for underground burial
- Siemens 6XV1 830-3BH10 trailing cable
- Bosch Comnet DP #913 548 Flexible PROFIBUS cable
- Bosch Comnet DP #917 201 Trailing PROFIBUS Cable
- Bosch Comnet DP #917 202 Massive PROFIBUS Cable

**Note:** Allen Bradley “blue hose,” which has an impedance of *78 ohms*, is not recommended for this application.



## Network Termination

Termination resistors are needed, as defined in DIN 19245 Part 1 section 3.1.2.5.

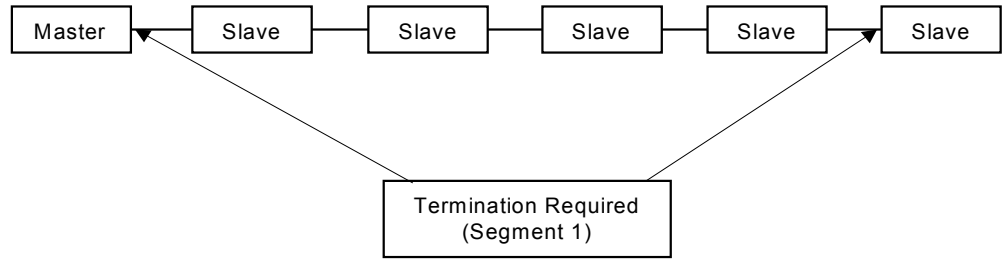

One terminator must be applied at each end of a network segment.

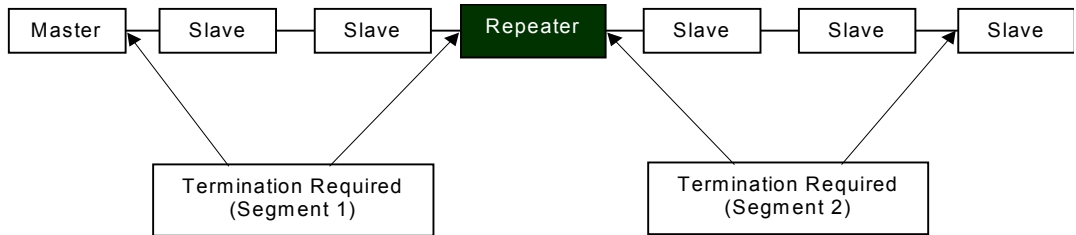

Generally, termination is provided in commercially-available PROFIBUS standard network connectors. Some connector vendors provide termination capability in the connector and a switch on the connector to enable/disable termination. Some connector vendors provide both terminated and unterminated connectors.

**Important:** For proper network termination, it is essential that the terminating devices maintain power. Power is provided by the device on Pin 6 and Ground on Pin 5. If power is lost to either terminating device, the network may not operate correctly. Generally, the lone network master device is one of the terminating devices. Therefore, a loss of power to the network master renders the network inoperable anyway. The other terminating device may be a critical slave device, which must maintain power, or a separately powered, stand-alone terminator. These stand-alone devices are commercially available.

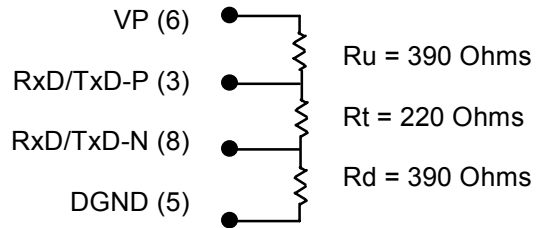
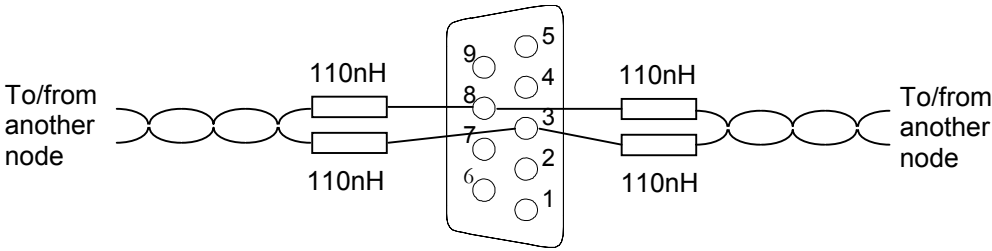

Figure 2-1. Bus Termination for Type A Cable in Accordance to PROFIBUS Specifications

In addition to the termination shown above, the following compensation should be added for 12 Mbit bus technology:



### Network Baud Rate

The master configures the appropriate network baud rate for each station on the network. Typical baud rate values are: 9.6KBps; 19.2KBps; 45.45KBps; 93.75KBps; 187.5KBps; 500KBps; 1.5MBps; 3MBps; 6MBps; or 12MBps. For details on using the configuration software, refer to chapter 3.

### Removing the Module from the Rack

The following procedure describes how to remove the GE Fanuc Series 90-30 master:

1. Turn off power to rack.
2. Remove all cabling from the module.
3. Press the release located on the bottom of the module and slowly raise the module from the bottom until it comes out of the slot.

# Chapter 3



## Configuration

These configuration procedures are intended for users with at least a basic knowledge of the CIMPLICITY Machine Edition Logic Developer software and the Series 90-30 PLC. For help with using the software, please see the software's built-in help system.

**Note:** The PROFIBUS Slave is supported only in CIMPLICITY Machine Edition Logic Developer. The following packages do not support the PROFIBUS Slave: LogiMaster™, VersaPro™, and Control software.

### Adding a PROFIBUS Slave Module to the Hardware Configuration

Add the IC693PBS201 module to the PLC rack configuration.

1. In the  Project tab of the Navigator,  expand the  Hardware Configuration folder.
2. In the Hardware Configuration folder, right click the PLC Slot where you wish to install the PROFIBUS Slave module. Note that a PROFIBUS module is not a valid choice for slot 1 of a modular CPU rack.

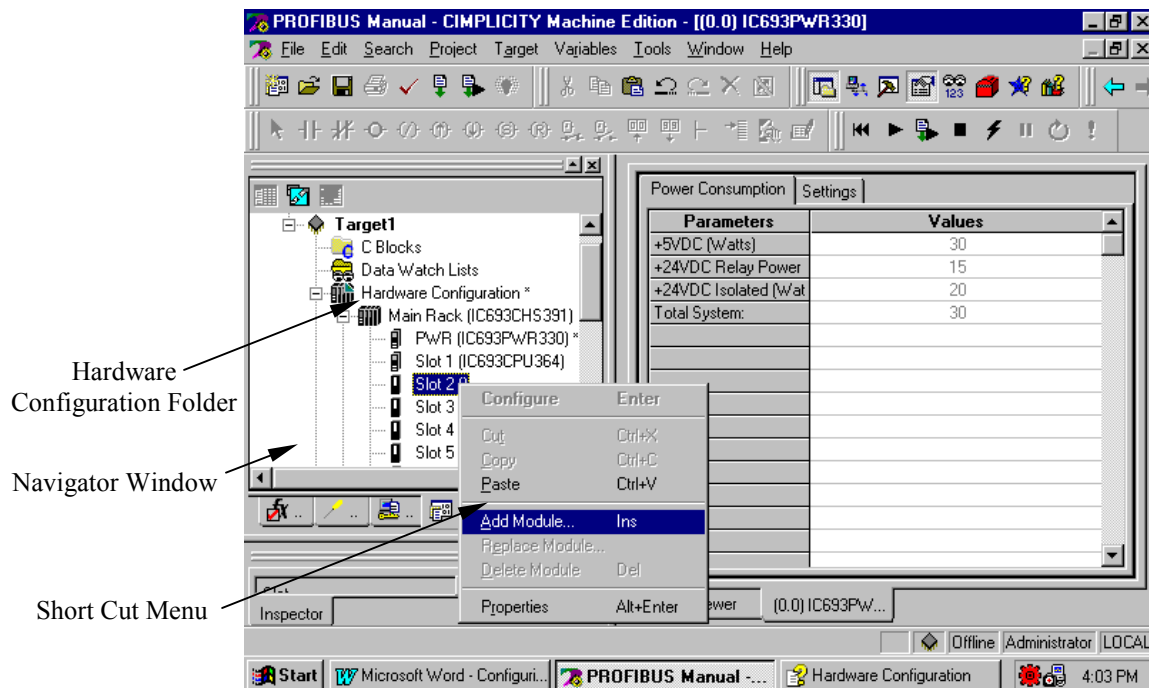

Figure 3-1. Adding a Module

3. Select Add Module from the shortcut menu. The Module Catalog dialog box appears.
  - Note:** To edit a module that already appears in the rack, right click the module and select Configure. The module's Parameter Editor window opens.
4. Click the Communications tab. The Communications module list appears.

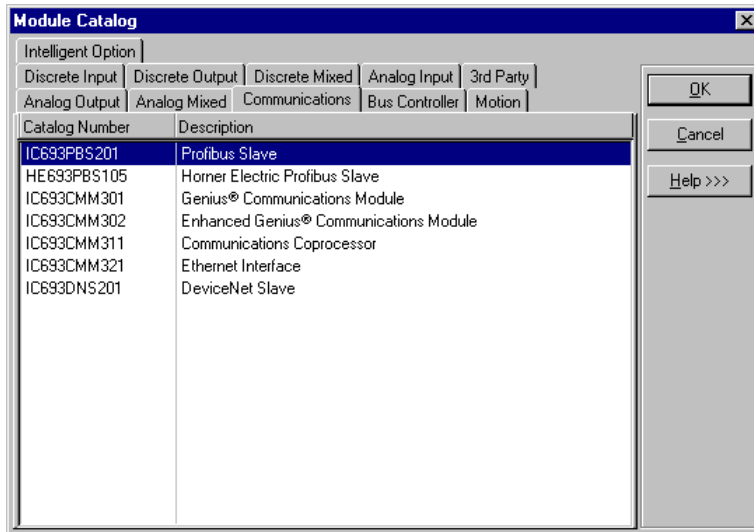

Figure 3-2. Module Catalog Window's Communications Tab

5. Select the IC693PBS201 PROFIBUS Slave and click the OK button. The module is added to the PLC configuration in the Navigator window, and the module's Parameter Editor window appears in the InfoViewer window space.

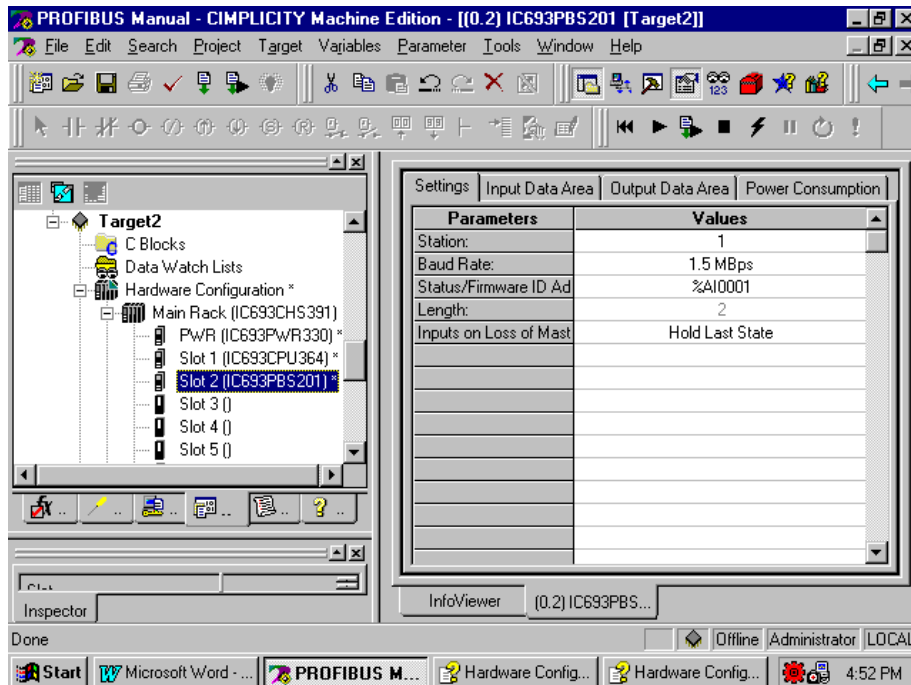

Figure 3-3. PROFIBUS Slave Module's Parameter Editor Window

# Configuring a PROFIBUS Slave Module

The PROFIBUS Slave module has four tabs: Settings, Input Data Area, Output Data Area, and Power Consumption.

## Parameters

- To edit a parameter, double click its value field in the Parameter Editor window.

## Settings Tab

<b>Station</b>	The Slave module's station number that is used on the PROFIBUS network. Can be in the range from 1 to 125. Each module on a network should be given a <i>unique</i> station number. Default is 1. Note that the Master is commonly assigned to Station 0 (zero).
<b>Baud Rate</b>	Specifies the data transmission rate for the PROFIBUS Slave module in bits/second (bps). Values: 9.6Kbps, 19.2KBps, 93.75KBps, 187.5KBps, 500KBps, 1.5MBps, 3MBps, 6Mbps, 12MBps Default: 1.5MBps <b>Note:</b> The Horner PROFIBUS Slave module, HE693PBS105, does not have this setting. If you are converting from a Horner module to a Series 90-30 IC693PBS201 PROFIBUS Slave module, you will need to set this parameter.
<b>Status/Firmware ID Address</b>	This is the starting address for this two-word array. Status/Firmware ID Address is a consumed range and as such must be a non-overlapping range in %AI, %I, %Q, %G, %AQ, %R, %T, or %M. Defaults to %AI memory.  The Status word provides information about the status of the PBS201 module to the PLC CPU. For more information, see "Get Slave Status Reply Data Format" in chapter 4.  The Firmware ID word contains the current firmware version running on the PBS201. The Major Revision number resides in the upper byte and the Minor Revision number resides in the lower byte of this word.  <b>Tip:</b> Use the Communication Request (COMMREQ) task 3 (GetSlaveStatus) to retrieve the information that is reported in this memory area. (This COMMREQ is sent from the CPU of the PLC where the Slave module resides.)
<b>Length</b>	Always two words. (A value of 2 for register memories and 32 for discrete memories.)
<b>Inputs on Loss of Master</b>	Determines what values are used for the data received by the module from the master (inputs to the Slave module/outputs from the master) if communication with the master is lost. Choices are:  Hold Last State (default) – Until communication resumes and new values are received, each input will have the value that it had when communication was lost.  Clear – Until communication resumes and new values are received, each input will have a value of 0.

### Input Data Area Tab

The input data area describes data received over the network by the Slave module from the PROFIBUS Master. These inputs are mapped, using the Input Data Area tab, into specific memory locations in the PLC where the Slave module resides.

Area	Type	Size	Units	Ref Address	Length
1	Digital In	1	Byte	%I00081	8
2	Digital In	1	Byte	%I00089	8
3	Analog In	1	Word	%AI0001	1
4	Analog In	1	Word	%AI0005	1
5	Empty	0	Byte	%I00001	0
6	Empty	0	Byte	%I00001	0
7	Empty	0	Byte	%I00001	0
8	Empty	0	Byte	%I00001	0
9	Empty	0	Byte	%I00001	0
10	Empty	0	Byte	%I00001	0
11	Empty	0	Byte	%I00001	0

Table 3-1. PROFIBUS Slave Module’s Input Data Area Parameters

<b>Area</b>	A read-only identifier for the row. Valid range: 1 to 32.
<b>Type</b>	Data type of area being defined. Valid types are Digital In, Analog In, and Empty. The default value is Empty.
<b>Size</b>	Describes the size of the data area on the network. Set to 0 and read-only if Type is set to Empty. Valid ranges: If Type is set to Analog In (Word): 1—122 If Type is set to Digital In (Byte): 1—244
<b>Notes:</b>	The total number of input bytes for all entries cannot exceed 244. A value of 0 sets Type to Empty.
<b>Units</b>	This read-only field gives the units for the Type specified. If Type is set to Empty or Digital In: Byte If Type is set to Analog In: Word
<b>Ref Address</b>	Location in PLC memory where the received data is mapped. This field is read-only if Size is set to 0. This is a consumed range and must be a non-overlapping range in %AI, %I, %Q, %G, %AQ, %R, %T or %M. If Type is set to Digital In and the number of bytes (Size) is odd, an address in discrete memory must be used: %I, %Q, %G, %M, or %T. Default: For Digital In, next available address in %I For Analog In, next available address in %AI
<b>Length</b>	The length of the reference mapped to the area. Allowable ranges: For discrete memories (in bits), 0, 8, 16 ... X For register memories (in words), 0, 1, 2 ... X where X is the required length to hold the entire data area. The default value is the space required to map bytes specified by the entries in Type and Size.
<b>Note:</b>	If an input data area is defined (Type and Size are specified) but Length is set to 0, data received by the Slave is ignored.

## Output Data Area Tab

The output data area describes data sent over the network by the Slave module to the PROFIBUS Master. These outputs are mapped, using the Output Data Area tab, from specific memory locations in the PLC where the Slave module resides.

Area	Type	Size	Units	Ref Address	Length
1	Digital Out	1	Byte	%Q00001	8
2	Digital Out	1	Byte	%Q00009	8
3	Analog Out	1	Word	%AQ0001	1
4	Analog Out	1	Word	%AQ0002	1
5	Empty	0	Byte	%Q00001	0
6	Empty	0	Byte	%Q00001	0
7	Empty	0	Byte	%Q00001	0
8	Empty	0	Byte	%Q00001	0
9	Empty	0	Byte	%Q00001	0
10	Empty	0	Byte	%Q00001	0
11	Empty	0	Byte	%Q00001	0

Table 3-2. PROFIBUS Slave Module's Output Data Area Parameters

<b>Area</b>	Read-only identifier for the row. Valid range: 1-32.
<b>Type</b>	Data type of area being defined. Valid types are Digital Out, Analog Out, and Empty. The default value is Empty.
<b>Size</b>	Describes the size of the data area on the network. Set to 0 and read-only if Type is set to Empty. Valid ranges: If Type is set to Digital Out (Byte): 0—244 If Type is set to Analog Out (Word): 0—122
<b>Note:</b>	The total number of output bytes for all entries cannot exceed 244.
<b>Units</b>	This read-only field gives the units for the Type specified. If Type is set to Empty or Digital Out: Byte If Type is set to Analog Out: Word
<b>Ref Address</b>	Location in PLC memory where the data to be sent is mapped. This field is read-only if Size is set to 0. This is a produced range and can be any range in %AI, %I, %Q, %G, %AQ, %R, %T, or %M. If Type is Digital Out and the number of bytes (Size) is odd, an address in discrete memory must be used: %I, %Q, %G, %M, or %T. Overlaps with another produced range are not considered fatal and can be included in a valid configuration. Default: For Digital Out, next available address in %Q For Analog Out, next available address in %AQ
<b>Length</b>	The length of the reference mapped to the area. Allowable ranges: For discrete memories: 0, 8, 16 ... X For register memories: 0, 1, 2 ... X where X is the required length to hold the entire data area. The default value is the space required to map bytes specified by the entries in Type and Size.
<b>Note:</b>	If an output data area is defined (Type and Size are specified) but Length is set to 0, a value of 0 is sent to the Master for that data area.

---

## Power Consumption Tab

The information in this tab is read-only. It displays the power consumed by the module from the PLC backplane.



There are two methods for obtaining status and diagnostic data:

- Observing and interpreting the LED indicators on the PROFIBUS module
- Using Communications Request (COMMREQ) ladder logic instructions to instruct the PROFIBUS module to gather diagnostic or status data and report it to the PLC CPU.

**Note:** The Profibus Slave Modules does not generate faults for the Fault Table.

This chapter is divided into two sections:

- PROFIBUS Module LED Indicators, page 4-2
- Communication Requests, page 4-3

## PROFIBUS Slave Module LED Indicators

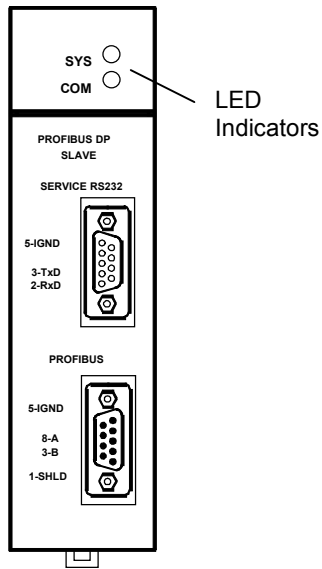

SYS LED	
Color	Indication
Red	The Slave is not being scanned or is faulted.
Amber	The Slave is being scanned in <i>Stop</i> mode.
Green	The Slave is being scanned in <i>Run</i> mode.
Flashing Green	This LED flashes green for two seconds at system startup
Off	Profibus Slave is not configured

COM LED
The PROFIBUS slave does not use the COM LED, except when loading firmware. This LED is normally off.
Flashing Green – Profibus Slave is not configured

**Note:** When loading firmware, the module is placed in the *System Configuration* mode. When in this mode, the COM and SYS LEDs flash red alternately.

# Communication Requests

The Communications Request uses the parameters of the *COMMREQ Ladder Instruction* and an associated *Command Block* to define the characteristics of the request. An associated *Status Word* reports the results of each request.

The Communication Request function (COMMREQ) allows the program to communicate with a GE Fanuc intelligent module, such as a PROFIBUS slave module.

The COMMREQ function uses a *command block* that contains the data to be communicated to the other device, plus information related to the execution of the COMMREQ. The command block must be placed in the designated memory area using data move instructions, such as MOVE or BLKMOV (Block Move).

The CPU reports the result of the COMMREQ in the *status word*, which is a single location in PLC data memory. The status word address is specified in the command block. For a list of status codes reported in the status word, see “COMMREQ Status Word” on page 4-6.

The PROFIBUS slave module supports one COMMREQ, described on page 4-7.

## COMMREQ Ladder Instruction

This discussion provides an overview of the COMMREQ instruction. For details of the COMMREQ ladder instruction, refer to the online help provided with the programming software. The Communications Request begins when the COMMREQ Ladder Instruction is activated. The COMMREQ ladder instruction has four inputs and one output:

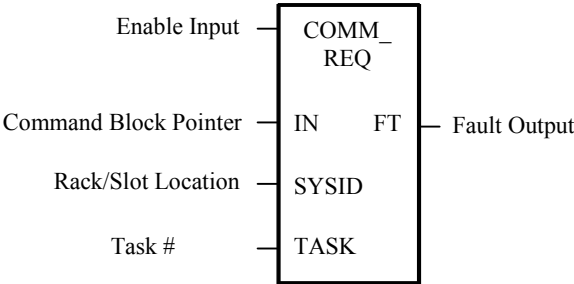

Figure 4-1. COMMREQ Ladder Instruction

**Enable Input:** Must be Logic 1 to enable the COMMREQ Instruction. It is recommended that the enabling logic be a contact from a transition (“one-shot”) coil.

**IN:** The memory location of the first word of the Command Block. It can be any valid address in word-type memory (%R, %AI, or %AQ). For example, %R00100 at IN would indicate that the starting address of the Command Block is %R00100.

**SYSID:** The rack and slot location of the module that the COMMREQ is targeting. The high byte contains the rack number, and the low byte contains the slot number. The table below shows some examples of SYSIDs:

SYSID Examples		
Rack	Slot	Word Value
0	4	0004
3	4	0304
2	9	0209

**TASK:** Must be set to 1.

**FT Output:** The function's FT (fault) output can provide an output to optional logic that can verify successful completion of the Communications Request. The FT output can have these states:

FT Output Truth Table		
Enable Input Status	Does an Error Exist?	FT output
Active	No	Low
Active	Yes	High
Not active	No execution	Low

- The FT output is set High if:
  - The specified target address is not present (for example, specifying Rack 1 when the system only uses Rack 0).
  - The specified task number is not valid for the device.
  - Data length is set to 0.
- The FT output can either be connected to another device, such as a set coil, or can be left open.

## Operation of the Communications Request

The figure below illustrates the flow of information between the PLC CPU and the PROFIBUS Slave module:

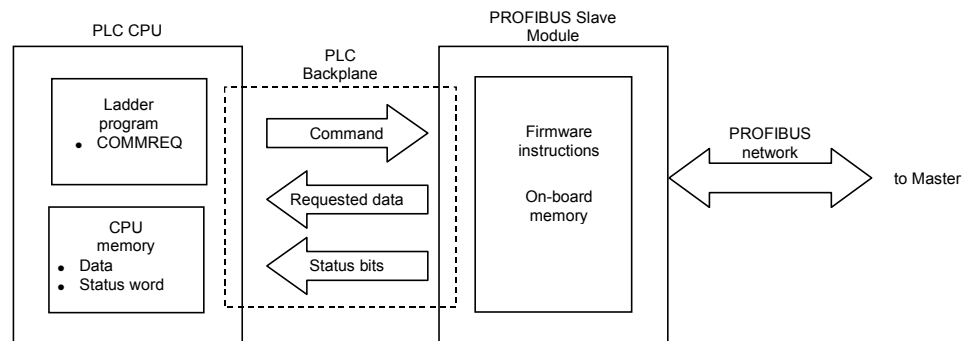

**Figure 4-2. Operation of the PROFIBUS Communications Request**

A Communications Request is initiated when a COMMREQ ladder instruction is activated during the PLC scan. At this time, a command from the PLC via the Communications Request is sent to the PROFIBUS Master module (PBM).

At the conclusion of every request, the PLC CPU reports the status of the request to the Status Word, which is a location in PLC memory that is designated by the Status Word Pointer in the Command Block.

In Figure 4-2, the PBM is shown in the CPU rack and communications occur over the PLC backplane. If the PBM is located in an expansion or remote rack, the commands and data are sent over the CPU rack's backplane, through the expansion or remote cable to the rack containing the PBM, and across that rack's backplane to the PBM.

## COMMREQ Programming Requirements and Recommendations

- COMMREQ instructions should be enabled by a contact from a transition coil.
- If using more than one COMMREQ in a ladder program, verify that a previous COMMREQ executed successfully before executing another one. This can be done by checking the Status Word and the FT (Fault) output.
- The FT output is held False if the Enable Input is not active. This means that if the COMMREQ is enabled by a transitional (one-shot) contact and a fault occurs, the FT output is High for only one PLC scan. To capture the fact that a fault occurred, you can program the fault output as a Set coil, which would not be automatically reset at the end of a scan. Additional logic would then be needed to reset the fault output coil after the fault is acknowledged and before the next execution of the COMMREQ.
- Programming a device, such as a Set Coil, on the FT output of the COMMREQ is optional; this output may be left open if desired.
- It is necessary to initialize the data in the Command Block before executing the COMMREQ instruction. Since the normal PLC sweep order is from top to bottom, initializing the Command Block in an earlier rung (or rungs) than the rung that contains the COMMREQ will satisfy this requirement.

## Error Detection and Handling

As shown in “COMMREQ Status Word”, a value of 1 is returned to the Status Word if communications proceed normally, but if any error condition is detected, a value greater than 1 is returned. If you require error detection in your ladder program, you can use a Greater Than (GT) compare instruction to determine if the value in the Status Word is negative (less than zero). If an error occurs, the GT instruction's output (Q) will go high. A coil driven by the output can be used to enable fault handling or error reporting logic.

The FT output of the COMMREQ, described on page 4-4, goes high for certain faults and can be used for fault detection also. Additionally, the first Status Word can be monitored by error message logic for display on an Operator Interface device, in which case, Status Word codes would correspond to appropriate error messages that would display on the operator screen.

To dynamically check the Status Word, write a non-significant positive number (0 or 99 are typically used) into the Status Word each time before its associated COMMREQ is executed. If the

instruction executes successfully, the CPU will write the number 1 there. This method lets you know that if the number 1 is present, the last COMMREQ executed successfully, and that the 1 was not just left over from a previous execution.

When multiple COMMREQs are used, it is recommended that each be verified for successful communications before the next is enabled. Monitoring the Status Word is one way to accomplish this.

### Corrective Actions for COMMREQ Errors

The type of corrective action to take depends upon the application. If an error occurs during the startup or debugging stage of ladder development, you should verify the COMMREQ parameters. The same is true if an error occurs right after a program is modified. But, if an error occurs in a proven application that has been running successfully, the problem is more likely to be hardware-related. The PLC fault tables should be checked for possible additional information when troubleshooting Status Word errors.

### COMMREQ Status Word

The following table defines the format of the Status Block used during the COMMREQ handshake.

**Table 4-1. Status Word Format**

Word	Name	Description
1	State (see table 4-2)	The state of the current COMMREQ request
2	LostCommand	Command code of the last command lost when the CRL bit is set in Flags.
3	ErrorCode	Not Used
4	AdditionalCode	Additional code for error reporting

**Table 4-2. Status Word State Codes**

Value	Description
0	Module has not yet processed the COMMREQ
1	Command Complete <b>Note:</b> This status does not necessarily mean success. Some commands have reply data that must also be checked.
2	Command Terminated – module busy
3	Command Terminated – invalid command
4	Command Terminated – invalid command data
5	Command Terminated – not enough data
6	Command Terminated – command collision An identical command, which has already reported completion, is currently being processed and has not replied yet.
7	Command Terminated – not enough memory in reply area The command did not specify sufficient PLC memory for the reply. Command will be ignored.
8	Command Terminated – command-specific error. See ErrorCode and AdditionalCode in the Status Block for more information.
9–255	Reserved

---

## PROFIBUS Slave Module COMMREQ Reference

The PROFIBUS Slave module supports the following COMMREQ tasks and responses.

**Table 4-3. PROFIBUS Slave COMMREQs**

<b>Task</b>	<b>Name</b>	<b>Description</b>	<b>Page No.</b>
3	Get Slave Status	Retrieves detailed status information for the Slave.	4-8
5	Read Module Header	Retrieves module header information.	4-11
6	Clear Counters	Clears counters in ReadModuleHeader	4-14

## Get Slave Status COMMREQ (Command Code 3)

The Get Slave Status COMMREQ retrieves detailed status information for the slave module from the 16-bit slave status word. The starting address of this word is configured as Status/Firmware ID Address in the PROFIBUS Slave module software configuration. For details, refer to “Parameters” in chapter 3.

### Memory Types

The following table lists the memory types that can be used for the Status Block and Reply Data areas.

**Table 4-4. COMMREQ Status Word Memory Type Codes**

Memory Type Abbreviation	Memory Type	Decimal code to enter
%I	Discrete input table (BYTE mode)	16
%Q	Discrete output table (BYTE mode)	18
%R	Register memory	8
%AI	Analog input table	10
%AQ	Analog output table	12
%T	Discrete temporary memory (BYTE)	20
%M	Discrete internal memory (BYTE)	22

### Get Slave Status Command Block – Basic Example

Get Slave status for Device

Return the COMMREQ status words to %R10—%R13.

Return the Slave status to %R251-%R259.

Word	Dec (Hex)	Definition
Word 1	00004 (0004)	Length of command Data Block
Word 2	00000 (0000)	Always 0 (no-wait mode request)
Word 3	00008 (0008)	Memory type of COMMREQ status word (%R)
Word 4	00009 (0009)	COMMREQ status word address minus 1 (%R10)*
Word 5	00000 (0000)	Reserved
Word 6	00000 (0000)	Reserved
Word 7	00003 (0003)	Get Module Status command code.
Word 8	00008 (0008)	Memory type to write response (%R)
Word 9	00250 (00FA)	Starting Address to write response (response written to %R251)
Word 10	00005 (0005)	Maximum size of response area Must be 2 words or more, or an error will be reported in the COMMREQ status and the Get Slave Status request will be ignored.



**(Word 7) Command Code:** Word 7 specifies the Command code for the COMMREQ to be executed . Get Slave Status = 3

**(Word 8) Local PLC - Memory Type:** Words 8—9 specify the location in the PLC where the response will be written. Valid values for Word 8 are listed on page 4-8.

**(Word 9) Local PLC - Memory Starting Address:** Word 9 determines the starting address in the local PLC in which the response is to be written. The value entered is the offset (0-based) from the beginning of PLC memory for the memory type and mode specified in Word 8. This offset will be either in bits, bytes, or words depending on the mode specified (for example, if Word 8=16 and Word 9=2, the starting address will be %I9). Valid ranges of values depend on the PLC’s memory ranges.

**(Word 10) Response Memory Size:** Words 10 specifies the size of the memory block for the response. (Must be at least 2 words.)

### Get Slave Status - Reply Data Format

Word	Name	Description
Word 1	CommandCode	Echo of Command code that this data block is replying to. (0x0003)
Word 2	StatusCode	See Word 2 formats in table below
Word 3—10	Reserved for Future Use	Word 10 of the command block should specify a minimum of 5 words to accommodate possible future use of this space.

**Note:** The reply from Get Slave Status contains the same information that is provided to the PLC CPU in the Status/Firmware ID Address. This parameter is defined when the module is configured in the PLC hardware configuration.

#### Word 2 – Status Code

Bit	Meaning	Value
0—6	Error Info	See “Network Parameter Errors” below
7	Run/Stop	0=Stop, 1=Run This is the State of the Profibus Module, it is not the status of the PLC CPU. If the SYS LED is Green the bit=1, if the SYS LED is Red or Amber the bit=0
8	PLC Cfg	0= Module config from PLC CPU is Bad 1=Module config from PLC CPU is good
9	On-line	1=Online module firmware is running
10—11	Module State	0=Module is waiting for parameters from Master 1=Module is waiting for config from Master 2=Data Exchange is occurring – normal operation 3=Error either config error or module watchdog timeout
12—15	Baud Rate (bps)	0=12MBps, 1=6MBps, 2=3MBps, 3=1.5MBps, 4=500KBps, 5=187.5KBps, 6=93.75Bps, 8=19.2KBps, 9=9.6KBps

## Network Parameter Errors

The following errors codes may be returned in bits 0—7 in the Get Slave Status reply.

**Note:** The error code is the numerical value of the bits

Error Code	Meaning
0	No error
1	ID from master does not match Slave ID
2	Ready Time from Master does not match Slave Ready time
3	Master is requesting Freeze or Sync, which is not supported by the slave
4	Length of data from master to slave is incorrect
5	Length of data from slave to master is incorrect
6	One of the watchdog factors (SlvWdFact1 or SlvWdFact2) from the master was 0.
7	Slave watchdog time out (check response timeout)
8	Slave timeout watchdog disabled from master

## Read Module Header (5)

The Read Module Header command retrieves Network Diagnostic Information for the Device.

### Read Module Header Command Block – Basic Example

The following command block accomplishes the following:

Get Module Header Data  
 Return the COMMREQ Status Word to %R10—%R13.  
 Return the Device Status to %R251—%R275.

Word	Dec (Hex)	Definition
Word 1	00004 (0004)	Length of command Data Block
Word 2	00000 (0000)	Always 0 (no-wait mode request)
Word 3	00008 (0008)	Memory type of COMMREQ status word (%R)
Word 4	00009 (0009)	COMMREQ status word address minus 1 (%R10)
Word 5	00000 (0000)	Reserved
Word 6	00000 (0000)	Reserved
Word 7	00005 (0005)	Read Module Header command number
Word 8	00008 (0008)	Memory type to write response (%R)
Word 9	00250 (00FA)	Starting Address to write response(response written to %R251)
Word 10	000025 (0019)	Size of response area, 25 for slave

**(Word 7) Command Code:** Word 7 specifies the Command code for the COMMREQ to be executed . Read Module Header = 5

**(Word 8) Local PLC - Memory Type:** Words 8—9 specify the location in the PLC where the response will be written. Valid values for Word 8 are listed below:

Type	Value (Decimal)	Description
%R	8	Register memory (word mode)
%AI	10	Analog input memory (word mode)
%AQ	12	Analog output memory (word mode)
%I	16	Discrete input memory (byte mode)
%Q	18	Discrete output memory (byte mode)
%T	20	Discrete temporary memory (byte mode)
%M	22	Discrete momentary internal memory (byte mode)

---

**(Word 9) Local PLC - Memory Starting Address:** Word 9 determines the starting address in the local PLC in which the response is to be written. The value entered is the offset (0-based) from the beginning of PLC memory for the memory type and mode specified in Word 8. This offset will be either in bits, bytes, or words depending on the mode specified (for example, if Word 8=16 and Word 9=2, the starting address will be %I9). Valid ranges of values depend on the PLC's memory ranges.

**(Word 10) Response Memory Size:** Word 10 specifies the size of the memory block for the response. The Response Memory Size is 25 words. If the Response Memory Size is set smaller than 25, the COMMREQ will fail with a 7 in the COMMREQ Status Word. The user is responsible for assuring that this area is large enough to contain the requested data without overwriting other application data

## Read Module Header Reply Data Format for Slave

Word	Name	Description
Word 1	Command Code	Echo of the Command Code that this data block is replying to (0x0005).
Word 2	ModuleType	Contains 1 if the module is a Slave and a 2 if the module is a Master.
Word 3	PfbStatus	PROFIBUS Status register, also can be read using the Get Device Status COMMREQ. For definitions, see page 4-9.
Word 4	ModuleVersion	Module firmware version. 0122h = 1.22
Word 5	ErrLanOffline	Counter. LAN went offline due to errors.
Word 6	DiagConf	Total confirmations.
Word 7	DiagInd	Total indications.
Word 8	ErrNotOk	Total not OK confirmations and indications.
Word 9	DiagSlaveUpdate	Number of updates the Slave has received from the Master
Word 10	ErrSlvErr	Count of Slave Configuration Errors
Word 11	ErrSlvTout	Count of Slave Watchdog timeouts (update not received in time)
Word 9	ErrInvReqLen	Invalid request length error counter.
Word 10	ErrFifo	FIFO overflow error counter.
Word 11	ErrRxOverun	Receive overrun error counter.
Word 12	ErrDbI Tok	Double token error counter.
Word 13	ErrRespErr	Response error counter.
Word 14	ErrSynErr	General network error counter.
Word 15	ErrNetTout	Network timeout error counter.
Word 16	ErrHsa	Station higher than HAS was heard counter.
Word 17	ErrStn	Duplicate station detected counter.
Word 18	ErrPasTok	Unable to pass token counter.
Word 19	ErrLasBad	Active station list is invalid.
Word 20	ErrInternal	Internal errors.
Word 21	ErrArg	Argument errors.
Word 22	ErrEventOverun	A new event occurred before the last one was cleared.

**Note:** If the Name starts with Err the value stops at the maximum. If the Name starts with Diag the count rolls over to zero.

## Clear Counters (6)

The Clear Counters Command sets the counters in the PROFIBUS module to zero.

### Clear Counters Command Block – Basic Example

In the following command block, Status is returned in %R251—%R252 (words 8 and 9).

Word	Dec (Hex)	Definition
Word 1	00004 (0004)	Length of command Data Block
Word 2	00000 (0000)	Always 0 (no-wait mode request)
Word 3	00008 (0008)	Memory type of COMMREQ status word (%R)
Word 4	00009 (0009)	COMMREQ status word address minus 1 (%R10)
Word 5	00000 (0000)	Reserved
Word 6	00000 (0000)	Reserved
Word 7	00006 (0006)	Clear Counters command number
Word 8	00008 (0008)	Memory type to write response (%R)
Word 9	00250 (00FA)	Starting Address to write response(response written to %R251)
Word 10	00002 (0002)	Maximum size of response area

**(Word 7) Command Code:** Word 7 specifies the Command code for the COMMREQ to be executed . Clear Counters = 6

**(Word 8) Local PLC - Memory Type:** Words 8—9 specify the location in the PLC where the response will be written. Valid values for Word 8 are listed below

Type	Value (Decimal)	Description
%R	8	Register memory (word mode)
%AI	10	Analog input memory (word mode)
%AQ	12	Analog output memory (word mode)
%I	16	Discrete input memory (byte mode)
%Q	18	Discrete output memory (byte mode)
%T	20	Discrete temporary memory (byte mode)
%M	22	Discrete momentary internal memory (byte mode)

**(Word 9) Local PLC - Memory Starting Address:** Word 9 determines the starting address in the local PLC in which the response is to be written. The value entered is the offset (0-based) from the beginning of PLC memory for the memory type and mode specified in Word 8. This offset will be either in bits, bytes, or words depending on the mode specified (for example, if Word 8=16 and Word 9=2, then the starting address will be %I9). Valid ranges of values depend on the PLC's memory ranges.

**(Word 10) Response Memory Size:** Words 10 specifies the size of the memory block for the response. The Response Memory Size is 2 words. If the Response Memory Size (word 10 in the Clear Counters command block) is set greater than 2, the COMMREQ will succeed. The unneeded memory locations are not written.

---

## ClearCounters Reply Data Format

Word	Name	Description
Word 1	CommandCode	Echo of Command code that this data block is replying to. (0x0006)
Word 2	StatusCode	Reports 1 for success and 0 for failure.

## C

- Clear Counters (6), 4-14
- COMMREQs
  - Clear Counters (6), 4-14
  - Get Slave Status
    - details, 4-8
    - memory types, 4-8
  - PROFIBUS Master, 4-7
  - Read Module Header (5), 4-11
- COMMREQs, general information, 4-3
  - error detection and handling, 4-5
  - ladder instruction, 4-3
  - operation, 4-4
  - programming recommendations, 4-5
  - status word, 4-6
- Configuration, 3-1
  - software, 1-3
- CPU version, 1-3

## F

- Features, 1-3

## G

- Get Slave Status
  - details, 4-8
  - memory types, 4-8

## I

- Installation procedures
  - installing bus termination, 2-4
  - installing the module in the rack, 2-2
  - reviewing system power requirements, 2-1

## L

- LED indicators, 4-2

## M

- Mounting location, 1-3

## O

- Overview, 1-1

## P

- Pin-out
  - PROFIBUS bus plug connector, 1-6
- Power consumption, 1-3

- Power supplies, 2-1

## PROFIBUS

- baud rate, 2-5
- bus communication, 1-4
- network connectors, 1-6
- network overview, 1-4
- network topology, 1-5
- standards, 1-1

## R

- Read Module Header, 4-11
- Reviewing system power requirements, 2-1

## S

- Selecting the proper line type, 2-2
- Specifications, 1-3
  - environment, 1-3
  - power consumption, 1-3
- Standards
  - PROFIBUS, 1-1
- Status and diagnostic methods, 4-1
- Status information, 1-3
- Status Word codes, 4-6