

GFK-0827

[Buy GE Fanuc Series 90-30 NOW!](#)

GE Fanuc Manual Series 90-30

Hot Standby CPU Redundancy

1-800-360-6802

sales@pdfsupply.com



GE Fanuc Automation

Programmable Control Products

*Series 90™ -70
Hot Standby CPU Redundancy*

User's Guide

GFK0827

December 1993

Warnings, Cautions, and Notes as Used in this Publication

Warning

Warning notices are used in this publication to emphasize that hazardous voltages, currents, temperatures, or other conditions that could cause personal injury exist in this equipment or may be associated with its use.

In situations where inattention could cause either personal injury or damage to equipment, a Warning notice is used.

Caution

Caution notices are used where equipment might be damaged if care is not taken.

Note

Notes merely call attention to information that is especially significant to understanding and operating the equipment.

This document is based on information available at the time of its publication. While efforts have been made to be accurate, the information contained herein does not purport to cover all details or variations in hardware or software, nor to provide for every possible contingency in connection with installation, operation, or maintenance. Features may be described herein which are not present in all hardware and software systems. GE Fanuc Automation assumes no obligation of notice to holders of this document with respect to changes subsequently made.

GE Fanuc Automation makes no representation or warranty, expressed, implied, or statutory with respect to, and assumes no responsibility for the accuracy, completeness, sufficiency, or usefulness of the information contained herein. No warranties of merchantability or fitness for purpose shall apply.

The following are trademarks of GE Fanuc Automation North America, Inc.

Alam Master	CIMSTAR	Helpmate	PROMACRO	Series Six
CIMPLICITY	GEnet	Logicmaster	Series One	Series 90
CIMPLICITY 90-ADS	Genius	Modelmaster	Series Three	VuMaster
CIMPLICITY PowerTRAC	Genius PowerTRAC	ProLoop	Series Five	Workmaster

This manual is a reference to the hardware components, configuration and operation of the Hot Standby CPU Redundancy system for the Series 90™-70 Programmable Logic Controller. This redundancy system is one of several redundancy alternatives that may be incorporated into a Series 90-70 Programmable Logic Controller system (see Appendix A).

The information in this manual is intended to supplement the information contained in the system installation, programming, and configuration information found in the manuals listed below under "Related Publications".

Content of this Manual

Chapter 1. Introduction: describes the basic system features of the Hot Standby CPU Redundancy system Control Strategy, and provides an overview of system components, configuration, and operation.

Chapter 2. Components: describes the hardware components for the Hot Standby CPU Redundancy system.

Chapter 3. Configuration: describes the special configuration requirements of a Hot Standby CPU Redundancy system and provides an example of system configuration.

Chapter 4. Operation: describes the operation of a Hot Standby CPU Redundancy system, fault detection and actions taken, and the on-line repair of a failed component.

Appendix A. Redundancy Alternatives: describes the redundancy alternatives for the Series 90-70 Programmable Logic Controller for those readers not familiar with those alternatives.

Related Publications

For more information, refer to these publications:

Genius I/O System User's Manual (GEK-90486-1). Reference manual for system designers, programmers, and others involved in integrating Genius I/O products in a PLC or host computer environment. This book provides a system overview, and describes the types of systems that can be created using Genius products. Datagrams, Global Data, and data formats are defined.

Genius Discrete and Analog Blocks User's Manual (GEK-90486-2). Reference manual for system designers, operators, maintenance personnel, and others using Genius discrete and analog I/O blocks. This book contains a detailed description, specifications, installation instructions, and configuration instructions for discrete and analog blocks.

Series 90-70 PLC Installation Manual (GFK-0262). This book describes the hardware components in a Series 90-70 PLC system, and provides the details of system installation.

Logicmaster 90-70 Programming Software User's Manual (GFK-0263). A programming software user's manual for system operators and others using the Logicmaster 90-70 software to program, configure, monitor, or control a Series 90-70 PLC system.

Series 90-70 PLC Reference Manual (GFK-0265). Reference manual which describes operation, fault handling, and Logicmaster 90-70 programming instructions for the Series 90-70 PLC.

Series 90-70 Remote I/O Scanner User's Manual (GFK-0579). Reference manual for the Remote I/O Scanner, which interfaces a drop containing Series 90-70 modules to a Genius bus. Any CPU capable of controlling the bus can be used as the host. This book describes the Remote I/O Scanner features, configuration, and operation.

Series 90-70 Bus Controller User's Manual (GFK-0398). Reference manual for the bus controller, which interfaces a Genius bus to a Series 90-70 PLC. This manual describes the installation and operation of the Bus Controller. It also contains the programming information needed to interface Genius I/O devices to a Series 90-70 PLC.

We Welcome Your Comments and Suggestions

At GE Fanuc automation, we strive to produce quality technical documentation. After you have used this manual, please take a few moments to complete and return the Reader's Comment Card located on the next page.

Henry A. Konat
Senior Technical Writer

Contents

Chapter 1	Introduction	1
	Hot Standby CPU Redundancy Product	1
	Features of the Hot Standby CPU Redundancy Product	3
	Benefits of the Hot Standby CPU Redundancy Product	3
	I/O Systems for Hot Standby CPU Redundancy Systems	4
	GeniusI/O System	4
	LocalI/O System	4
	Cable Connections	4
	Control Strategy	5
	Basic Hot Standby Operation	5
	Redundancy CPU Module	7
	Redundancy Communications Module	7
	Bumpless Switching	8
	Synchronized CPUs	8
	Effect on Scan Time	8
	Fail Wait Time	8
	Switch to Backup Unit Time	8
	Configurable Backup Data Size	9
	On-Line Programming	9
	On-Line Repair	9
	Programming Considerations	10
	Configuration Requirements	10
	Definition of Terms	11
	Commonly Used Acronyms	12

Contents

Chapter 2	System Components	13
	Redundancy CPU	13
	CPU Architecture	14
	CPU Features	15
	CPU Mode Switch	16
	Memory Protect Keyswitch	17
	CPU Status LEDs	17
	Battery Connectors	17
	Serial Port Connector	18
	Expansion Memory Board	18
	Redundancy Communications Module	19
	RCM Features	19
	RCM System Status LEDS	20
	Unit Selection Pushbutton	21
	RCM Connectors	21
	Bus Transmitter Module	22
	LED Status Indicators	22
	BTM Connectors	23
	Bus Receiver Module	23
	I/O Bus Signal Termination	24
	LED Status Indicators	24
	BRM Connectors	24
	Genius Bus Controller	24
	Genius Bus Controller User Features	25
	LED Status Indicators	25
	GBC Connectors	26
	Racks	26

Contents

Chapter 3	Configuration	27
	Configuring a Hot Standby CPU Redundancy System	27
	Redundancy System Requirements	28
	Basic Redundancy System Setup	28
	Logicmaster 90 Configuration	28
	I/O System Configuration	28
	Screens for Fault Category Configuration	29
	Handling Folders	30
	Configuration with Logicmaster 90-70	30
	Configuration of a Redundancy CPU Module	31
	Redundant CPU Requirements	33
	Redund Type	34
	Background Window	34
	Normal Sweep Mode	34
	Constant Window Sweep Mode	35
	Constant Sweep Mode	35
	Ctrl Strgy	36
	Fail Wait	36
	Shared I/O	36
	Configuring a CPU Expansion Memory Board	39
	Configuration of a Redundancy Communications Module	40
	Configuration of a Genius Bus Controller	42
	Paired GBC Parameter	42
	Configuring a Primary Redundant PLC	44
	Select the Redundancy CPU Module	45
	Select an Expansion Memory Board	46
	Configure the Redundant Communications Module	47
	Configure a Genius Bus Controller	48
	Configure Genius I/O Blocks	50
	Configure the Bus Transmitter Module	51
	Configuring a Secondary Redundant PLC	52
	Change Redund Type	53

Contents

Chapter 4	Operation	55
	Section 1: System Operation	55
	Power-Up Sequence of a Redundant CPU	55
	Incompatible Configurations	56
	Resynchronization of the Redundant CPU	57
	Hot-Standby Redundancy Control Strategy	58
	Synchronous Scan	59
	First Data Transfer %I, %AI and Synchronization	59
	Data Transfer from Backup Unit to Active Unit	60
	Second Data Transfer %Q, %AQ, %R, and %M	61
	Switching Control to Backup Unit	61
	Role Switch SVCREQ	62
	%S References for CPU Redundancy	63
	Redundancy CPU Considerations	64
	Features not Available with CPU 780	64
	I/OInterrupts	64
	Timed Interrupts	64
	VME Integrator Racks	64
	STOP/IOSCAN Mode	64
	Flash Operation	64
	Differences in Operation for CPU 780	65
	RUN Disabled Mode	65
	Configuration of Fault Actions	67
	STOP to RUN Mode Transition	68
	Background Window Time	68
	Background User Checksum and Background Window Timing Instructions	69
	Miscellaneous Operation Information	70
	Timer and PID Function Blocks	70
	Timed Contacts	70
	OVR_PRE %S Reference	70
	Genius Bus Controller Switching	71

Contents

Section 2: Fault Detection and Control Actions	72
Fault Detection	72
Fault Categories	72
Changing Fault Category Actions	73
PLC Fault Table	74
Faulting RCMs, Losing Links, and Terminating Communications	75
Fault Actions in a CPU Redundancy System	77
On-Line Repair	80
Maintaining Parallel Bus Termination	80
On-Line Repair Recommendations	80
Power Supply	81
Racks	81
Central Processor Unit	81
Redundancy Communications Module and Cables	81
Redundancy Communications Link Failures	82
Bus Transmitter Module	82
Genius Bus Controller	82
Genius Bus	83
Genius Blocks	83
Appendix A Redundancy Alternatives	85
Redundancy Alternatives	85
Series 90-70 Redundancy Through Application Logic	88

Contents

Figure 1. Example of a Local I/O Configuration with Expansion Racks in a Hot Standby CPU Redundancy System	5
Figure 2. Synchronized Hot Standby CPU Redundancy System Configuration	6
Figure 3. CPU 780 Locations in a Hot Standby CPU Redundancy System	14
Figure 4. Redundancy CPU - IC697CPU 780	15
Figure 5. Redundancy Communications Module - IC697RCM711	19
Figure 6. Example of RCM Location in a Hot Standby CPU Redundancy System	20
Figure 7. Example of Multiple Genius Busses in a Hot Standby CPU Redundancy System ...	26
Figure 8. Active and Backup Sweeps	59
Figure 9. Guide to Selection of Redundancy Option Key for Table 1 (Redundancy Options) ..	86

Contents

Table 1. Capacities for Redundancy CPU, IC697CPU780	14
Table 2. Valid Operating Mode Selection	16
Table 3. Expansion Memory Boards for CPU 780	18
Table 4. Shared I/O Data Parameters	37
Table 5. Shared I/O Reference Values	37
Table 6. Transfer Data Size	38
Table 7. Definition for % S Reference for Redundancy Status	63
Table 8. Fault Zoom Help Text for Redundancy Error Codes	74
Table 9. Maskable Fault Group Descriptions	77
Table 10. Maskable Fault Group Actions	78
Table 11. Non-Maskable Fault Group Descriptions	79
Table 12. Non-Maskable Fault Action Descriptions	79
Table 13. Redundancy Options	87

Chapter 1

Introduction

This chapter is an introduction to a method of CPU Redundancy for the Series 90-70 Programmable Logic Controller which is referred to as the Hot Standby CPU Redundancy product.

The contents of this chapter provide:

- a basic description of what Hot Standby CPU Redundancy is;
- tells what it does for you - the user;
- provides a basic description of the components of the Hot Standby CPU Redundancy system;
- provides a basic description of how a system is configured using the Logicmaster 90-70 programming software configurator function;
- lists certain restrictions that you must be aware of;
- and defines terminology unique to this product.

Note

For those who are not familiar with the various redundancy alternatives which may be applied to a Series 90-70 PLC system, please refer to Appendix A before proceeding with this chapter. *For those who are familiar with those redundancy alternatives please proceed with the discussion of the 'Hot Standby CPU Redundancy Product' below.*

Hot Standby CPU Redundancy Product

CPU Redundancy for the Series 90-70 Programmable Logic Controller provides a method of allowing a critical application or process to continue operating if a failure occurs in any single component. The CPU Redundancy system described in this guide is the **Hot Standby CPU Redundancy** product. A Hot Standby CPU Redundancy system consists of two CPUs connected to one or more Genius I/O buses. Each PLC is configured as either Primary or Secondary. The Primary PLC is the preferred PLC and

contains all redundant Genius Bus Controllers at Serial Bus Address 31; the Secondary PLC contains all redundant Genius Bus Controllers at Serial Bus Address 30. The CPU that currently controls the system is called the *active* unit, the other CPU is the *standby* unit.

If certain system failures are detected in the active unit, control is switched to the standby unit. Control can also be switched by depressing a pushbutton on the Redundancy Communications Module, or through the user's logic program. When a switch of control occurs, the units switch roles; the active unit becomes the standby unit and the standby unit becomes the active unit.

Each PLC *must have a Redundancy CPU module* (catalog number IC697CPU780) *and a Redundancy Communications module* (IC697RCM711) which provides the synchronization link between the two units, (and a Bus Transmitter Module (IC697BEM713)). The scanning process of both CPUs is synchronized to keep active and standby units in lockstep to minimize "bumps" or upsets to the process when switching from the active to the standby unit. The effect of this action is a bumpless switch.

The Series 90-70 CPU Redundancy system runs synchronously with a transfer of all control data that defines machine status and any internal data needed to keep the two CPUs operating in sync, and is capable of executing the same program and obtaining the same results. The transfer of data from the active unit to the standby unit occurs once per sweep. These CPU to CPU transfers are checked for data integrity.

Features of the Hot Standby CPU Redundancy Product

- Bumpless switching
 - *Synchronized* CPUs
 - 20 millisecond scan extension (nominal). This figure is variable, depending on amount of data transferred.
 - One scan switching (in most cases)
 - Configurable backup data size
- No single point of failure (excluding Genius I/O)
- Redundant backup communications
- On-line repair of failed component
- On-line programming
- Same or different programs in Primary and Secondary units
- Redundancy CPU has a 16 MHz microprocessor, configurable memory and configurable addressing capacity
- Redundancy Communications Module
 - Manual pushbutton switch for switching control between active and backup CPUs
 - Five Status LEDs
 - Board OK
 - Local System Ready
 - Local System Active
 - Remote System Ready
 - Remote System Active
- Status Bits (%S) reflect redundancy status of Primary/Secondary units
- Program control switching
- Memory parity and checksums
- Common I/O on Genius bus
- Background Diagnostics
 - Processor test
 - PLC CPU EPROM CRC Validation
 - User program checksumming
 - Time-of-Day/ElapsedTime Clock test
- Memory Protect Keyswitch

Benefits of the Hot Standby CPU Redundancy Product

Implementation of the Hot Standby CPU Redundancy product provides you with a method of ensuring that a critical control system or process is uninterrupted in the event of a failure of any single component (excluding I/O) of the PLC system.

I/O Systems for Hot Standby CPU Redundancy Systems

Both Series 90-70 Local I/O and Genius I/O systems can be present in a Hot Standby CPU Redundancy control system. The two units are not required to have matching I/O systems. They may have different numbers of I/O racks, and different local I/O or option modules.

Genius I/O System

A Genius I/O system is the I/O system that is included in the redundancy system as shown below. The system can have multiple Genius I/O buses. Any Genius device can be placed on the bus (Genius blocks, Remote I/O Scanner, etc.). The Genius devices are under control of the active unit in the Redundancy system. The Genius Bus Controller in the Primary Unit has a Serial bus Address of 31; the Genius Bus Controller in the Secondary Unit has a Serial Bus Address of 30. Data from Serial Bus Address 31 is the preferred data when data is being sent from both units to devices on the Genius bus.

Local I/O System

Local I/O can be configured in the overall PLC system; however, **it is not** part of the Hot Standby CPU Redundancy system. Control of Local I/O is done normally through the user's logic program. The user may choose to transfer or not transfer this data. A failure in the Local I/O system will affect the system as described in GFK-0265, the Series 90-70 Programmable Controller Reference Manual.

Cable Connections

The I/O system is configured "normally" except as described below (see the following figure). That is, a Bus Transmitter Module configured in rack 0 is connected through a parallel I/O cable to a Bus Receiver Module in the next rack. The link is continued from this Bus Receiver Module to the Bus Receiver Module in the next rack. This link is continued with a maximum of six expansion racks. Then, the last Bus Receiver is connected via an I/O cable with built-in termination (catalog IC697CBL811 (10 feet (3m)) or IC697CBL826 (25 feet (7.5m))). The last module in the parallel I/O bus link must be a Redundancy Communications Module (RCM). This terminated I/O cable allows replacement of the RCM without interrupting the running system. If no expansion racks are used, the terminated I/O cable is connected directly from the Bus Transmitter Module to the Redundancy Communications Module.

Note

The exception to a normally configured system is that Rack 7, which normally can contain I/O modules is not available for physical I/O modules in a Hot Standby CPU Redundancy system.

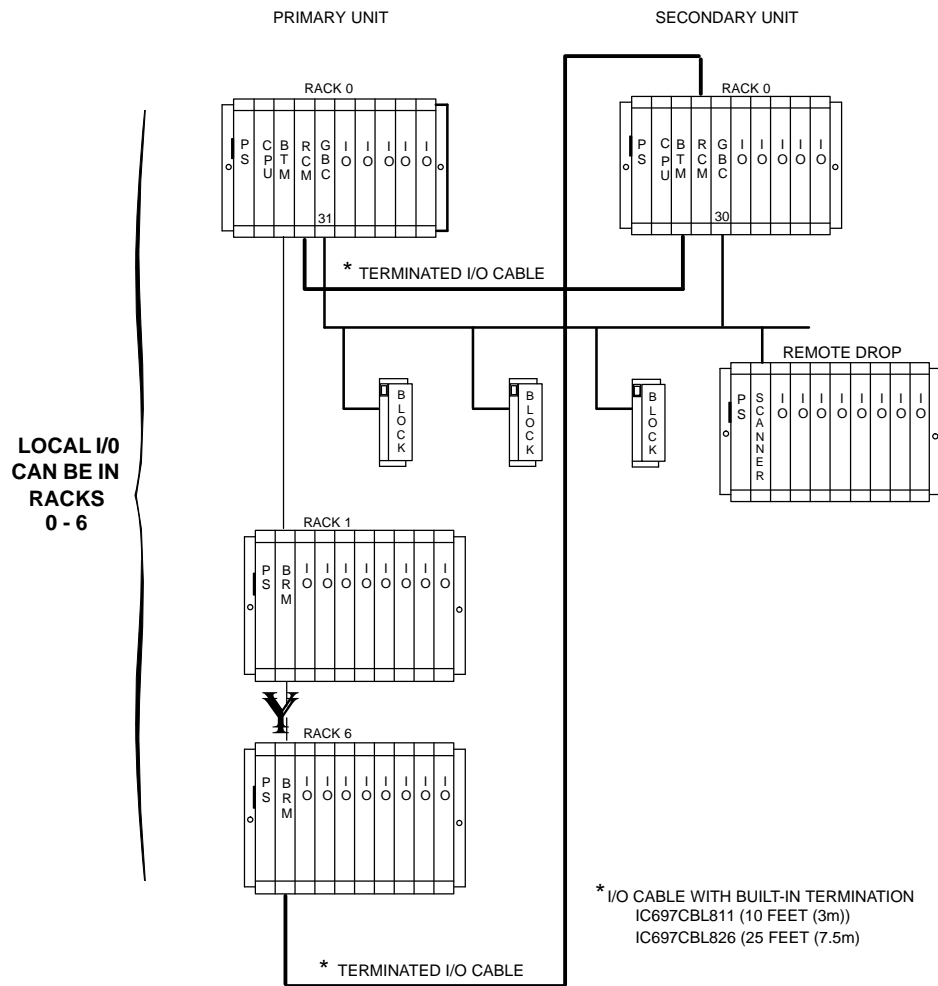

Figure 1. Example of a Local I/O Configuration with Expansion Racks in a Hot Standby CPU Redundancy System

Control Strategy

Control strategy refers to the type of redundancy alternative that may be used. For the Hot Standby CPU Redundancy product, the control strategy is referred to as *Genius Hot Standby* (GHS). The control strategy must be selected when configuring the system with the LogiMaster 90-70 programming Software *Configurator* function.

Basic Hot Standby Operation

In a basic Genius Hot Standby CPU Redundancy system, Genius blocks receive outputs from two PLCs (Primary PLC and Secondary PLC), but they are normally controlled directly by the Genius Bus Controller at serial bus address 31 (Genius Bus Controller in the Primary PLC). If no output data is available from bus address 31 (the preferred data)

for three consecutive Genius I/O bus scans, the outputs are then controlled by the Genius Bus Controller at serial bus address 30 (Genius Bus Controller in the Secondary PLC).

If output data is not available from either bus address 31 or 30, the outputs go to their configured default (OFF or hold last state). The PLC at serial bus address 31 always has priority, therefore when the PLC with serial bus address 31 is On-line, it always has control of the outputs.

The redundancy system configuration is shown in the following figure. This example configuration shows only the redundancy system components. As described previously, a system can also contain Local I/O which is not a part of the redundancy scheme.

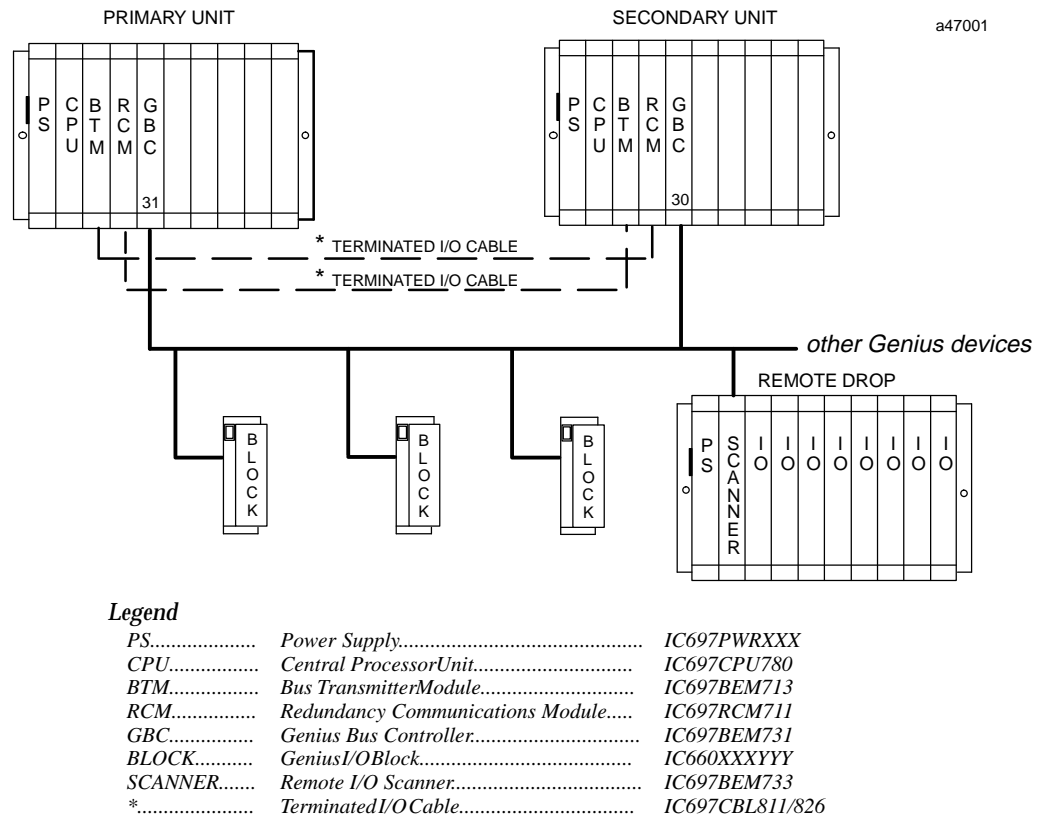

Figure 2. Synchronized Hot Standby CPU Redundancy System Configuration

Redundancy CPU Module

The same model of CPU must be installed in both the Primary and Secondary PLCs. This CPU, which is the only CPU that currently supports synchronized Hot Standby CPU redundancy, is the CPU 780 (catalog number IC697CPU780). This CPU is similar to the existing IC697CPU782 CPU in that it has an 80386DX microprocessor which operates at a speed of 16 MHz, supports floating point calculations, and requires an expansion memory board which can be 128 KBytes, 256 Kbytes with 256 KBytes of non-volatile flash memory, 256 KBytes or 512 KBytes.

NOTE

It is important to note that the following features available with other Series 90-70 CPUs **are not supported** by the CPU 780: I/O interrupts, timed interrupts, the VME Integrator Racks (IC697CHS782 and IC697CHS783), Flash memory operation, and STOP/IOSCAN mode. In addition, the operation of several other features is changed. For more detailed information on these features, please see Chapter 4.

As with the other Series 90-70 CPUs, the CPU 780 must be installed in slot 1 of rack 0 (CPU rack). The Primary unit and the Secondary unit must each have a Redundancy CPU installed in slot 1 of rack 0 with one CPU configured as the Primary CPU and the other CPU configured as the Secondary CPU. Configuration of the CPU 780 in the Primary unit and the CPU 780 in the Secondary unit must be done separately (see Chapter 3 for details of configuration with the Logicmaster 90-70 configurator function).

Redundancy Communications Module

The Redundancy Communications Module (RCM), catalog number IC697RCM711, provides a path (see Figure 1) for sharing data between the two CPUs in the redundant system. The RCM has five LEDs:

- BOARD OK
- LOCALSYSTEMREADY
- LOCALSYSTEMACTIVE
- REMOTESYSTEMREADY
- REMOTESYSTEMACTIVE.

These LEDs report the status of the health of the RCM and the control status of the Hot Standby CPU Redundancy system. The status provided by these LEDs is also provided in an area of %S memory (%S33 through %S39) which is accessible from the user logic program but cannot be altered or overridden.

The module has a momentary pushbutton switch which when depressed for 1 second and released allows you to manually switch control from the *active* unit to the *standby* unit. The switch between units can also be controlled through user logic implementation of a SVC_REQ function that is activated by a discrete input point. Both of these switch requests may only be made every 10 seconds.

In a synchronized system, I/O data is controlled by only one unit (the active unit) but is shared between both units (active and backup units). The RCM provides the path for a synchronizing message from the active to the backup unit which is used to synchronize

the two CPUs and provides the communications path for the transfer of I/O data between the two units. An RCM must be configured in both the Primary PLC and the Secondary PLC. The RCM must reside in the CPU rack (rack 0) in a system and there can be no empty slot between the RCM and the CPU (there can be other modules).

Bumpless Switching

Bumpless switching occurs when the active unit fails and system control is transferred to the backup unit without affecting the operation of the process under control.

Synchronized CPUs

For bumpless switching to occur, the CPU in the active and backup units must operate in a synchronous fashion, that is, the operation of both units must occur at the same time (or as close to the same time as possible). There are two synchronization points in the sweep: one immediately after the input scan and the other immediately before the output scan.

Synchronization data is passed from the active to the backup unit at the first synchronization point, which occurs after the input scan. Specifically, after the inputs are scanned, the inputs that were just read (%I and %AI) are sent from the active to the backup unit and the synchronization message is passed after the input data.

The second synchronization point occurs immediately after the end of the logic solution before the output scan begins. During this time, all remaining control data, including the %Q, %AQ, %M and %R memories is transferred from the active unit to the backup unit.

Effect on Scan Time

When a system is operating normally (no faults exist in the system) redundancy adds about 21 ms (includes 5 ms default background window setting) per PLC scan. The effect on scan time depends on the system configuration. The following number of data points and registers is considered the base configuration on which the 21 ms was calculated.

512 %I, 512 %Q, 512 %M
256 %AI, 256 %AQ
2048 %R

Each additional 1K %I, %Q, or %M data points adds about 1.8 ms to the scan impact (add 25% for each %I or %Q reference if point faults enabled) and each additional 1K of %R, %AI, or %AQ registers adds about 5 ms to the scan impact (add 50% for each %AI or %AQ reference if point faults enabled).

Fail Wait Time

When the active CPU has a failure, the backup CPU will wait for a specified time (in milliseconds) before assuming that the link has failed. This time is referred to as the *Fail Wait* time. The duration of this time must be specified during configuration of both the Primary and Secondary units and can range from 60 ms to 400 ms (in increments of 10 ms), with the default value being 60 ms.

Switch to Backup Unit Time

The amount of time it takes to switch control from the active unit to the backup unit depends on what caused the switch to take place.

If the switch occurs due to a controlled condition such as toggling the unit selection switch on the Redundancy Communications Module or forcing a switch in the user logic program with a SVC_REQ, or because of a fault detected by the PLC CPU, then the switch-over will occur at the beginning of the next sweep. The delay will be up to 1 sweep with the possibility of an input and an output scan after failure detection.

If the switch occurs due to a failure of the PLC CPU (including loss of power), then the switch will occur after the backup unit determines that the active unit has failed to rendezvous at the synchronization point. Failure to rendezvous may take up to 2 failwait timeouts (1 for each link) to determine that a failure has occurred. Control will not transfer, in this case, until both links have been tried unsuccessfully.

Configurable Backup Data Size

The maximum size of the backup data (Shared I/O) is 20 KBytes of Input data and 28 KBytes of Output data. The shared I/O data configuration must be the same in both the Primary and Secondary units. This shared I/O data is transferred from the active CPU to the backup CPU during the CPU sweep process. A total of up to 56 KBytes of user memory is consumed by this data transfer. A maximum of 48 KBytes of the 56 KBytes is the total Shared I/O (20 KBytes %I, %AI; 28 KBytes %Q, %M, %AQ, and %R), while the remainder (8 KBytes) is used by the system for internal data transfers, including synchronizing data.

On-Line Programming

On-line changes to the user logic program are permitted in both the active unit and the backup unit. The programming device must be connected to the system in which changes are to be made in order to make any on-line changes. Note that all precautions regarding power source and grounding for connecting the programming device must be followed in accordance with instructions in the *Series 90-70 Programmable Controller Installation Manual*, GFK-0262.

A connection and disconnection of the parallel programmer cable should only be made with the programmer properly grounded, and Logicmaster 90 software properly booted up and in OFF-LINE mode. For more information, refer to the *Series 90-70 Installation manual*, GFK-0262.

On-Line Repair

A Hot Standby CPU Redundancy system allows you to do on-line repair of failed components without disrupting the process under control. Control status of both the Primary and the Secondary units can be monitored by the LEDS on the Redundancy Communications Modules in each system. When a component of the active unit fails, control is switched to the backup unit. The failed component can then be replaced by removing power from the rack in which it is installed.

After replacing the failed component and returning power to the rack, the backup unit will resynchronize with the currently active unit. The unit which had failed and was previously the active unit will determine its role in the system as part of the resynchronization process. If it is the Primary unit (with Serial Bus Address 31) it will once again become the active unit, the unit with Serial Bus Address 30 (Secondary unit) will again become the backup unit. *For more detailed information on replacing failed components and resynchronization, see Chapter 4, "System Operation".*

Programming Considerations

There are several features in the operation of the Redundancy CPU which are not supported or are different than operation of other CPUs. These features are listed below and are described in detail in Chapter 4, "System Operation".

The following features are not available with the Redundancy CPU (CPU 780):

- I/O Interrupts
- Timed Interrupts
- VME Integrator Rack
- STOP/IOSCAN mode
- Flash memory operation

The operation of the following features is different with the CPU 780 than with other Series 90-70 CPUs:

- RUN/DISABLED mode
- Configuration of fault actions
- STOP to RUN mode
- Default Background Window Time

Configuration Requirements

The Redundancy CPU and the Redundancy Communications Module must be configured into the redundancy system. There are several additional parameters (other than the normal CPU parameters) that must be configured with the Logicmaster 90-70 Configurator function which are unique to the Hot Standby CPU Redundancy system. The following items require configuration when specifying the CPU 780 (the Redundancy CPU) as the CPU for configuration:

Configuration Parameter	Description
<i>Fail-wait</i> (60 ms to 400 ms)	The time to wait on a failed active PLC before switching to the backup CPU. The default value is 60 ms.
<i>Control Strategy</i>	The control strategy for the current configuration. Configured as a three-character identifier (GHS for Hot Standby CPU Redundancy). The default value is GHS (currently the only value that is valid).
<i>Shared I/O References</i>	The references within the control of the Redundancy system; up to 20 KBytes of Input data and 28 KBytes of Output data is transferred. The references which may be used as shared I/O are %I, %Q, %AI, %AQ, %R, and %M.
<i>Redund Type</i>	Whether the CPU being configured is the Primary or Secondary CPU in the Redundancy system. Redund Type has three possible values: PRIMARY, SECONDARY, or SIMPLEX. SIMPLEX (not supported in this release of the product) indicates a non-redundant system. The default value is PRIMARY.

The Primary Unit and the Secondary Unit must be configured separately. That is, the programming device should be connected directly to either the Primary or the Secondary Unit to configure that unit. When you have completed configuring that unit, disconnect the programmer from the configured unit and move it to the other unit and proceed with configuration of the second unit. Refer to Chapter 3, "System Configuration" for details of configuring a Redundancy system

Definition of Terms

Several new or unfamiliar terms are used throughout this manual which are relevant to the discussions of CPU Redundancy. These terms are defined in the following table.

Term	Definition
Active Unit	The unit that is actively controlling the process.
Backup Unit	That unit that is synchronized with the active unit and able to take over the process.
CPU Redundancy	A system with two PLC CPU units cooperating to control the same process.
Critical Component	A component whose failure causes the PLC (either active or backup) in which it resides to stop.
Hot Standby	A feature of Genius blocks whereby the block prefers output data from the Bus Controller at Serial Bus Address 31. When inputs from that Bus Controller are not available, the block takes output data from the Bus Controller at Serial Bus Address 30. If inputs from neither Controller are available, the block places its outputs in the designated default state.
Local Unit	The RCM LEDs and %S status bits refer to the PLC in which they reside as the "Local Unit".
Primary Unit	The unit in which the Genius Bus Controller's Serial Bus Address is 31.
Redundancy	A system feature that has multiple elements controlling the same process to provide alternate functional channels in case of failure.
Remote Unit	The RCM LEDs and status bits refer to the other PLC as the "Remote Unit". For example, the Primary Unit is the Remote Unit to the Secondary Unit and likewise the Secondary Unit is the Remote Unit to the Primary Unit.
Secondary Unit	The unit in which the Genius Bus Controller's Serial Bus Address is 30.
Synchronized	A unit is considered to be synchronized when it has received the latest status information from the Active unit and is running the PLC program in parallel.

Commonly Used Acronyms

A list of acronyms used in this manual are defined for your convenience in the following table.

Acronym	Definition
BRM	Bus Receiver Module
BSM	Bus Switching Module
BTM	Bus Transmitter Module
CPU	Central Processor Unit
EPROM	Erasable Programmable Read Only Memory
GBC	Genius Bus Controller
GHS	Genius Hot Standby Redundancy
GMR	Genius Modular Redundancy
HHM	Hand Held Monitor
LED	Light Emitting Diode
OI	Operator Interface
PLC	Programmable Logic Controller
PROM	Programmable Read-Only Memory
RAM	Random Access Memory
RCM	Redundancy Communications Module
PLD	Relay Ladder Diagram
SBA	Serial Bus Address
SNP	Series 90 Protocol
VME	VersaModule Europe: the backplane standard used by the Series 90-70 PLC system

Chapter 2

System Components

This chapter describes the hardware components for a Hot Standby CPU Redundancy system. It describes the modules required for the system and provides catalog numbers of the components. For detailed installation instructions for the Series 90-70 PLC, refer to GFK-0262, the *Series 90-70 Programmable Controller Installation Manual*.

Redundancy CPU

The IC697CPU780 Central Processing Unit (CPU) has been designed specifically for Series 90-70 Hot Standby CPU Redundancy applications. *This is the only Series 90-70 CPU that currently supports CPU redundancy.*

Note

It is important to note that the following features available with other Series 90-70 CPUs **are not supported** by the CPU 780: I/O interrupts, timed interrupts, the VME Integrator Racks (IC697CHS782 and IC697CHS783), Flash Memory operation, and STOP/IOSCAN mode. In addition, the operation of several other features is changed. For more detailed information on these features, please see Chapter 4.

The CPU 780 supports floating point calculations, offers remote programmer keyswitch memory protection, and has four status LEDs. Operation of this module may be controlled by the three-position RUN/STOP switch on the module, or remotely by an attached programmer and Logicmaster 90-70 Programming Software. Program and configuration data can be locked through software passwords or manually by the memory protect keyswitch. When the key is in the "protected" position, program and configuration data can only be changed by a programmer connected for parallel communications (that is, to the Bus Transmitter Module).

As with the other Series 90-70 CPUs, the CPU 780 *must* be installed in slot 1 of rack 0 (CPU rack). In a Hot Standby CPU Redundancy system, the Primary unit and the Secondary unit must each have a Redundancy CPU installed in slot 1 of rack 0. One CPU is configured as the Primary CPU and the other CPU is configured as the Secondary CPU. Configuration of the CPU 780 in the Primary unit and the CPU 780 in the Secondary unit must be done separately (see Chapter 3 for details of configuration with the Logicmaster 90-70 configurator function). The following figure shows the CPU location in a Hot Standby CPU Redundancy system.

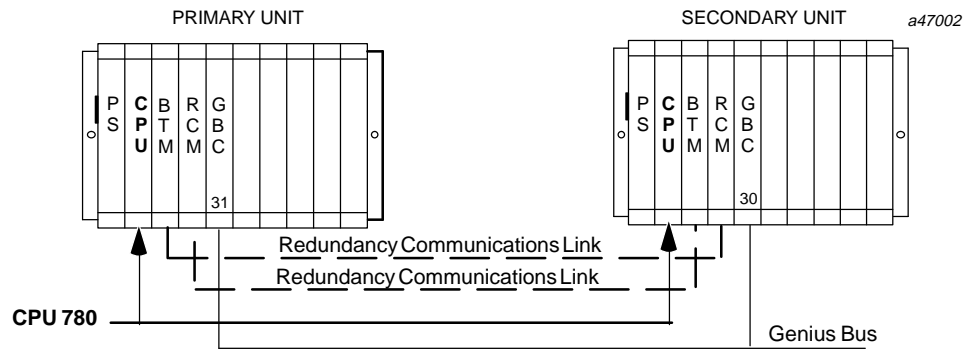

Figure 3. CPU 780 Locations in a Hot Standby CPU Redundancy System

The capacities for the CPU 780 are as listed in the following table.

Table 1. Capacities for Redundancy CPU, IC697CPU780

Speed (MHz)	Processor	Input Points	Output Points	On-Board User Memory	Expansion Memory (KBytes)	Floating Point Math
16	80386DX	12288 †	12288 †	not available	128/256/512	Yes

† The total number of Input points and Output points on the model 780 CPU cannot exceed 12288.

CPU Architecture

The CPU 780 has an 80386DX microprocessor as the main processing element, on-board memory, a dedicated VLSI processor for performing boolean operations and interfaces to a serial port and the system bus. The microprocessor provides all fundamental sweep and operation control, plus execution of non-boolean functions. Boolean functions are handled by a dedicated, VLSI, Boolean Coprocessor (BCP) designed by GE Fanuc.

Program and data memory on the CPU 780 is available by the attachment of an expansion memory board with either 128 Kbytes, 256 Kbytes or 512 Kbytes of battery-backed CMOS RAM, or 256 Kbytes with 256 Kbytes of non-volatile flash memory.

When the CPU board is in storage, disconnect the lithium battery if there is no application program stored in memory. If a program is stored in memory, do not disconnect the battery; otherwise the data will be lost.

Caution

If a *Low Battery Warning* occurs, replace the battery *before removing power from the rack*. Otherwise there is the possibility that data will be corrupted or the program will be cleared from memory.

Watchdog Timer

The CPU provides a watchdog timer to catch certain failure conditions. The value of this timer is controlled by the user from the programmer. The valid range of the watchdog

timer is 10 milliseconds to 1000 milliseconds. The default value for the watchdog timer is 200 milliseconds. The watchdog timer resets at the beginning of each sweep. The fail wait time is included in the watchdog check. The watchdog timer should be set to allow for the expected scan *plus* two fail wait times.

CPU Features

The CPU must reside in Slot 1 in rack 0, the main (CPU) rack. An illustration of the CPU 780 is shown in the following figure, followed by a description of the CPU features.

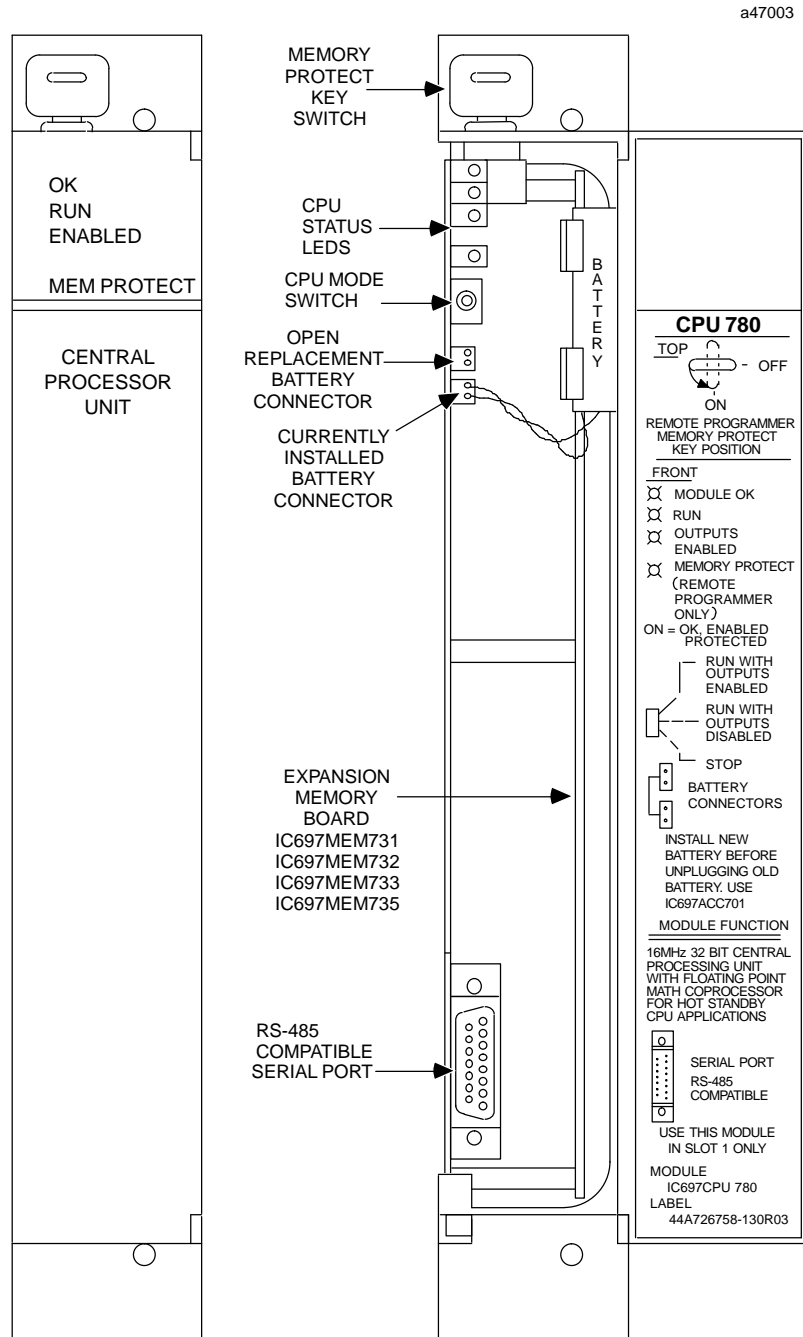

Figure 4. Redundancy CPU - IC697CPU 780

CPU Mode Switch

A three-position toggle switch is mounted near the top of the CPU board. This switch selects one of three operating modes for the CPU: *RUN/ENABLED*, *RUN/DISABLED*, or *STOP*. Although the mode of operation for the CPU can be controlled from both the switch and the programmer, the switch position restricts the ability of the programmer to put the CPU into certain modes.

The following table shows the modes that can be selected by the programmer based upon the position of the CPU mode switch.

Table 2. Valid Operating Mode Selection

CPU Mode Switch Position	Allowable Programmer Mode Command
RUN/OUTPUT ENABLED	STOP RUN/DISABLED RUN/ENABLED
RUN/OUTPUT DISABLED	STOP RUN/DISABLED
STOP	STOP

Run/Outputs Enabled

The top position of the switch is *Run with Outputs Enabled*. With the switch in this position, the CPU executes all portions of the sweep normally.

Run/Outputs Disabled

The middle position of the switch is *Run with Outputs Disabled*. When the switch is in this position, the CPU executes all portions of the sweep normally, but physical outputs are held in their default state, and therefore remain unchanged. Refer to Chapter 4, page 65 for important information on the Run/Disabled mode in a Hot Standby CPU Redundancy system.

STOP

NOTE

The STOP/IOSCAN mode **is not a valid mode** in a redundancy system. Refer to Chapter 4 for detailed information.

The bottom position of the switch is labeled *STOP*. With the switch in this position, the CPU communicates only with the programmer and devices connected to the serial port, and recovers faulted modules. Any of the values in the I/O tables can be changed using the programming computer.

Memory Protect Keyswitch

The Memory Protect keyswitch is located at the top of the module and has two positions: ON and OFF. This keyswitch is used to manually lock program and configuration data. When the key is in the "protected" (ON) position, program and configuration data *can only be changed* by a programmer connected for parallel communications with the CPU 780 (that is, to the Bus Transmitter Module).

CPU Status LEDs

There are four LEDs mounted at the top of the CPU board which indicate the current state of the CPU. The normal state of these LEDs when the CPU is running is *ON*. They are *OFF* or *flashing* to indicate special or failure conditions.

OK

The top LED, labeled *OK* is an indicator of the health of the CPU. It is *ON* when the CPU is functioning properly. The LED blinks when the CPU executes the power-up diagnostics, when the system has failed, and when the remote unit is powered-up. However, when in this state, the CPU can still communicate with the programmer (the CPU cannot communicate with the programmer during power-up diagnostics). The LED is *OFF* when the system has failed and the CPU cannot communicate with the programmer.

RUN

The middle LED, labeled *RUN* is an indicator of the RUN/STOP status of the CPU. It is *ON* when the CPU is in the RUN/ENABLE or RUN/DISABLE mode. When the CPU is in the STOP mode, the LED is *OFF*.

ENABLED

The bottom LED, labeled *ENABLED* indicates the state of the outputs. This LED is *ON* when the outputs are enabled, and *OFF* when the outputs are disabled.

MEM PROTECT

This LED indicates the status of the memory protect keyswitch. When the keyswitch is in the OFF position the LED is OFF, and the CPU can be programmed (if connected for parallel communications, the CPU can be programmed regardless of the keyswitch position). After the program has been verified, the toggle switch for mode selection can be moved to the appropriate mode position. When the memory protect keyswitch is in the ON position, the LED will be ON.

Battery Connectors

Directly below the mode switch are two identical battery connectors. The connector wired to the lithium backup battery cable plugs into one of these connectors to connect the battery to the CMOS memory devices. Two connectors are provided for use when the battery requires replacement. The battery currently installed can remain connected until the new battery is connected, thus minimizing the possibility of losing data.

Serial Port Connector

The 15-pin D-connector at the bottom of the module provides the connection to an RS-422/RS-485 serial port. Its port provides a serial connection to the Work Station Interface (WSI) board installed in the programming computer. For applications requiring RS-232 communications, an RS-232 to RS-422 converter (IC690ACC900) or RS-232 to RS422 miniconverter (IC690ACC901) is available.

Note

An RS-422 Isolated Repeater/RS-232 Converter (IC655CCM590) is available for applications requiring ground isolation where a common ground cannot be established between components.

A standard serial COM port version of Logicmaster 90-70 programming software provides logic programming and configuration for the Series 90-70 PLC using the COM1 or COM2 serial port of the programming device (a Work Station Interface board is not needed). Connections for this configuration are made from the programmer's COM1 or COM2 serial port to the converter to the serial port on the Series 90-70 CPU.

Expansion Memory Board

The CPU 780 requires an expansion memory board (see GFK-0837 and GFK-0531C, or later versions), for more information. The expansion memory board uses battery-backed CMOS RAM memory devices for program and data storage. These expansion memory boards are arranged in a 32-bit memory configuration and can only be used on the models 780, 781 and 782 CPUs. Error checking is provided by a CPU checksum routine. Logic program memory is continually error-checked by the CPU as a background task. Memory parity errors are reported to the CPU when they occur.

These expansion memory boards are not compatible with the expansion memory boards used with the models 771 and 772 CPUs or the Programmable Coprocessor Module. Four versions of the 32-bit memory expansion board are available as listed in the table below. These expansion memory boards are installed on the CPU 780 module by mounting them on a connector provided for that purpose. The CMOS RAM memory on the expansion memory boards is backed-up by the Lithium battery mounted on the CPU module on which the boards are installed.

Table 3. Expansion Memory Boards for CPU 780

Catalog Number	Memory Size
IC697MEM731	128K Bytes
IC697MEM732	256K Bytes w/256 K Bytes Non-Volatile Flash Memory
IC697MEM733	256K Bytes
IC697MEM735	512K Bytes

Note that the current version of the expansion memory boards must be used with the CPU 780. consult your local PLC Distributor or PLC sales office for more information.

Redundancy Communications Module

The Redundancy Communications Module (RCM), catalog number IC697RCM711, provides a communications path for sharing data between the two CPUs in the redundant system. In a synchronized system, I/O data is controlled by one unit (the active unit) but is shared between both units (active and backup units). The RCM provides the communications path between the two units. An RCM must be configured in both the Primary PLC and the Secondary PLC. The RCM must reside in rack 0 and there can be no empty slot between the RCM and the CPU (there can be other modules).

RCM Features

The following figure shows the features of the RCM module.

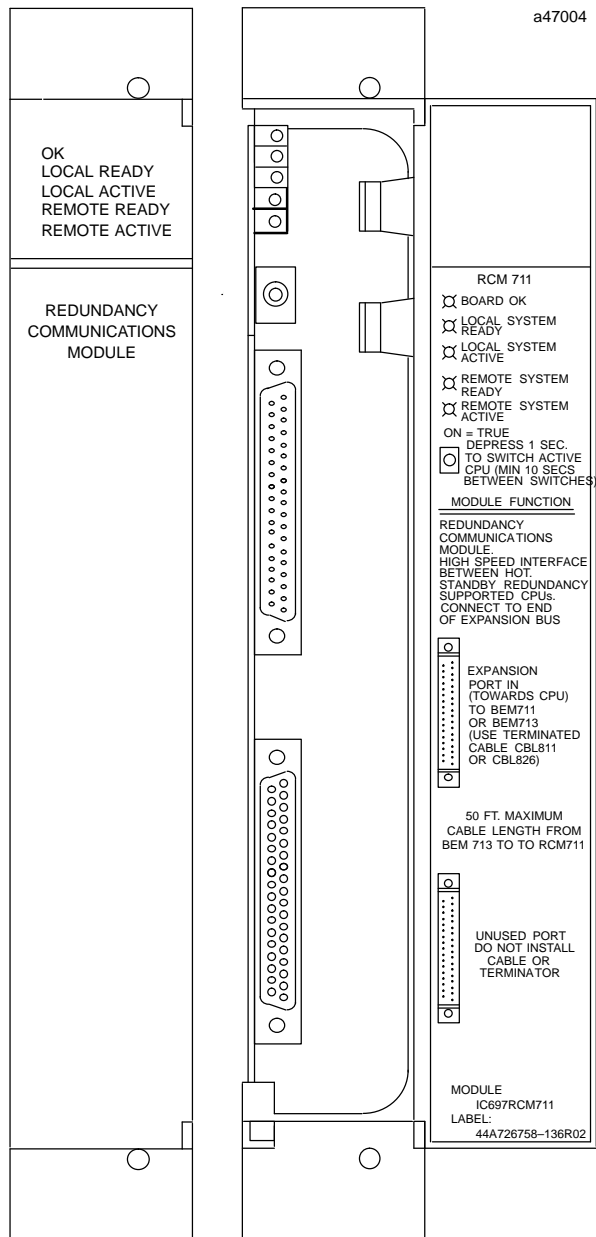

Figure 5. Redundancy Communications Module - IC697RCM711

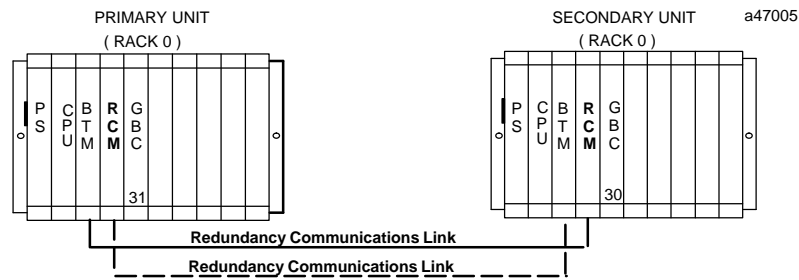

Figure 6. Example of RCM Location in a Hot Standby CPU Redundancy System

RCM System Status LEDs

A Hot Standby CPU Redundancy system has two RCM modules, each with five LEDs and a momentary pushbutton switch for manually switching between the active and the backup units. The LEDs will always be updated by the appropriate system. The RCM has two internal timers that will automatically turn off four of the LEDs (not the board OK LED) if the LEDs have not been updated within a specified time period. The two remote LEDs and the two local LEDs have separate timers since they are controlled from different systems.

The RCM has five LEDs:

- BOARD OK
- LOCALSYSTEMREADY
- LOCALSYSTEMACTIVE
- REMOTE SYSTEM READY
- REMOTE SYSTEM ACTIVE.

These LEDs report the status of the health of the RCM and the control status of the Hot Standby CPU Redundancy system. The status provided by these LEDs is also provided in an area of %S memory (%S33 - %S39) which is accessible from the user logic program but cannot be altered or overridden. The LEDs have the following meanings and uses. Note that the term *Local Unit* when associated with a particular RCM refers to that unit in which the RCM resides. *Remote Unit* refers to that unit in which the RCM is configured by the system for addressing as being in rack 7, slot 1. Each RCM will have an associated local and remote unit.

BOARDOK

This LED will come on when the diagnostics are complete and the RCM has been determined to be operating normally. It will remain on unless the RCM fails.

LOCALSYSTEMREADY

Indicates whether the local unit is ready to become the active unit in a redundant PLC configuration. If the LED is on, the local unit has been configured for redundancy, is in RUN mode, and has performed sufficient initialization, diagnostics, and hand-shaking to take control of the redundant system if selected as the active unit. It is the responsibility of the local unit to set the state of this LED at least once during each sweep; if the local unit is unable to set (or fails to set) the state of the LED, the hardware will force the LED to off after the timer has timed out.

LOCAL SYSTEM ACTIVE

Indicates whether the local unit is the controlling (or active) unit in a redundancy system. It is the responsibility of the local unit to set the state of this LED at least once during each sweep; if the local unit is unable to set (or fails to set) the state of the LED, the hardware will force the LED to off after the timer has timed out.

REMOTE SYSTEM READY

Indicates whether the remote unit is ready to become the active unit in a redundant PLC configuration. If the LED is on, the remote unit has been configured for redundancy, is in RUN mode, and has performed sufficient initialization, diagnostics, and hand-shaking to take control of the redundant system if selected as the active unit. It is the responsibility of the remote unit to set the state of this LED at least once during each sweep; if the remote unit is unable to set (or fails to set) the state of the LED, the hardware will force the LED to off after the timer has timed out.

REMOTE SYSTEM ACTIVE

Indicates whether the remote unit is the controlling (or active) unit in a redundancy scheme. It is the responsibility of the remote unit to set the state of this LED at least once during each sweep; if the remote unit is unable to set (or fails to set) the state of the LED, the hardware will force the LED to off after the timer has timed out.

Unit Selection Pushbutton

The module has a momentary pushbutton switch which when depressed for 1 second and released allows you to manually switch control from the *active* unit to the *backup* unit if the backup unit is *READY*. The status of each pushbutton is checked by the PLC CPU software. The switch between units can also be controlled through user logic implementation of a SVC_REQ function that is activated by user logic. After a switch has been requested, you must wait 10 seconds before requesting another switch.

RCM Connectors

The RCM has two connectors mounted on the front of the board. *The top connector is the only one used.* It is connected via an I/O cable with built-in termination to the last rack of the *other* PLC system. If no expansion rack is used, it is connected to the lower connector on the Bus Transmitter Module of the other system. The I/O cable with built-in termination is available in two lengths:

- IC697CBL811, 10 feet (3 meters)
- IC697CBL826, 25 feet (7.5 meters)

Bus Transmitter Module

A Bus Transmitter Module (BTM), catalog number IC697BEM713, is required in both the Primary PLC CPU rack (rack 0) and the Secondary PLC CPU rack (rack 0) in a Hot Standby CPU Redundancy system. The BTM provides a path for Redundancy communications when connected to the Redundancy Communications Module (RCM). Each PLC system (Primary and Secondary) has a BTM and an RCM in rack 0. The BTM in one unit connects to the RCM in the other unit (or through a series of BRMs if expansion racks are in a system).

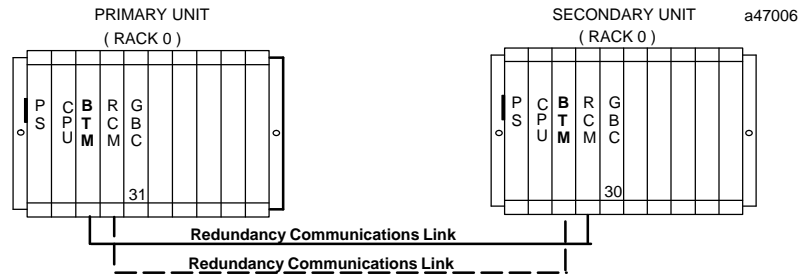

When included as a bus communications module in an I/O expansion system, the BTM is a high speed parallel interface which propagates the I/O bus signals through a cable to a Bus Receiver Module located in the first I/O expansion rack. The BTM also provides a high speed parallel connection to the programmer through the Work Station Interface board installed in the programmer.

LED Status Indicators

There are three LEDs located at the top of the BTM. The LEDs are labeled: OK, PGMR ACTIVE and BUS ACTIVE. As with all other Series 90-70 PLC LEDs, they are visible through the clear plastic lens at the top of the module's cover. The function of each LED is described below.

Module OK

The top LED is the MODULE OK LED and is *ON* when the CPU software completes its power-up configuration of the BTM, and has polled (or attempted to poll) each expansion rack in the system. It is *OFF* when any of these conditions are not met.

Programmer Port Enabled

The middle LED is the Programming Port Active LED. This LED is either *blinking* or *ON* when the programmer and the PLC are communicating. It is *OFF* when they are not communicating.

Expansion Port Enabled

The bottom LED provides the status of the expansion bus.

This LED is either *blinking* or *ON* when the BTM is communicating with the Bus Receiver Modules connected to it through the parallel I/O bus link. It is *OFF* when they are not communicating.

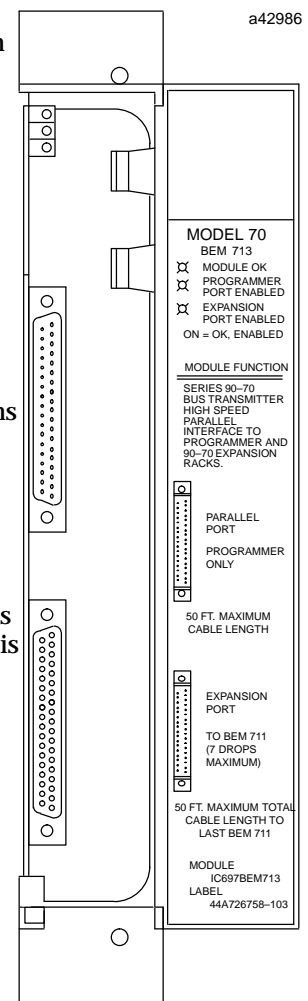

BUS TRANSMITTERMODULE

BTM Connectors

There are two connectors on the front of the BTM board. The top one provides a parallel connection to a Work Station Interface (WSI) board installed in the programmer for the Series 90-70 PLC. Serial connection to Workmaster II is through a programmer cable (IC647CBL703) 10 feet (3 meters) in length (parallel connection to Workmaster is through a parallel I/O cable, IC600WD005A). Standard parallel I/O cables are used to connect the BTM's lower connector to a Redundancy Communications Module in the other Redundancy unit, or to a Bus Receiver Module in the first expansion rack. These connectors are 37-pin connectors. The top one is a male connector, while the lower one is female.

Note

The programmer running Logicmaster 90 Software must be connected to the same power ground as the PLC, unless special isolated drivers are used. The parallel programmer cable should only be connected/disconnected when the programmer is powered-up and offline. Do not power the parallel programmer up or down while connected to a PLC that is running.

Bus Receiver Module

The Bus Receiver Module is required if expansion racks are used in the overall redundancy system.

The Bus Receiver Module (BRM), catalog number IC697BEM711, which must be installed in slot 1 of each expansion rack in a system, is the expansion rack interface to the I/O bus. It provides the link to the I/O bus for I/O modules installed in its rack. The BRM in the first expansion rack connects to the BTM in the CPU rack through a parallel I/O bus cable.

This cable is connected to the bottom connector on the BTM, and to the top connector on the BRM. The next rack to be included in the I/O bus is connected to the lower connector on the BRM in the first expansion rack and the top connector of the BRM in the next rack.

Connection of expansion racks on the I/O bus is continued in this manner until the maximum of 6 expansion racks is connected. The bottom connector in the last expansion rack is connected to the top connector of the RCM in the remote unit. Note that the last bus connection is to an RCM module (instead of a BRM).

Note

The total cable length of all connecting cables between racks on the I/O bus cannot exceed 50 feet (15 meters).

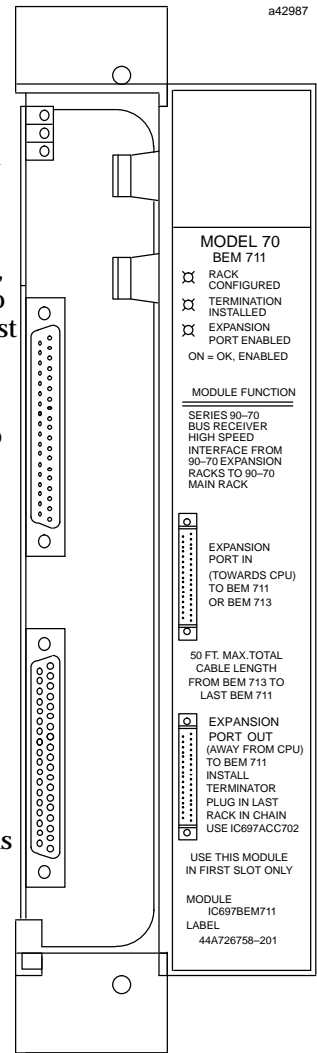

BUS RECEIVER MODULE

I/O Bus Signal Termination

The I/O bus signals must be terminated at the end of the bus. In a standard PLC system this is done by installing a resistor pack, located inside of a terminator plug (catalog number IC697ACC702) on the bottom connector of the BRM module that is installed in the last I/O expansion rack in the system. In a Hot Standby CPU Redundancy system a special I/O cable with built-in termination is used. Do not use the resistor plug with the terminated cable.

LED Status Indicators

There are three LEDs located at the top of the BRM. The LEDs are labeled: OK, LAST RACK, and BUS ACTIVE. The LEDs are visible through the clear plastic lens at the top of the module's cover. The function of each LED is described below.

Board OK

The top LED, the Board OK LED, is *ON* when the CPU software completes its power-up configuration of the expansion rack and at least one module in that rack responds to the CPU requests for information. It is *OFF* when any of these conditions are not met.

Last Rack

The middle LED is the Last Rack LED. This LED is *ON* when the I/O bus terminator plug is installed in the bottom connector of this BRM, and is *Off* when it is not installed. The terminator plug is to be installed only on the BRM that is at the end of the expansion rack I/O bus. All BRMs are shipped from the factory with a terminator plug installed. These terminator plugs must be removed from any expansion rack located between the CPU rack and the last expansion rack.

Expansion Bus Active

The bottom LED provides the status of the expansion bus. This LED is *ON* when the BRM has detected that there has been activity on the expansion bus in the last 500 ms, otherwise it is off. When this LED is *OFF*, the BRM is holding the Series 90-70 I/O modules in its rack in their default state.

BRM Connectors

The BRM has two connectors mounted on the front of the board. The top connector is for the I/O cable connection to either the lower connector on a BTM in the CPU rack, or to the lower connector on another BRM. The lower connector is for an I/O cable connection to the upper connector of a BRM in the next expansion rack on the I/O bus or to the top connector on an RCM. The I/O cable is an 18 twisted-pair cable with a ground shield. The total maximum cable length from the CPU rack to the most distant expansion rack (at the same ground potential) is 50 feet. Standard parallel I/O bus cables that meet this specification are available in lengths of 5, 10, 25, and 50 feet.

Genius Bus Controller

The Genius Bus Controller (GBC), catalog number IC697BEM731, for the Series 90-70 PLC is the interface for the Series 90-70 PLC to a Genius I/O communications system. Configuration of the GBC is simple through use of Logicmaster 90 Configurator software. Genius I/O blocks are scanned asynchronously by the GBC and I/O data is transferred to the CPU once per scan over the backplane of the Series 90-70 PLC rack.

The Hot Standby CPU Redundancy system uses a single Genius bus and requires one GBC module in the Primary PLC and one in the Secondary PLC; however there can be multiple Genius busses configured in this manner in a system. The GBCs in the Primary PLC are assigned SBA 31, and the GBCs in the Secondary PLC are assigned SBA 30. Data from SBA 31 in the Primary PLC is the "preferred" data. The Primary PLC is normally the active unit in the redundancy system.

In a redundancy system the GBCs must be configured for "RED CTRL" redundancy. All of the Genius devices on the Genius bus must also be configured for "Redundancy"

The bus can have up to 30 Genius devices connected to it, with one of the SBAs reserved for the Hand-Held Monitor. Any type of Genius I/O block may be connected to this bus. A Genius I/O device will use the output data received from SBA 31 in preference to data from SBA 30. If the active and backup units switch roles, the GBC will then use the output data from SBA 30.

As a safety feature, a watchdog timer protects each Genius I/O link. This timer is periodically reset by the GBC software. Should it ever expire, the microcontroller on the board ceases functioning and the Channel OK LED turns off. If this happens in a CPU Redundancy system, the other GBC will then drive the Genius I/O blocks. The cause of the link failure must be determined to re-establish communications.

Genius Bus Controller User Features

A Genius Bus Controller can be installed in any slot in rack 0, except for slot 1 which is reserved for the CPU module. It can be installed in any slot in an expansion rack, except slot 1 which must contain a Bus Receiver Module.

LED Status Indicators

The GBC has three LEDs located at the top of the board: one as an indicator of the state of the board, and one to indicate the state of the Genius I/O link. When the board is functionally properly, the top two LEDs are *ON* (third LED currently not used). They are either *blinking* or *OFF* to indicate special or failure conditions. If, after the power-up diagnostics routine has been completed, all LEDs are *OFF*; this is an indication that a board failure has been detected and the board must be replaced.

Module OK

The top LED, labeled OK, indicates the health of the GBC. It is *ON* when the board has successfully completed the power-up diagnostics. If the power-up diagnostics detects a failure or if the board fails during operation, the LED will be *OFF*. The LED *blinks* during the power-up diagnostics and when the GBC is installed in a slot different from the slot specified by the configuration information downloaded from the programmer.

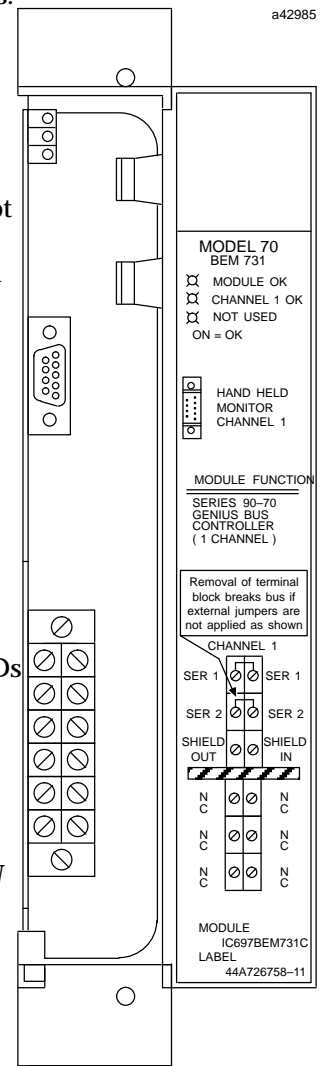

GENIUS BUS CONTROLLER

CH 1 OK

The CH 1 OK LED is the middle LED. It operates identical to the Module OK LED in that it is *ON* after the board has successfully completed the power-up diagnostics and *OFF* if a failure has been detected during the power-up diagnostics, or if its bus or bus controller fails while the CPU is running (even in the STOP mode). If the failure is a bus controller failure, the LED will remain permanently off. If it is a bus failure, such as a broken wire or excessive bus errors, the LED remains off until the failure condition is corrected.

GBCConnectors

A GBC has two connectors. Directly below the LED is a dedicated nine-pin connector for connection to the Hand-Held Monitor. The actual bus connections are made through a 12 point removable terminal board. Six of these terminals are used for connection to the Genius I/O channel. The GBC may be located on either end or in the middle of the bus.

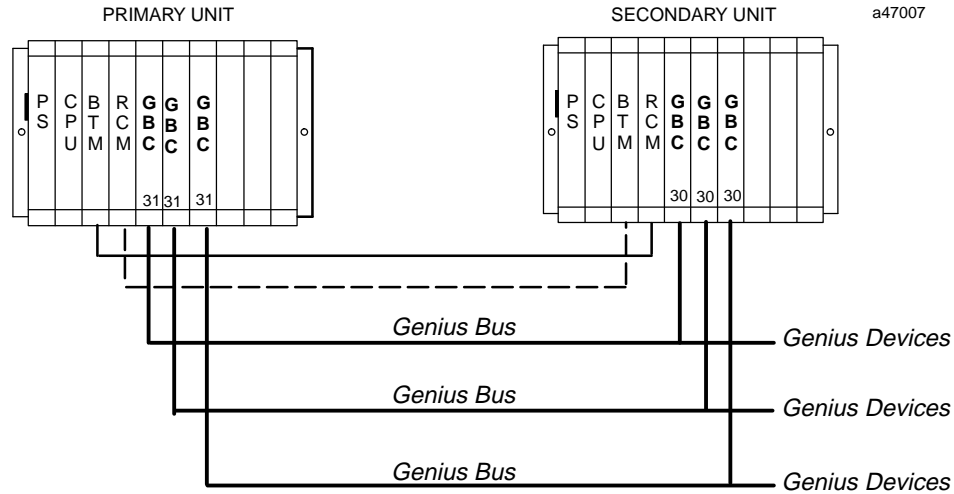

Figure 7. Example of Multiple Genius Busses in a Hot Standby CPU Redundancy System

Racks

The standard series 90-70 I/O racks may be used to contain the modules in a Hot Standby CPU Redundancy System.. These racks include the following:

- IC697CHS750, 5-slot rear mount;
- IC697CHS790, 9-slot rear mount;
- IC697CHS791, 9-slot front mount.

Note

Please note that the Series 90-70 VME Integrator racks (IC697CHS782 and IC697CHS783) are not supported by this release of the Hot Standby CPU Redundancy product.

For detailed information on the Series 90-70 I/O racks, refer to GFK-0262, the *Series 90-70 Programmable Controller Installation Manual*.

Chapter 3

Configuration

This chapter describes how to configure a Series 90-70 PLC system for Hot Standby CPU Redundancy. Several parameters in addition to the normally configured CPU parameters must be configured for the Redundancy CPU 780. A description of all of the parameters for a redundancy system is provided first, followed by an example of a Primary system configuration and a Secondary system configuration.

Configuring a Hot Standby CPU Redundancy System

As discussed previously, when configuring a system for Hot Standby CPU Redundancy, the following parameters require configuration in addition to the CPU configuration parameters that are done for any other CPU78X CPU.

Configuration Parameter	Description
<i>Fail-wait</i>	The time one PLC will wait on one RCM link for the other PLC to respond before faulting that link. The CPU will try both links before continuing its scan. Once the RCM links are marked as failed, one unit or the other must be power cycled to recover them. Range is 60 ms to 400 ms, with the default value being 60 ms.
<i>Control Strategy</i>	The control strategy for the current configuration. Configured as a three-character identifier (GHS for Hot Standby CPU Redundancy). The default value is GHS (currently the only value that is valid).
<i>Shared I/O References</i>	The references within the control of the Redundancy system; limited to total of 20 KBytes for Inputs and 28 Kbytes for Outputs. The references which may be used as shared I/O are %I, %Q, %AI, %AQ, %R, and %M. .
<i>Redund Type</i>	Whether the CPU being configured is the Primary or Secondary CPU in the Redundancy system. Redund Type has three possible values: PRIMARY, SECONDARY, or SIMPLEX. SIMPLEX indicates a non-redundant system. The default value is PRIMARY. <i>SIMPLEX is not a currently supported Redund Type for the CPU 780.</i>

Redundancy System Requirements

For a redundant CPU configuration using the Hot-Standby Redundancy scheme to be valid, the following requirements must be true in both the Primary Unit and the Secondary Unit in the redundancy system.

- One configuration must be set to Primary; the other to Secondary.
- The control strategy configurable parameter must be set to "GHS".
- An RCM must be configured in rack 0 of each system. There can be no empty slots between the RCM and the CPU. For a given unit, the *Local* RCM is the one configured in that unit; the *Remote* RCM is not configured by the user, but is automatically configured by the system to be in slot 1 of rack 7.
- All Genius Bus Controllers in the system must be configured for RED CTRL Redundancy with the redundant pair set for EXTERNAL, or they must be configured for no redundancy.
- If a Genius Bus Controller is set to redundant in a redundant CPU configuration, all of its bus blocks must also be set redundant; if a Genius Bus Controller is set non-redundant in a redundant CPU configuration, all of its bus blocks must also be set non-redundant.
- If the primary/secondary configurable item is set to PRIMARY, all Genius Bus Controllers configured for RED CTRL redundancy must have Serial Bus Address 31. If the primary/secondary configurable item is set to SECONDARY, all Genius Bus Controllers configured for RED CTRL redundancy must have Serial Bus Address 30.
- The Shared I/O selections must match exactly between Primary and Secondary PLCs.

Basic Redundancy System Setup

- Assemble each PLC system and cable the last rack of each system to the RCM of the other PLC using the terminated I/O cable. If there are no expansion racks in the system, cable each BTM to the RCM in the other PLC.

Logicmaster 90 Configuration

- Set the primary CPU to **PRIMARY**.
- Set the secondary CPU to **SECNDARY**.

For both Primary and Secondary CPUs, do the Following:

- Select Data Transfer (SHARED I/O) parameters (up to 20 Kbytes Input data, up to 28 Kbytes Output data).
- Configure the SBA for all Redundancy Genius Bus Controllers (SBA 31 for the Primary; SBA 30 for the Secondary), and **Redund Mode** to "RED CTRL".
- Select fail-wait time. The default value of 60 ms should suffice for most applications.
- Select watchdog timer. Allow for worst case scan time *plus* data transfer time *plus* two fail-wait times (plus a generous margin). Setting this value too small could cause the standby unit to time out during a failure of the active unit.
- Select the programmer window. Set to about 10% of the normal scan time (if scan time is unknown, use default time (*do not exceed the fail wait time*)).
- Select Fault Actions.

I/O System Configuration

- Configure your I/O system as required for your application.

Screens for Fault Category Configuration

A new Fault Category Configuration screen is displayed for the CPU 780. This new screen has two columns of fault actions for the configurable fault groups/categories. The following sample screens show the Fault Category Configuration screens as they appear in Logicmaster 90-70. To access this screen, select the F2 softkey (CPU Configuration) from the Configuration Software main menu. The CPU Configuration menu will be displayed. From this menu select the F5 softkey (Fault Category).

The screen shown below is the Fault Category screen for a redundant system when in the **OFFLINE** mode

```

|PLCTIM | |SNPID |MEMCFG |FLTCFG | | | | | |
1|      2|      3|      4|      5|      6|      7|      8|      9|     10|
>
      FAULT CATEGORY CONFIGURATION

```

Fault Type	Fault		Category
	CFG	PLC	SYNC PLC
Loss of or Missing Rack	D	*	*
Loss of or Missing IOC	D	*	*
Loss of or Missing I/O Module	D	*	*
Loss of or Missing Option Module	D	*	*
System Bus Error	F	*	*
IOC Fault (I/O Bus Fault)	D	*	*
System Config Mismatch	F	*	*

D= Diagnostic; F= Fatal

<< Stand-alone PLC values are editable and must be stored to the PLC with the >>
 << configuration. Synchronized PLC values are fixed and cannot be changed. >>

OFFLINE

D:\LM90\EXEC PRG: EXEC CONFIG INVALID
 REPLACE

The screen shown below is the Fault Category screen for a redundant system when in **MONITOR** or **ONLINE** mode

```

|PLCTIM | |SNPID |MEMCFG |FLTCFG | | | | | |
1|      2|      3|      4|      5|      6|      7|      8|      9|     10|
>
      FAULT CATEGORY CONFIGURATION

```

Fault Type	Fault		Category
	CFG	PLC	SYNC PLC
Loss of or Missing Rack	D	D	F
Loss of or Missing IOC	D	D	F
Loss of or Missing I/O Module	D	D	D
Loss of or Missing Option Module	D	D	D
System Bus Error	F	F	F
IOC Fault (I/O Bus Fault)	D	D	D
System Config Mismatch	F	F	D

D= Diagnostic; F= Fatal

<< Stand-alone PLC values are editable and must be stored to the PLC with the >>
 << configuration. Synchronized PLC values are fixed and cannot be changed. >>

ONLINE

ID: STOP/NO IO ONLINE L4 ACC: WRITE LOGIC CONFIG NOT EQ
 C:\LM90\REDUN PRG: REDUN CONFIG VALID
 REPLACE

The Fault Type is shown at the left. The first column under Fault Category (CFG) shows which faults are FATAL and which faults are DIAGNOSTIC for this CPU, when it is the only running CPU (i.e., stand-alone with no backup available). This column can be edited for each fault group/category to select FATAL or DIAGNOSTIC so that a safe shutdown or fault tolerant operation can be selected for when a failure occurs with no backup ready. The column next to it (PLC) shows the value (F or D) currently stored to the PLC or the defaults if it is not stored.

The next column shows the Synchronized PLC values. These values are either F (FATAL - which causes a transition to *STOP* mode), or D (DIAGNOSTIC - which maintains the current state of the PLC) for this CPU, when it is synchronized. This column cannot be edited.

Handling Folders

It is very desirable from a maintenance standpoint to keep the applications programs identical between PLCs. The best way to handle this is to maintain different folders for each configuration and use the same logic folder for both PLCs. By using this scheme, you would have three folders for the redundant system.

1. Folder "A" - configuration for the Primary unit.
2. Folder "B" - configuration for the Secondary unit.
3. Folder "C" - logic and reference tables for both systems.

It is recommended that for a new system, you should STORE the configuration first, then the logic.

Functionally, it is not necessary to keep the same ladder in both PLCs but it is difficult to maintain such a system. Any ladder changes made in one system would have to be evaluated and hand-keyed in to the other folder. Other than visual inspection, there would be no way to tell if changes made in one system were appropriately made in the other.

Note

When entering either the Programmer Package or the Configuration Package while ONLINE and EQUAL, the folder containing the logic program will be automatically selected.

Configuration with Logictmaster 90-70

To configure the Hot Standby CPU Redundancy system, connect the programmer to either the Bus Transmitter Module for parallel communications or to the RS-485 serial port on the CPU 780 module for serial communications. For detailed information on installation procedures refer to GFK-0262, the *Series 90-70 Programmable Controller Installation Manual*. For detailed information on running Logictmaster 90-70 Programming Software, refer to GFK-0263, the *Logictmaster 90-70 Programming Software User's Manual*.

Any computer running Logictmaster 90 interfacing with the PLC must be connected to the same power ground as the PLC unless special isolated drivers are used. The parallel

cable connecting the PLC to the programmer should only be plugged and unplugged when the programmer is powered up and offline. *Avoid powering the parallel programmer up or down while connected to a running PLC.*

Configuration of a Redundancy CPU Module

The redundancy CPU module, IC697CPU 780 **must** be configured as a rack module in rack 0, slot 1. The procedure for configuring a CPU 780 in a rack is described below. While in the Logicmaster 90 main menu, select the Logicmaster 90 Configuration Package by pressing the F2 softkey. You will then be prompted to enter a folder name or select an existing folder. When you have done this, press the **Enter** key and the Series 90-70 Configuration software main menu will appear.

While in the Configuration Software main menu, select the **I/O** softkey (F1) for I/O Configuration. The default I/O Configuration Rack screen is displayed.

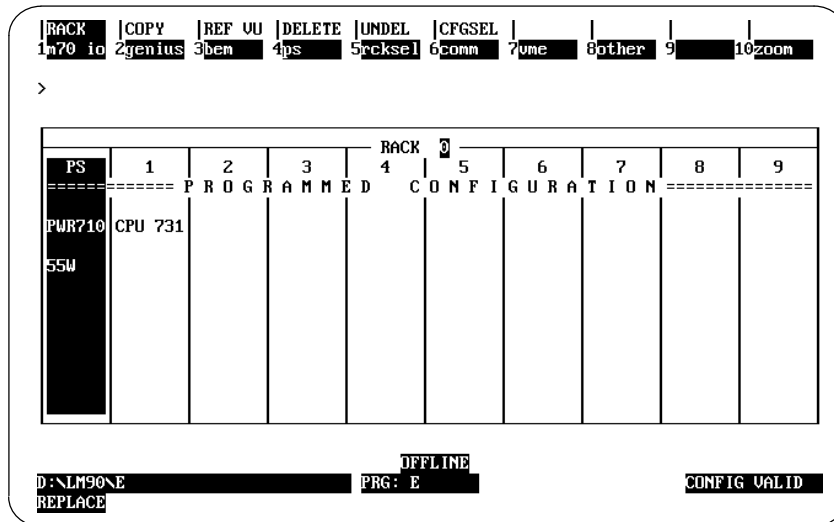

To configure the CPU 780 module position the cursor on rack 0, slot 1, then press the zoom softkey (F10).

The detail screen of the currently configured CPU module is displayed. The following screen shows the CPU module detail screen for the currently displayed module.

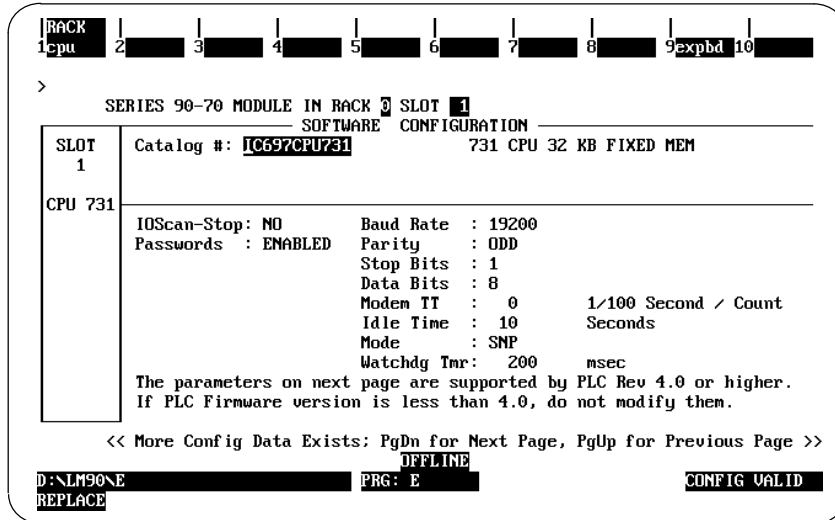

To select the CPU 780 Redundancy CPU module, press the **cpu** softkey (F1). A list of the available CPU modules is displayed with the currently selected CPU module highlighted in reverse video. Move the cursor to the line for the Redundant CPU (catalog number IC697CPU 780), as shown below, and press **Enter**.

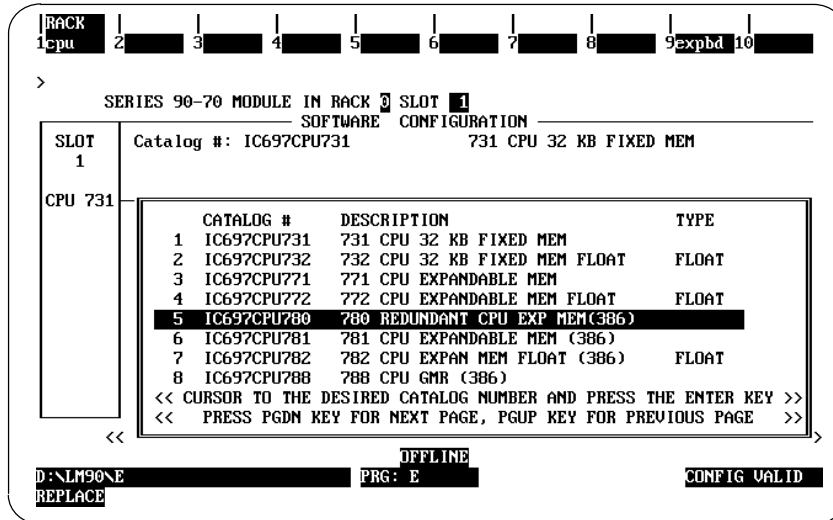

If the existing CPU configuration requires any modification for the redundant CPU configuration, an informative message will be displayed.

Note

The message area can show messages for all possible types of configuration modifications; any number of these messages could be displayed at any one time.

If the existing configuration does not require any modification to suit the redundant CPU configuration, the prompt "REPLACE displayed module ? (Y/N)" will be displayed beneath the softkey strip instead of the message box.

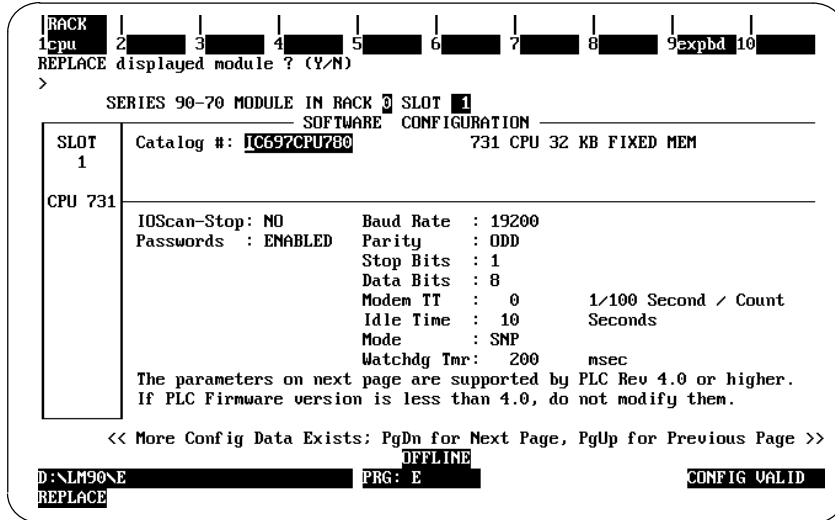

If you answer "Y", page 1 of the detail screen for the redundant CPU (IC697CPU 780) is displayed. If you were to answer "N", the previous CPU is displayed. For the redundant CPU configuration example, the answer is "Y".

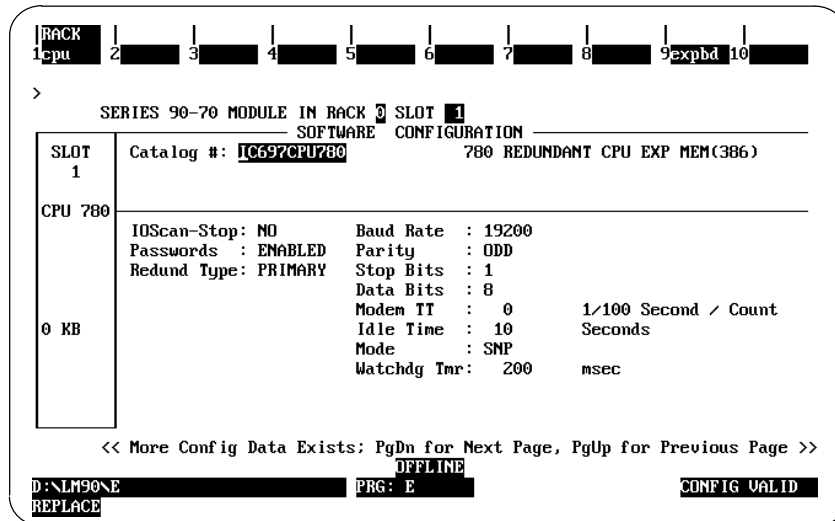

The differences between screen page 1 of the redundant CPU and non-redundant CPU are described below.

Redundant CPU Requirements

The I/O configuration of a redundant CPU has the following restrictions, which are:

1. In a redundant CPU system, rack I/O module interrupts **MUST** be disabled.
2. The SBAs of redundant GBCs in a Primary redundant CPU system must be 31; the SBAs of redundant GBCs in a Secondary redundant CPU system must be 30.

- 3. In a redundant CPU system, RCMs cannot be configured in expansion racks.
- 4. Rack 7 cannot be seen nor edited.

Redund Type

This parameter specifies whether the CPU is configured as the primary controller or the secondary controller. The **Redund Type** has three possible choices: **PRIMARY**, **SECNDARY**, or **SIMPLEX**. The default value is **PRIMARY**.

When this configuration item is set PRIMARY, all configured redundant Genius Bus Controller(GBC) Serial Bus Addresses (SBA) must be 31. If any one of the SBAs is not 31, the message "SBAs of all redundant GBCs in a primary system must be 31: modify (Y/N) ?". Answering "Y" automatically changes all SBAs to 31. Answering "N" leaves this field unchanged.

When this configuration item is set to SECNDARY, all configured redundant Genius Bus Controller(GBC) Serial Bus Addresses (SBA) must be 30. If any one of the SBAs is not 30, the message "SBAs of all redundant GBCs in a secondary system must be 30: modify (Y/N) ?". Answering "Y" automatically changes all SBAs to 30. Answering "N" leaves this field unchanged.

The third choice is SIMPLEX, which is currently not a valid mode for the CPU 780. You can configure the Redund Type for SIMPLEX, but the choice will be rejected when you attempt to STORE the configuration.

Background Window

The default for this parameter for CPU redundancy systems is 5 ms (limited Window mode). The background window runs several diagnostic tests which can be disabled by setting the the background window time to 0. These tests are run in Constant Window and Constant Sweep mode only if the window/sweep time is large enough.

Normal Sweep Mode

The Sweep Mode for the redundant CPU has to be selected. Below is the detail screen (page 2) of a redundant CPU configured for NORMAL sweep mode.

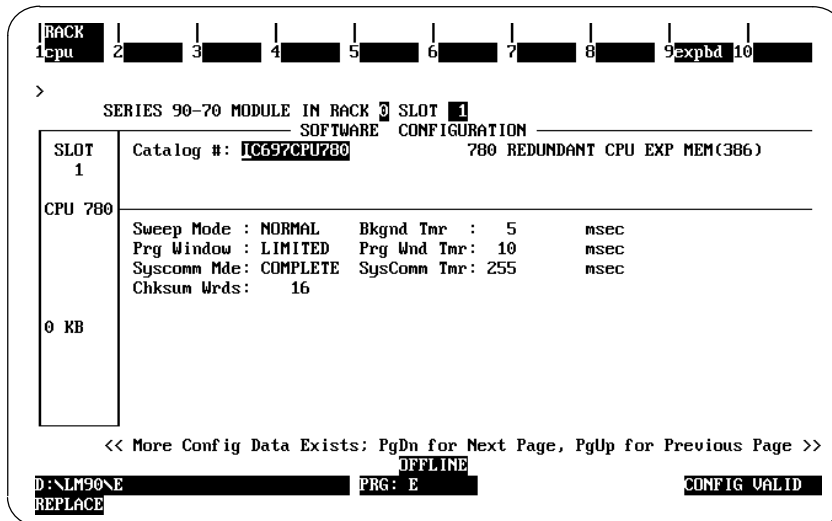

Constant Window Sweep Mode

To change the Sweep Mode, move the cursor to the Sweep Mode field and press the **Tab** key until the desired mode is displayed. Below is the detail screen (page 2) of a redundant CPU configured for CNST WND (constant window) sweep mode.

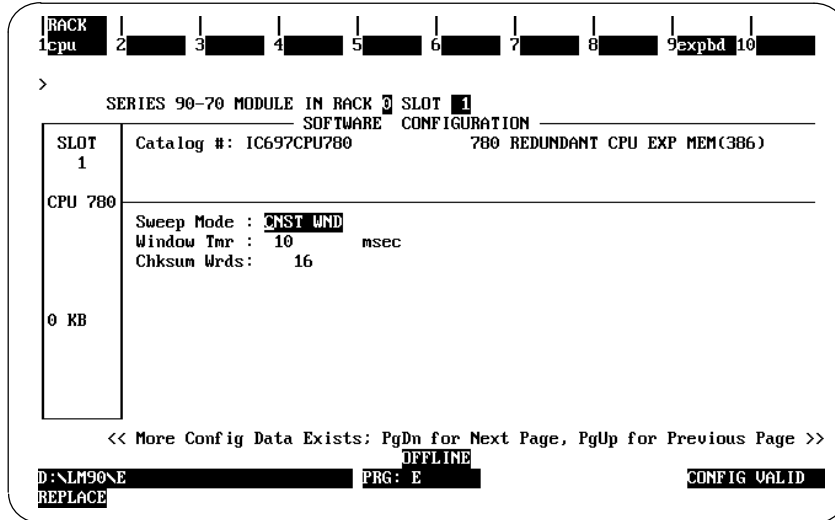

When a Series 90-70 redundant CPU is configured for CNST WND (constant window) mode, the window value will automatically be set to 10 msec.

Constant Sweep Mode

Below is the detail screen (page 2) of a redundant CPU configured for CNST SWP (constant sweep) mode.

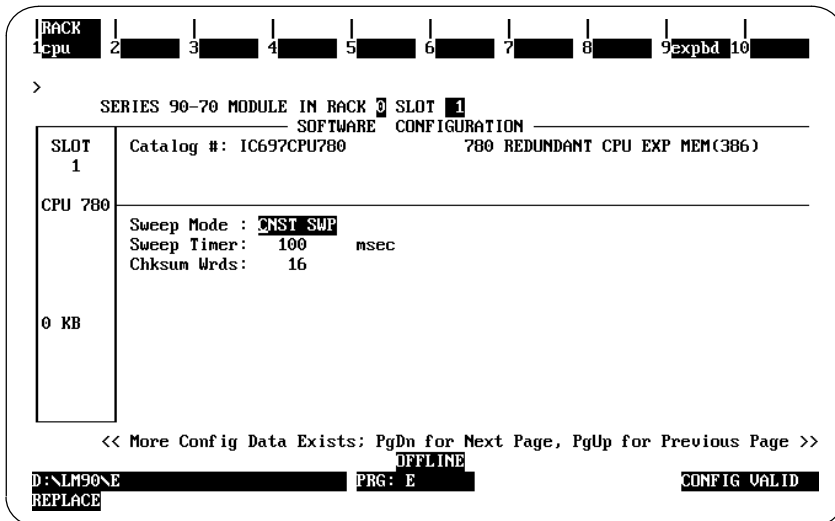

When a Series 90-70 redundant CPU is configured for CNST SWP (constant sweep) mode, its Sweep Timer value will automatically be set to 100 msec.

The screen shown below is the detail screen (page 3) of a redundant CPU module. This screen will not appear for non-redundant CPU modules, or when the redundant CPU is

set for SIMPLEX mode. The parameters on this screen are Ctrl Strgy (Control Strategy), Fail Wait and SHARED I/O.

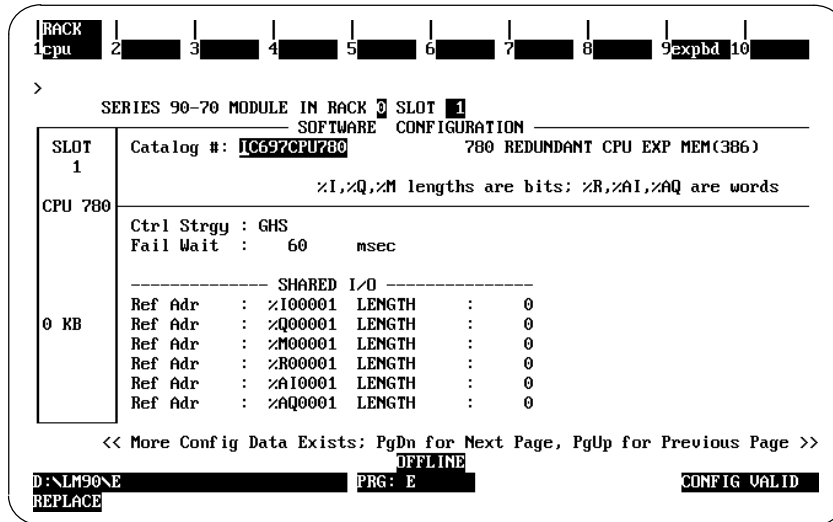

Ctrl Strgy

This parameter specifies which type of control strategy is selected for a redundancy system. The valid entry is three ASCII characters (A...Z). The only value that is supported at this time is *Genius* Hot Standby (GHS). If this parameter is set to any other value, the configuration will be considered valid, but any attempt to STORE the configuration will be rejected by the PLC. The default value is GHS.

Fail Wait

This parameter specifies the time one PLC will wait on one RCM link for the other PLC to respond before faulting that link. The Fail Wait range is 60 msec to 400 msec (measured in multiples of 10 msec) with the default value being 60 msec. The following table lists the two parameters described above.

Parameter	Description	Valid Values	Default Value
Fail Wait	Wait time	60 to 400 milliseconds in 10millisecond increments	60
ControlStrategy	Three character control strategy identifier	A.....Z	GHS

Shared I/O

The Shared I/O values are the reference addresses and ranges for the I/O references included in the 20 KBytes of Input data (%I, %AI) and 28 KBytes of Output data (%Q, %AQ, %M, %R) which is shared between the Primary and the Secondary units in the Hot Standby CPU Redundancy control system. The Shared I/O data is transferred from the active CPU to the backup CPU each sweep (refer to Chapter 4, "Synchronous Scan", for details). The valid entries for these parameters are described in the following tables.

Table 4. Shared I/O Data Parameters

I/O Parameter	Description and Valid Entries
%I Ref Adr	Starting address for redundant %I data region. Range is %I00001...%I12288. The starting address is bit aligned. Default value is %I00001.
%I LENGTH	The bit length of the redundant %I data region. Range is 0...12288. Default value is 0.
%Q Ref Adr	Starting address for redundant %Q data region. Range is %Q00001...%Q12288. The starting address is byte aligned. Default value is %Q00001.
%Q LENGTH	The bit length of the redundant %Q data region. Range is 0...12288. Default value is 0.
%M Ref Adr	Starting address for redundant %M data region. Range is %M00001...%M12288. The starting address is byte aligned. Default value is %M00001.
%M LENGTH	The bit length of the redundant %M data region. Range is 0...12288. Default value is 0.
%R Ref Adr	Starting address for redundant %R data region. Range is %R00001...%R configured limit or 8K, whichever is smaller (since only 28 Kbytes can be transferred). The %R memory limit for the CPU 780 is configurable in the PLC memory configuration screen. The maximum limit depends on the available CPU memory. See "Memory Configuration" later in this chapter. The default value is %R00001.
%R LENGTH	The word length of the redundant %R data region. Range is 0...%R configured limit. The default value is 0.
%AI Ref Adr	Starting address for redundant %AI data region. Range is %AI00000...%AI configured limit. The %AI memory limit for the is configurable in the PLC memory configuration screen. The maximum limit depends on the available CPU memory. The default value is %AI00001.
%AI LENGTH	The word length of the redundant %AI data region. Range is 0...%AI configured limit. The default value is 0.
%AQ Ref Adr	Starting address for redundant %AQ data region. Range is %AQ00000...%AQ configured limit. The %AQ memory limit for the is configurable in the PLC memory configuration screen. The maximum limit depends on the available CPU memory. The default value is %AQ00001.
%AQ LENGTH	The word length of the redundant %AQ data region. Range is 0...%AQ configured limit. Default value is 0.

Table 5. Shared I/O Reference Values

Parameter	Valid Values	Default Values
%I Ref Adr	%I00001...%I12288	%I00001
%I Length	0...12288	0
%Q Ref Adr	%Q00001...%Q12288	%Q00001
%Q Length	0...12288	0
%M Ref Adr	%M00001...%M12288	%M00001
%M Length	0...12288	0
%R Ref Adr	%R0001..configuredlimits	%R00001
%R Length	0...PLC memory limits	0
%AI Ref Adr	%AI0001..configuredlimits	%AI00001
%AI Length	0...configuredlimits	0
%AQ Ref Adr	%AQ0001..configuredlimits	%AQ00001
%AQ Length	0...configuredlimits	0

Transfer Data Size

The following table shows the amount of Shared I/O data transferred for each reference type. No more than 20 Kbytes of Input data and 28 Kbytes of Output data can be transferred (an additional 8 Kbytes is reserved for resynchronization transfers).

Note that the memory for the Shared I/O data that is stored at configuration must be subtracted from the amount of memory on the configured expansion memory module. The calculation for the size of the memory for Shared I/O data is (bytes of Input data transfer *plus* bytes of Output data transfer *plus* 8 Kbytes for synchronization information).

For example if the selected expansion memory is 512 Kbytes, and the Shared I/O data is 10 Kbytes of Input data transfer and 20 Kbytes of Output data transfer, then 10K + 20K + 8K Bytes = 38 KBytes is reserved for data transfers. This is subtracted from the 512 KBytes of available user memory (512K – 38K = 474K Bytes, which means that 474 KBytes is available for the user’s control program.

Table 6. Transfer Data Size

Reference Type	Reference Size	Calculation for Number of Bytes
<i>If point faults are DISABLED use the following calculations.</i>		
%I	Bit	(%I references x 4 bits/reference) ÷ 8bits/byte
%AI	Word	(%AI references x 2 bytes/reference)
%Q	Bit	(%Q references x 4 bits/reference) ÷ 8bits/byte
%M	Bit	(%M references x 4 bits/reference) ÷ 8bits/byte
%AQ	Word	(%AQ references x 2 bytes/reference)
%R	Word	(%R references x 2 bytes/reference)
<i>If point faults are ENABLED use the following calculations.</i>		
%I	Bit	(%I references x 5 bits/reference) ÷ 8bits/byte
%AI	Word	(%AI references x 3 bytes/reference)
%Q	Bit	(%Q references x 5 bits/reference) ÷ 8bits/byte
%M	Bit	(%M references x 4 bits/reference) ÷ 8bits/byte
%AQ	Word	(%AQ references x 3 bytes/reference)
%R	Word	(%R references x 2 bytes/reference)

Interrupts

Interrupts cannot be ENABLED for Input Modules or VME modules when the configured CPU is a CPU 780. The current configuration will be checked to ensure that there are no modules that have interrupts ENABLED. If modules do exist in the current configuration that have interrupts ENABLED and you configure a CPU 780, a prompt will appear asking whether or not all module interrupts should be DISABLED automatically. You cannot configure a Redundant CPU (CPU 780) until all module interrupts are DISABLED.

Configuring a CPU Expansion Memory Board

To configure a CPU expansion memory board for the CPU 780, press the **expbd** softkey (F9) and then the **memory** softkey (F1). Position the cursor on the desired expansion memory board and press **Enter** to select that board. The detail screen for the expansion memory board and the displayed catalog list for the available CPU expansion memory boards is shown below.

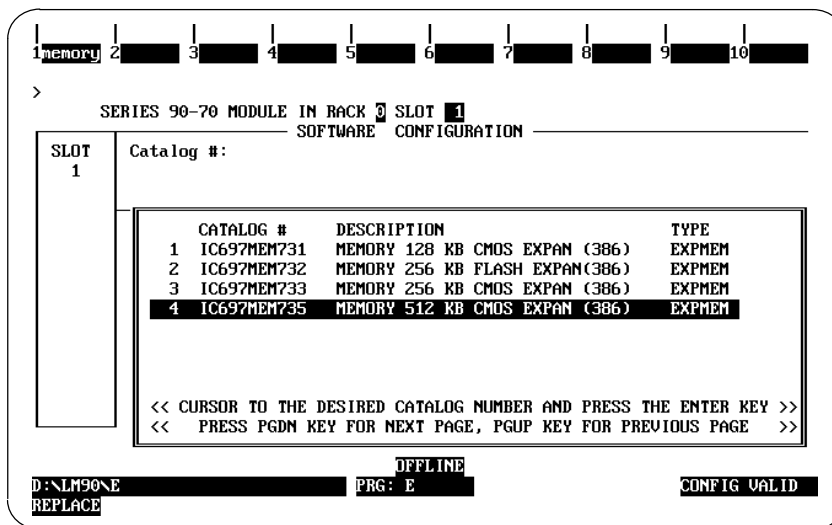

Press the **Esc** key twice to return to the Rack level display. The selected memory size is shown below the CPU model (CPU 780).

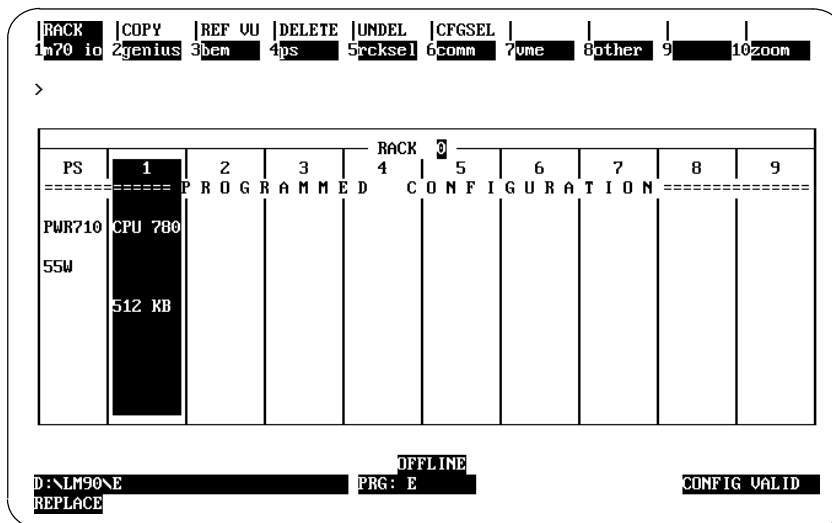

Configuration of a Redundancy Communications Module

As described previously, one Redundancy Communications Module (the Local unit) must be configured in rack 0 (can be in slots 2 to 9). There must not be an empty slot between the CPU 780 module and the RCM module. If there is an empty slot, the configuration will be invalid. The following example screens show an RCM configured in slot 2 in rack 0. While in the I/O Configuration rack screen, cursor to slot 2 (currently empty) as shown below.

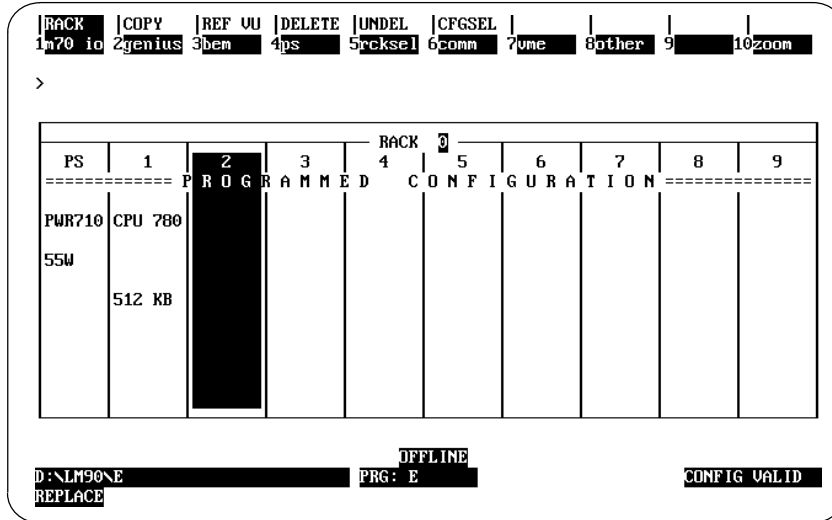

Select the **ben** softkey (f3) from the I/O Configuration rack screen, the following screen will be displayed:

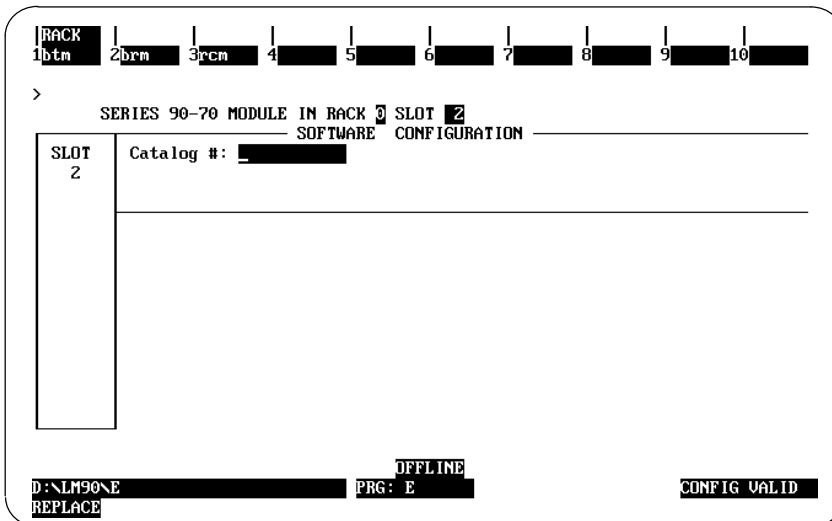

To display the RCM catalog list, press the **rcm** softkey (F3). The RCM catalog list is then displayed as shown below.

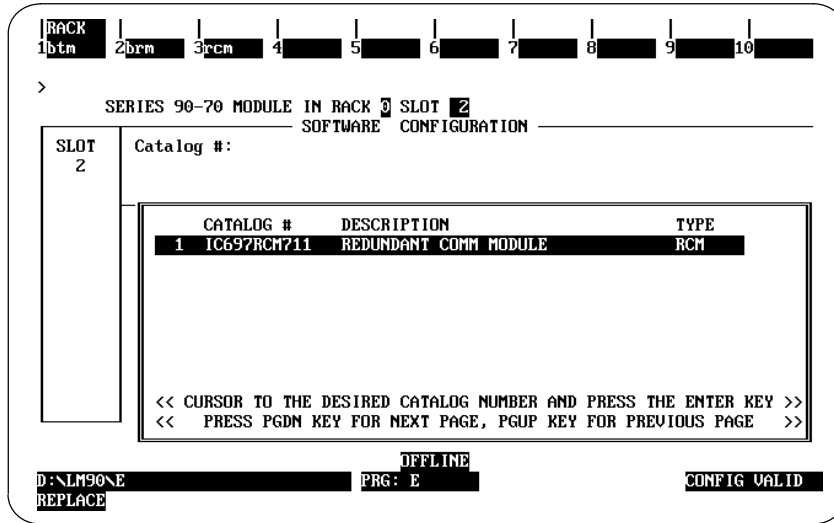

Next, press the **Enter** key, the following screen is displayed to confirm that you have selected the RCM catalog entry.

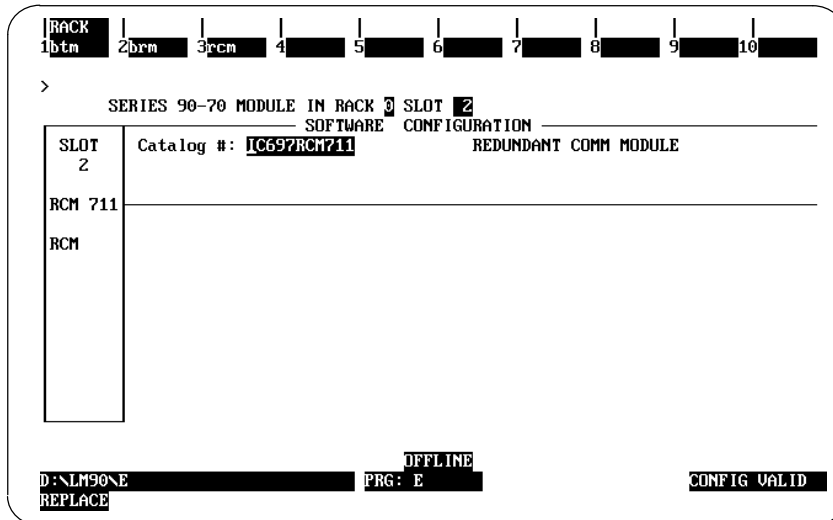

You have just configured the Local RCM in rack 0. The system automatically configures the RCM in the Secondary unit as being in slot 1 of rack 7 (in relation to the RCM you have just configured in the Primary unit).

Configuration of a Genius Bus Controller

For this example, assume that a Genius Bus Controller has been configured in slot 3 of rack 0. In a Hot Standby CPU Redundancy system, the Redundancy parameter (Redund Mode) of a Genius Bus Controller can only be NONE or RED CTRL; any other value is not valid. The following screen is the GBC screen when the Redund Mode parameter is set to NONE.

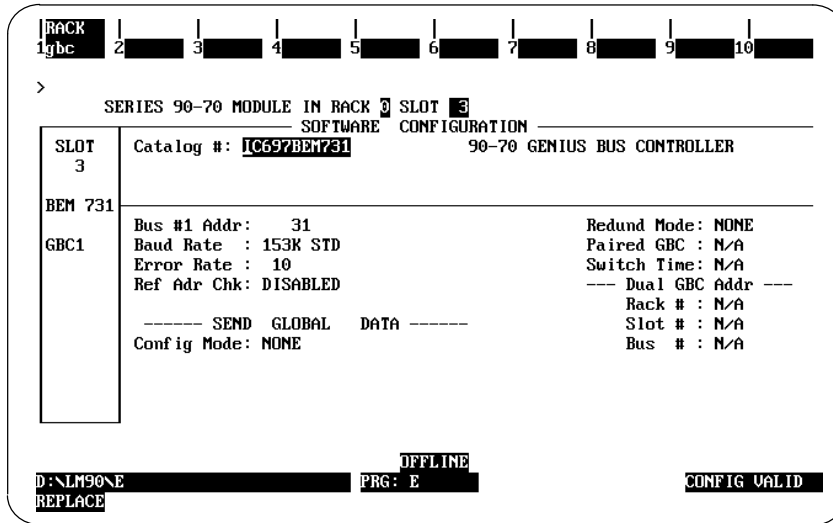

To change the Redund Mode, move the cursor to the Redund Mode field and press the Tab key until the desired mode is selected. When the Redund Mode parameter for the GBC is set to RED CTRL, the following screen is displayed:

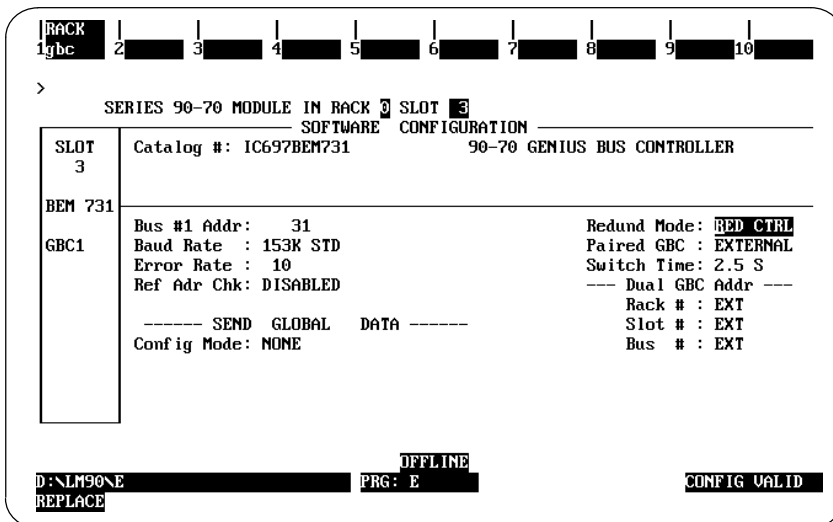

Paired GBC Parameter

When the GBC redundancy mode, **Redund Mode** is set to RED CTRL, the **Paired GBC** configuration parameter *MUST* be set to EXTERNAL. This is automatically done by the system.

Serial Bus Address

All redundant GBCs in the Primary CPU redundant system *MUST* be configured at SBA 31. In the sample screen on the previous page, the rack level GBC is configured at SBA 31. The Bus level GBC is automatically configured at SBA 30.

All redundant GBCs in the Secondary CPU redundant system *MUST* be configured at SBA 30. In our example, the rack level GBC is configured at SBA 30. The Bus level GBC is automatically configured at SBA 31

All of the Genius I/O blocks on the bus of a redundant GBC in a Hot Standby CPU Redundancy system *MUST* be set Redundant.

Note

For fastest switching, all Genius Bus Controllers in the Hot Standby CPU Redundancy system should be in the main rack, or in a rack driven by the main rack's power supply. This will cause the Genius Bus Controller to lose power at the same time that the CPU loses power and allow the backup unit to gain full control of the I/O as soon as possible.

Configuring a Primary Redundant PLC

The steps required for configuring a Primary Redundant PLC are described below. The Primary PLC and the Secondary PLC must be configured separately. An example of the configuration screens for each system is provided on the following pages. *The programmer must be connected to the CPU in the Primary PLC to configure the Primary PLC and then moved to the CPU in the Secondary PLC to configure the Secondary PLC.* First, the Primary PLC will be configured.

While in the Configuration Software main menu, select I/O (F1). The default configuration for the I/O Configuration Rack screen is displayed.

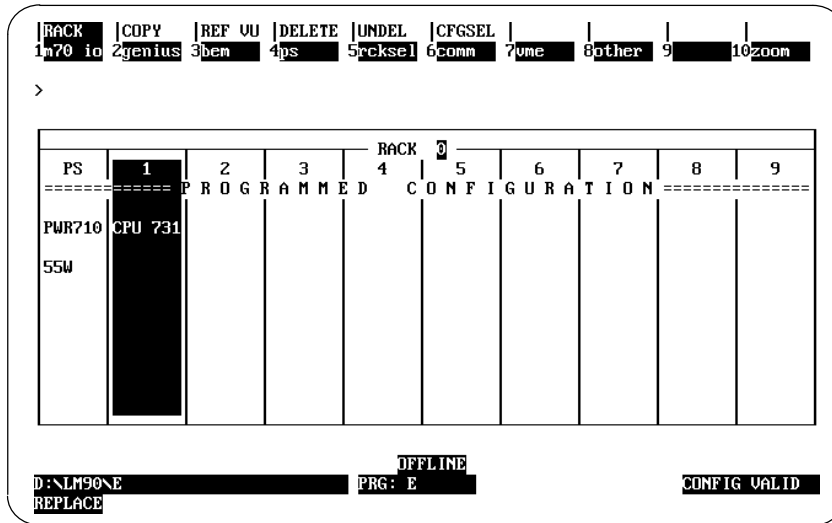

Position the cursor on rack 0, slot 1 and press the **zoom** softkey (F10) to zoom into the CPU module currently configured in slot 1. Press the **cpu** softkey (F1) to have a catalog list of the available CPU modules displayed. The currently selected CPU is highlighted in reverse video.

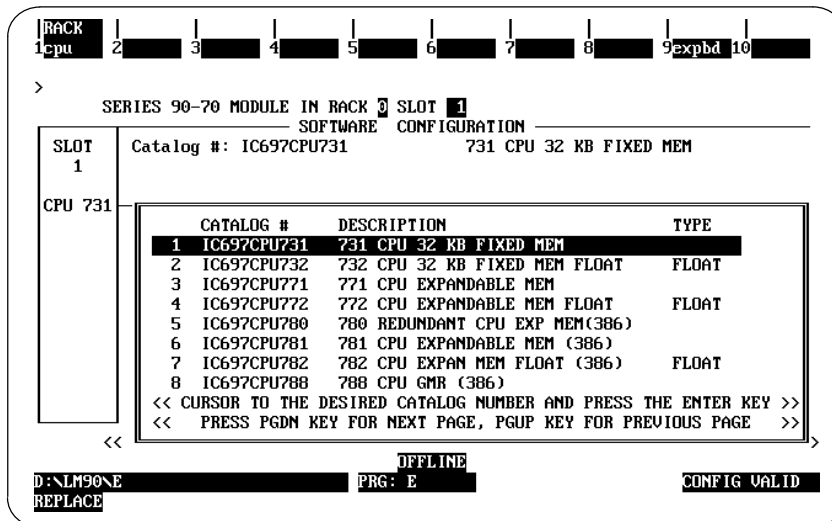

Select the Redundancy CPU Module

Move the cursor to the line for the Redundant CPU, IC697CPU 780, and press the **Enter** key. A message is displayed beneath the softkey selection strip: "REPLACE displayed module? (Y/N)". Press the Y key to replace the currently displayed CPU with the CPU 780. The detail screen (page 1) for the redundancy CPU module is displayed.

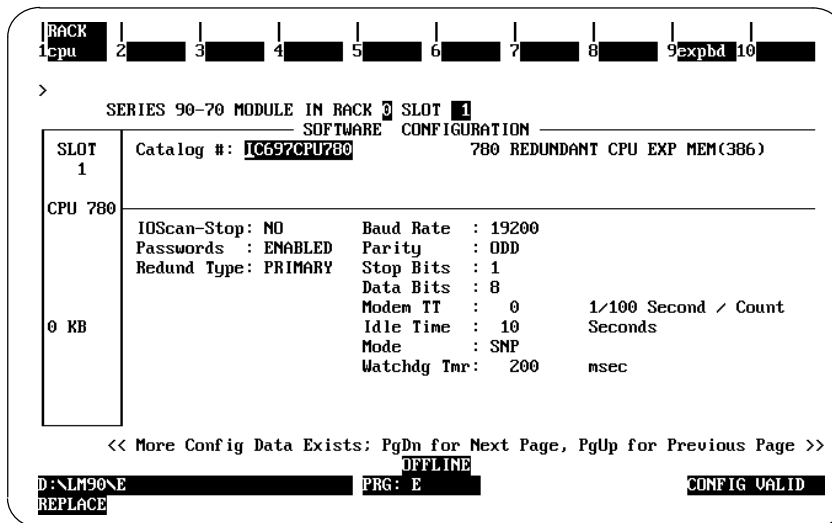

Press the PgDn (page down) key to go to the next page of the CPU module. The default screen for page 2 is as follows:

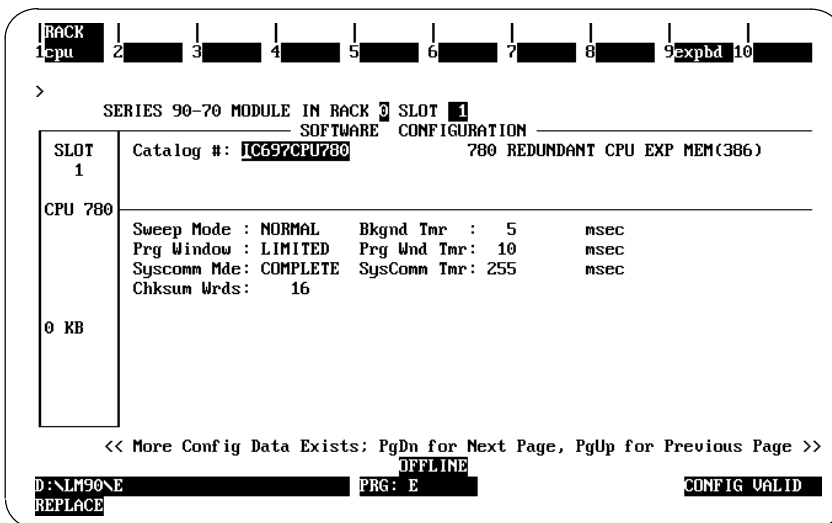

Press the PgDn key again to go to the next page of the CPU module. The default screen for page 3 of the CPU detail screen appears as shown below:

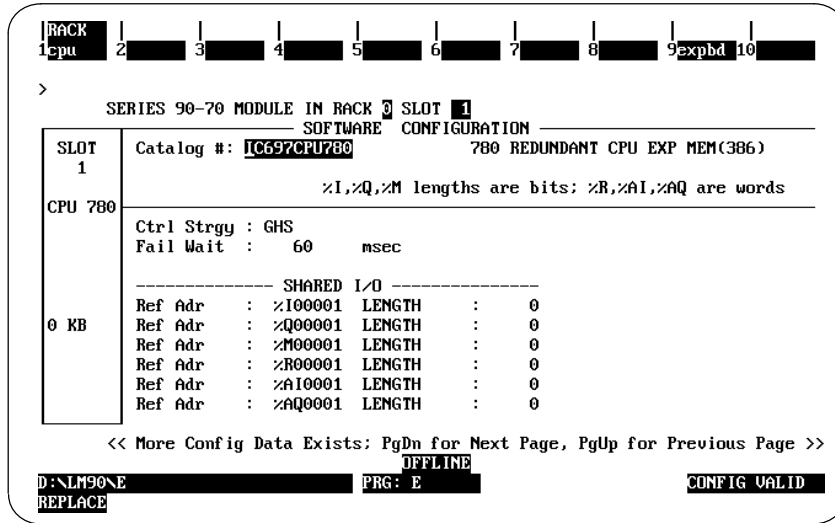

Select an Expansion Memory Board

To configure a CPU expansion memory board for the CPU 780, press the **expnd** softkey (F9), then the **memory** softkey (f1). The detail screen for selection of the expansion memory board with the catalog list of the CPU expansion memory modules appears as follows: Position the cursor on the desired memory board and press **Enter**.

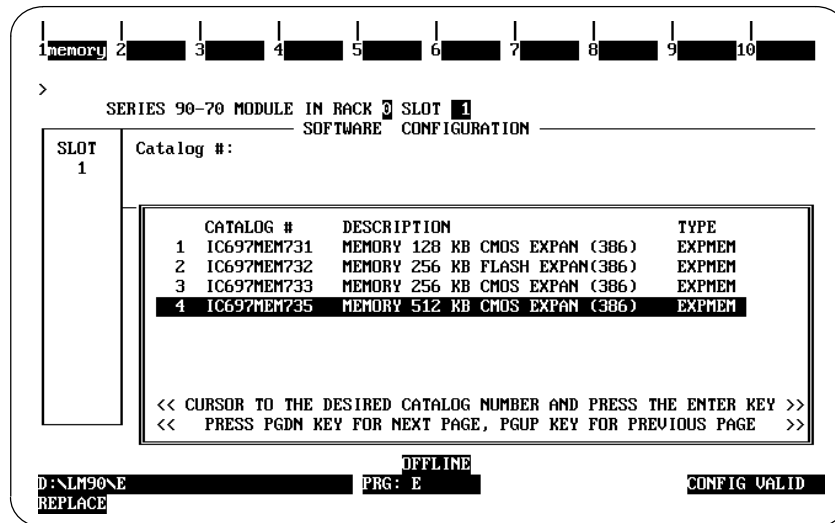

Press the **Esc** key twice to return to the rack level display, which now appears as shown below.

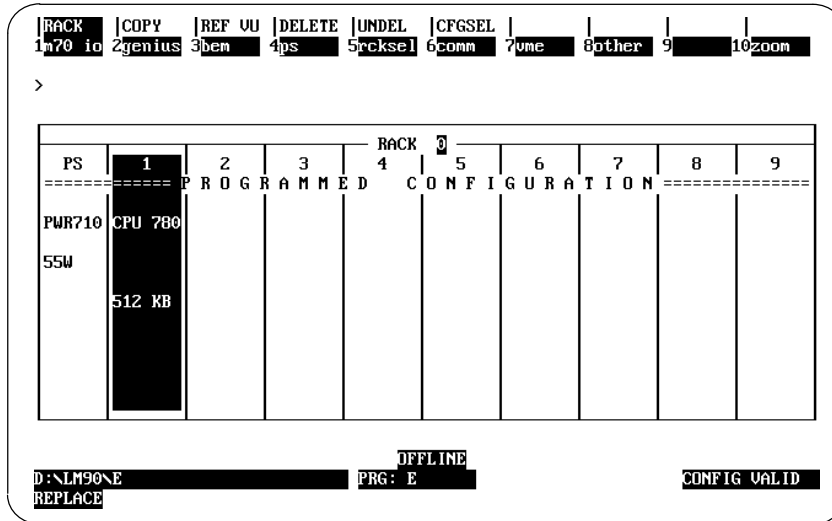

Configure the Redundant Communications Module

To configure an RCM in rack 0, slot 2, move the cursor to slot 2 and press the **bem** softkey (F3). The configuration screen for bus communication modules will appear. From this screen press the **rcm** softkey (F3). The catalog list screen for the RCM module will be displayed. Press the **Enter** key to select the RCM module, IC697RCM711. The RCM module detail screen appears as follows:

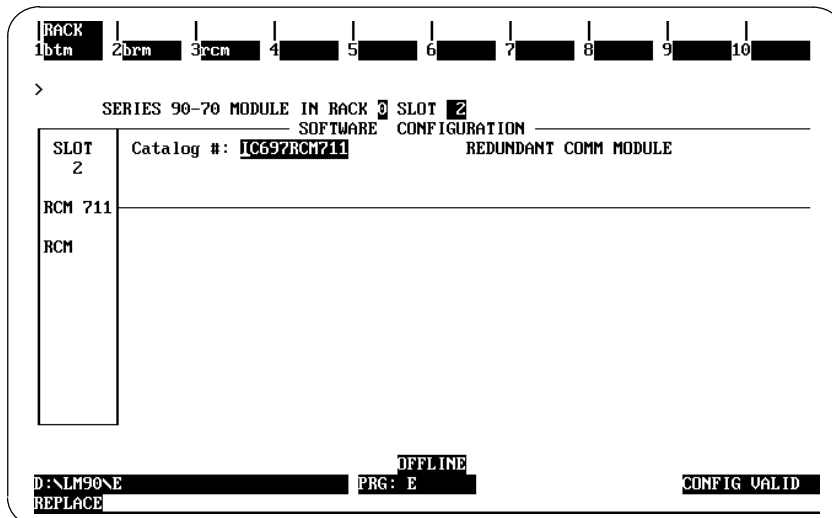

Press the **Esc** key to return to the rack level screen.

Configure a Genius Bus Controller

To configure a Genius Bus Controller module in rack 0, slot 3, position the cursor on slot 3 and press the **genius** softkey (F2). To display the catalog list for the Genius Bus Controller, press the **gbc** softkey (F1). Press the **Enter** key to select the Genius Bus Controller module. The Genius Bus Controller detail screen will then be displayed as shown below.

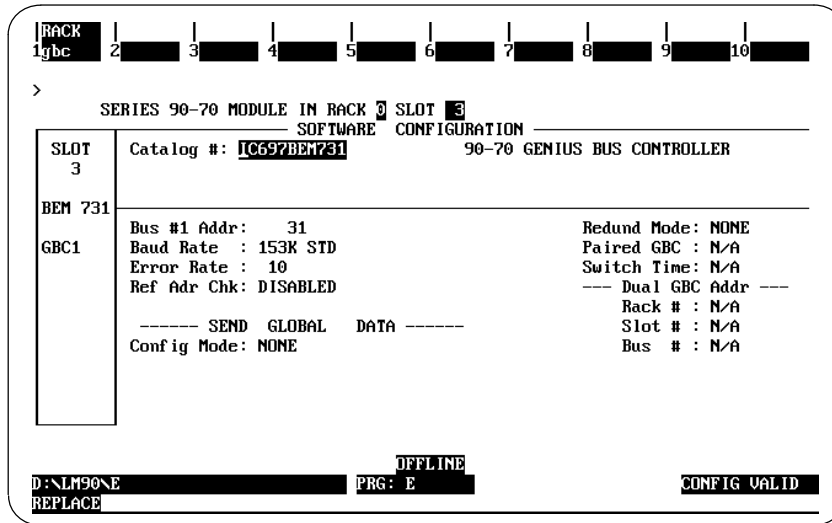

To change the Genius bus redundancy mode for redundancy, move the cursor to **Redund Mode**: Press the **Tab** key until the value for the field changes to **RED CTRL**. Note that in a Hot Standby CPU Redundancy system, the only values that are valid for this parameter are NONE or RED CTRL.

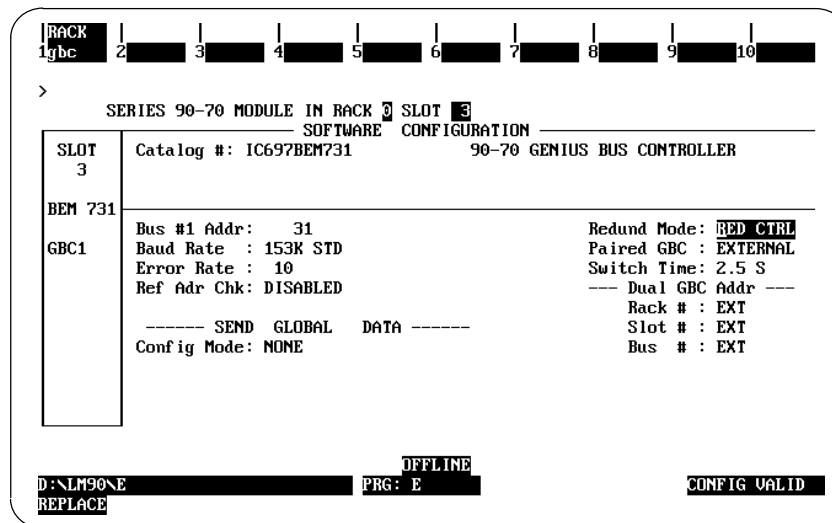

At this point, Press the **Esc** key and the bus screen will appear as shown below.

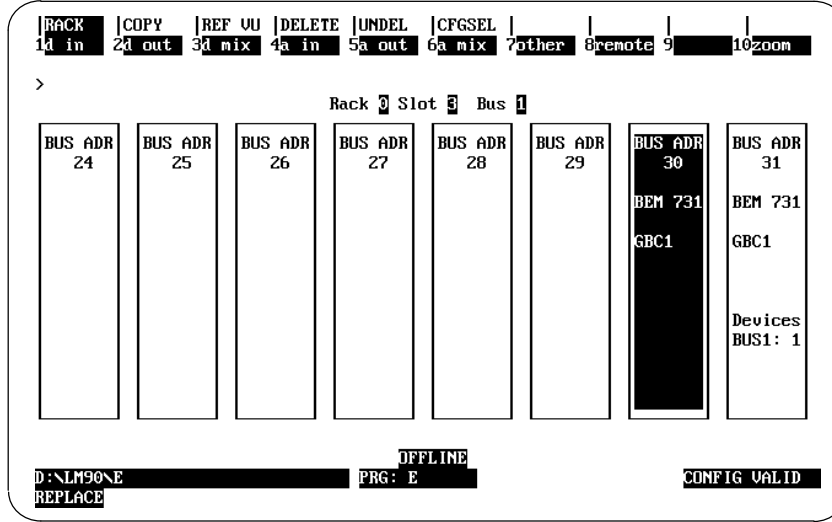

Configure Genius I/O Blocks

We will now configure a block for Bus Address 29. Move the cursor to block 29 and configure a bus block (Discrete Input block IC660BBD110 for this example) by selecting the F1 function key (**d in**), then **Enter**. The bus block's detail screen will appear as shown below.

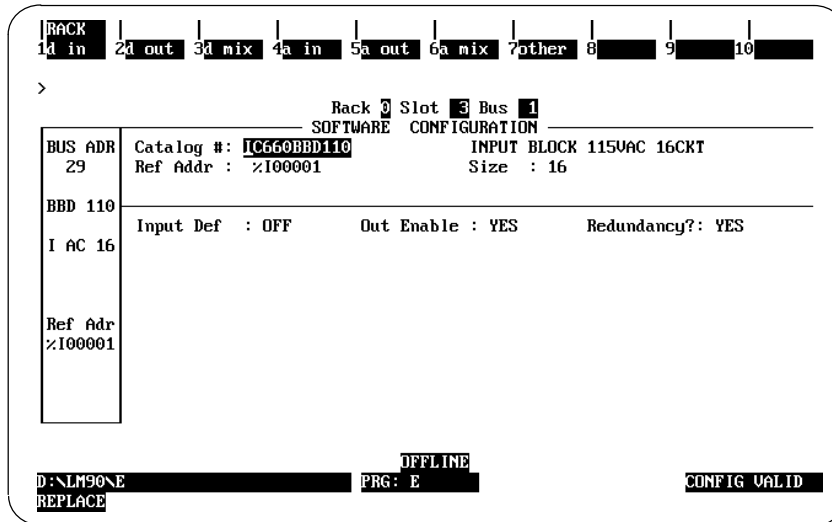

The *Redundancy?* parameter at the middle right of the screen is based on the Redund Mode that was selected for the Genius Bus Controller. At this point, you may configure the required type and number of blocks on the Genius bus.

When you have completed configuring Genius blocks, press the **Esc** key to go from the block level display back to the bus level display. The bus display will now appear as shown below.

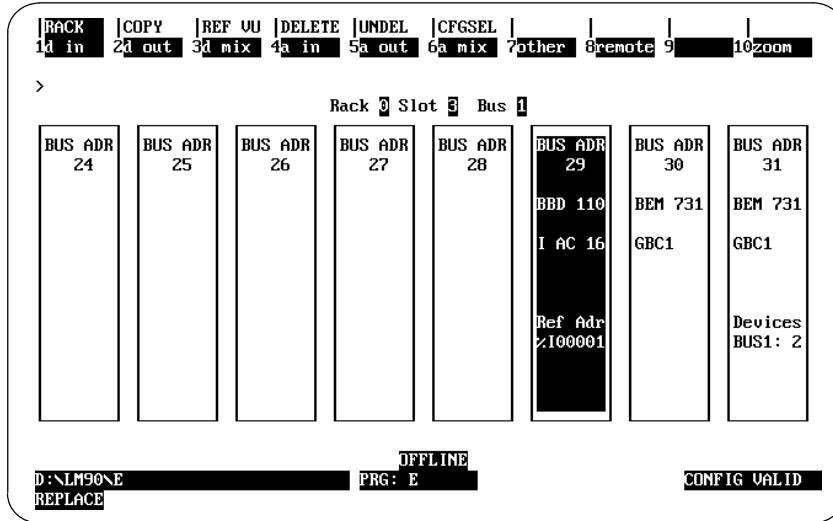

Configure the Bus Transmitter Module

Press the **Esc** key to return to the rack level display. A message will be displayed reminding you to configure a Bus Transmitter Module for this rack (since it had not been configured earlier). Press **Esc** again. Move the cursor to slot 4, press the **bem** softkey (F1), then press the **btm** softkey (F1) to select the Bus Transmitter Module, and press **Enter**. The detail screen for the Bus Transmitter Module will appear.

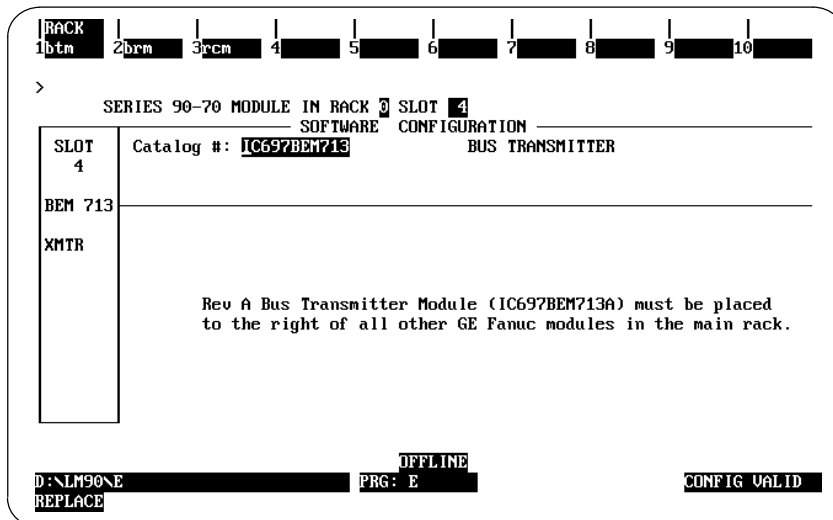

Press the **Esc** key which will return you to the rack level display. At this point you have completed the necessary configuration steps for the Primary PLC and can proceed to configuring the Secondary PLC.

Configuring a Secondary Redundant PLC

This section describes the steps for configuration of a Secondary PLC. The programmer for Logicmaster 90-70 software must be connected to the Secondary PLC in order to configure the Secondary PLC. There are several ways to configure a Secondary PLC in a Hot Standby CPU Redundancy system. One method is shown here.

Create a new folder for the Secondary PLC system. Copy the data from the Primary PLC system to the Secondary PLC system folder. This process will save time since you will not need to re-enter the configuration parameters that are common to the two redundancy systems.

This example shows how to change the Primary PLC redundancy configuration described on the previous pages to a Secondary PLC redundancy.

Enter the I/O Configuration software by pressing the I/O softkey (F1). The configuration for rack 0 appears as shown below (note that this is the configuration that you had selected for the Primary PLC)

The screenshot shows the I/O Configuration software interface. At the top, there is a menu bar with options: RACK, COPY, REF UU, DELETE, UNDEL, CFGSEL, and a numeric keypad (1-10). Below the menu bar, a right arrow (>) is visible. The main display area shows a table for RACK 0 configuration. The table has columns for PS, 1, 2, 3, 4, 5, 6, 7, 8, and 9. The title of the table is 'PROGRAMMED CONFIGURATION'. The data in the table is as follows:

PS	1	2	3	4	5	6	7	8	9
PWR710	CPU 780	RCM 711	BEM 731	BEM 713					
55W		RCM	GBC1	XMTR					
	512 KB		Devices						
			BUS1: 2						

At the bottom of the screen, there is a status bar with the following information: 'D:\LM90\E', 'REPLACE', 'OFFLINE', 'PRG: E', and 'CONFIG VALID'.

Position the cursor on rack 0, slot 1. Press the **zoom** softkey (F10) to zoom into the CPU module configured in slot 1. The detail screen (page 1) for the CPU module appears as shown below:

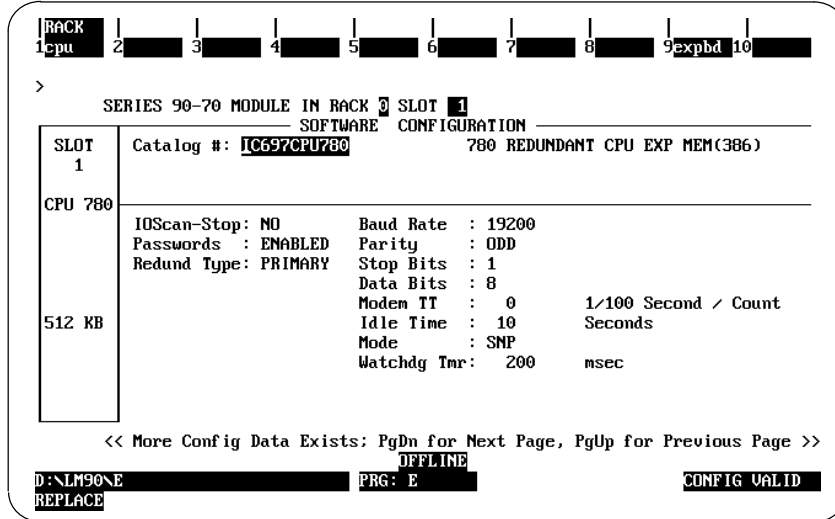

Change Redund Type

Change the **Redund Type**: parameter value from **PRIMARY** to **SECNDARY** by pressing the **Tab** key then the **Enter** key. The message "SBAs of all redundant GBCs in a secondary system must be 30: modify (Y/N) ?" will be displayed. Press "Y" at the prompt. At this time, the SBAs of all redundant rack level GBCs will be changed to 30 and the SBAs of their corresponding bus level GBCs will be changed to 31. After the changes have been made, the screen will appear as follows:

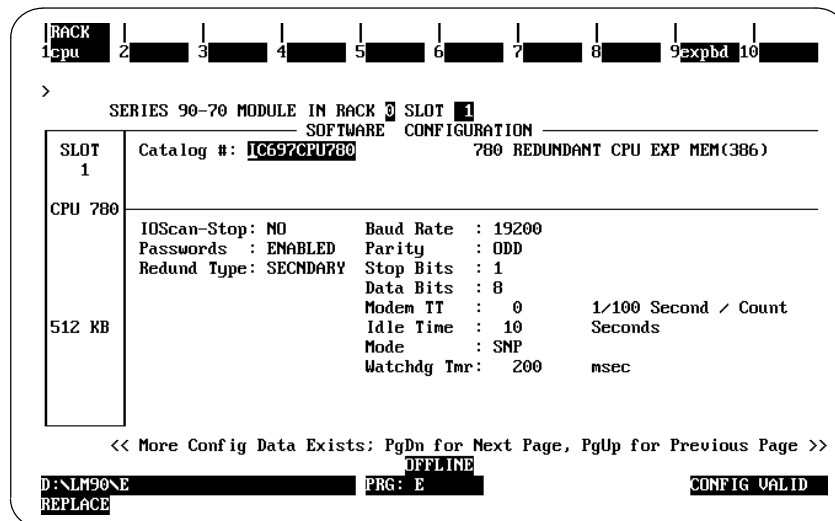

Press the **Esc** key twice to save the changes you have just made. This completes the process of converting a Primary PLC redundancy system configuration to a Secondary PLC redundancy system configuration. The differences between the Primary system and the Secondary system are:

1. The CPU module parameter **Redund Type** in a Primary system is PRIMARY and in a Secondary system is SECNDARY.
2. The Serial Bus Address (SBA) of a redundant GBC in a Primary system MUST be 31 and in a Secondary system MUST be 30.

The Genius Bus Controller bus level display in a Secondary PLC redundancy system is as shown below.

RACK		COPY		REF UU		DELETE		UNDEL		CFGSEL							
1d in		2d out		3d mix		4a in		5a out		6a mix		7other		8remote		9	
10zoom																	
>																	
Rack 2 Slot 3 Bus 1																	
BUS ADR		BUS ADR		BUS ADR		BUS ADR		BUS ADR		BUS ADR		BUS ADR		BUS ADR		BUS ADR	
24		25		26		27		28		29		30		31			
										BBD 110		BEM 731		BEM 731			
										I AC 16		GBC1		GBC1			
										Ref Adr		Devices					
										%100001		BUS1: 2					
OFFLINE																	
D:\LM90E						FRG: E						CONFIG VALID					
REPLACE																	

Chapter 4

Operation

This chapter discusses:

- the normal operation of a Hot Standby CPU Redundancy PLC system;
- what happens when a fault is detected and the system does not operate normally;
- how to restore the system to normal operation;
- on-line repair procedures.

Section 1 describes normal system operation of a Series 90-70 Hot Standby CPU Redundancy system, Section 2 describes what happens when a system failure is detected, the actions taken by the system in response to detected faults and how to restore the system to normal operation.

Section 5: System Operation

Power-Up Sequence of a Redundant CPU

When a CPU is powered up, it will perform a complete hardware diagnostic check and a complete check of the user program and configuration parameters. This will cause the power up time of a redundant CPU to be significantly longer than the normal power up time of a simplex (non-redundant) Series 90-70 CPU. If the Primary and Secondary systems are powering up together each CPU must recognize this fact so that the Primary system will become the active and the Secondary system the backup.

The following sequence outlines each step in the power-up process. The only difference in this sequence as compared to the power-up sequence of existing CPUs is that *full power-up tests are always performed* instead of conditionally depending on whether *STOP* mode is selected, and the detection of the other CPU along with initialization of each RCM followed by synchronization.

1. Power-up self-test is performed.
2. CPU operating system is initialized and PLC memory is validated.
3. Diagnostics called for "Full" power-up tests performed.

4. System Configuration verified.
5. System interrogated and initialized.
6. Presence of other CPU detected and RCMs initialized.
7. Complete user program verification.
8. Synchronize with the Redundant CPU.

When powering up the unit configured as the Secondary Unit in a Redundant system and no remote unit (the Primary Unit) is detected, the Secondary Unit will wait up to 15 seconds to see if the remote unit will also power up. If after 15 seconds, the remote unit has not completed its power up sequence, then the Secondary Unit will assume that no remote unit is present. If at this time, the Secondary Unit transitions to RUN mode, it will do so as a stand-alone unit.

If the unit configured as the Primary Unit completes its power-up sequence before the remote unit (the Secondary Unit) the Primary Unit does not wait for the remote unit to complete its power-up sequence. If the Primary Unit is setup to transition to RUN on power-up (that is, was powered-down in RUN mode), it will transition to a stand-alone unit without waiting for the remote unit. When the remote unit completes its power-up sequence, it will attempt to establish communications with the Primary Unit and will synchronize if also transitioning to RUN mode.

In either case, if one CPU fails to notify the other CPU that it is either present or powering up, this CPU will proceed to power-up as a stand-alone CPU and will become the active CPU. The other CPU will resynchronize once the power-up sequence is complete.

Note

In applications where it is desired to have a fully redundant system upon power-up, the Secondary Unit must complete power-up first but no more than 15 seconds before the Primary Unit. The way to be sure that this happens is to apply power to the Secondary Unit first.

Incompatible Configurations

When two units have incompatible configurations stored (for example, both units configured for PRIMARY or differing blocks for data transfer), then only one of the units can go to RUN mode. If the other unit attempts to go to RUN mode or both units attempt to go to RUN mode at the same time, a FATAL incompatible configuration fault will be logged.

If one unit is configured for CPU Redundancy and the other has no configuration, then both units may go to RUN mode at the same time *but* they will not be synchronized and only the unit that has been configured will drive outputs.

Resynchronization of the Redundant CPU

Whenever a CPU is attempting to get back in synchronization with the currently active CPU, a resynchronization process will occur. This resynchronization process will occur any time a CPU performs a STOP to RUN mode transition. This process will start by determining which role each CPU is to play. The Primary Unit (with Serial Bus Address 31) is always preferred and a switch will occur from the Secondary Unit anytime the primary CPU performs a resynchronization. However, until the resynchronization is complete, the primary CPU will play the role of the backup. The Primary unit will switch to active just *prior* to logic execution. Outputs will be driven that sweep by the primary unit.

If both systems are transitioning at the same time, then the primary CPU will become the active CPU and the secondary will become the backup.

During the resynchronization process, data is exchanged between the CPUs regarding roles and configuration. If the transitioning CPU detects that the role or configuration is not in agreement, then that CPU will not be permitted to go to RUN mode. If both CPUs are transitioning, then neither CPU will be permitted to go to RUN mode. The following items must be in agreement:

1. One CPU must be configured as Primary, the other as Secondary.
2. Both CPUs must be configured for the same redundancy scheme; but not necessarily the same release.
3. Both CPUs must have the same Shared I/O redundancy points configured.
4. Point fault configuration must match. If point faults are configured on one CPU, they must also be configured on the other if %I, %Q, %AI, or %AQ data is transferred.

At this point, the active unit is the one that has been in control and the backup unit is the one that is resynchronizing. The transfer of all configured control data from the active unit to the backup will occur provided both units are not transitioning at the same time (the transfer always goes from the running unit to the resynching unit. In addition to the configured control data, the FST_SCN and FST_EXE %S references as well as internal timer information for each common (that is, present in both CPUs) sub-block are transferred from active to backup. Only the internal timers and FST_EXE references for program blocks with the same name will be transferred from the active to the backup CPU. The result of this is that if one CPU is already on-line and the other is transitioning to RUN mode, its FST_SCN and matching FST_EXE bits **will not** be set on its first scan. These bits are considered system bits and will only be set if one unit comes up alone, or if both units come up together.

No transfer of data occurs at this point if both units are transitioning. Instead, the normal clearing of non-retentive data will happen and the FST_SCN and FST_EXE references will be set as in the non-redundant simplex CPU models.

The timer information and the FST_EXE %S reference bits will not be continuously transferred. The timer information and FST_EXE references will be transferred only at resynchronization time and the timer information will be calculated each sweep from the universal "Start of Sweep Time" that is transferred every sweep.

Hot-Standby Redundancy Control Strategy

In the Hot-Standby Redundancy Control Strategy, the primary CPU (designated by all GBCs addressed at bus address 31), is always the preferred CPU. The secondary CPU (designated by all GBCs addressed at bus address 30) will have the outputs enabled to its GBCs at all times whether it is in control or not. This is necessary to prevent glitching of the outputs when a switch is made. The primary CPU on the other hand must disable its outputs whenever control is manually switched to the backup CPU and then re-enable them if it is again selected as the active unit. Glitching of the outputs will not occur on a switch from the secondary to the primary CPU when it is done manually but may occur if the switch is made automatically due to a failure in the secondary CPU.

For this reason, the primary CPU should normally be selected as the active unit. Anytime the primary CPU performs a *STOP to RUN* mode transition, the primary CPU will assume control from the secondary CPU after a resynchronization has occurred. This will be done automatically by the control strategy firmware in the PLC CPU.

The primary unit in the hot-standby control strategy will become a functioning backup if control is manually switched to the secondary unit. The system will remain with the secondary unit as the active unit and the primary unit as the backup until either another manual switch is commanded or either unit performs a *STOP to RUN* mode transition. A *STOP to RUN* mode transition always occurs when the unit is power cycled and proceeds directly to *RUN* mode or when commanded to transition by either the programmer or the toggle switch. A failure of the secondary unit while it is active may result in a glitch in the outputs.

To further clarify the above operation – when a resynchronization occurs for any reason, the primary unit will become active. However, in order for resynchronization to occur, one of the units *must* go to *STOP* mode and then back to *RUN*. If the secondary unit goes to *STOP*, the primary unit will then become the active unit.

The control strategy is selected during configuration of the Redundant CPU. The Control Strategy parameter is indicated by a three ASCII character identifier. For Hot Standby CPU Redundancy this identifier is GHS. Although other values may be selected and considered valid, any attempts to *STORE* them to the PLC will be rejected since GHS is currently the only valid Control Strategy. GHS is the default value for the Control Strategy parameter. For more information on selecting Redundancy CPU parameters, refer to Chapter 3, Redundancy System Configuration.

Synchronous Scan

The figure below shows the sweep components for the active and the backup CPUs. It shows the two communication points in the sweep. The *first communication point* is immediately after the inputs are scanned. At this point in the sweep the newly read inputs are sent from the active CPU to the backup CPU and synchronization information is passed. In the *second communication point*, the rest of the data (outputs, internal references, registers) is sent from the active PLC to the backup.

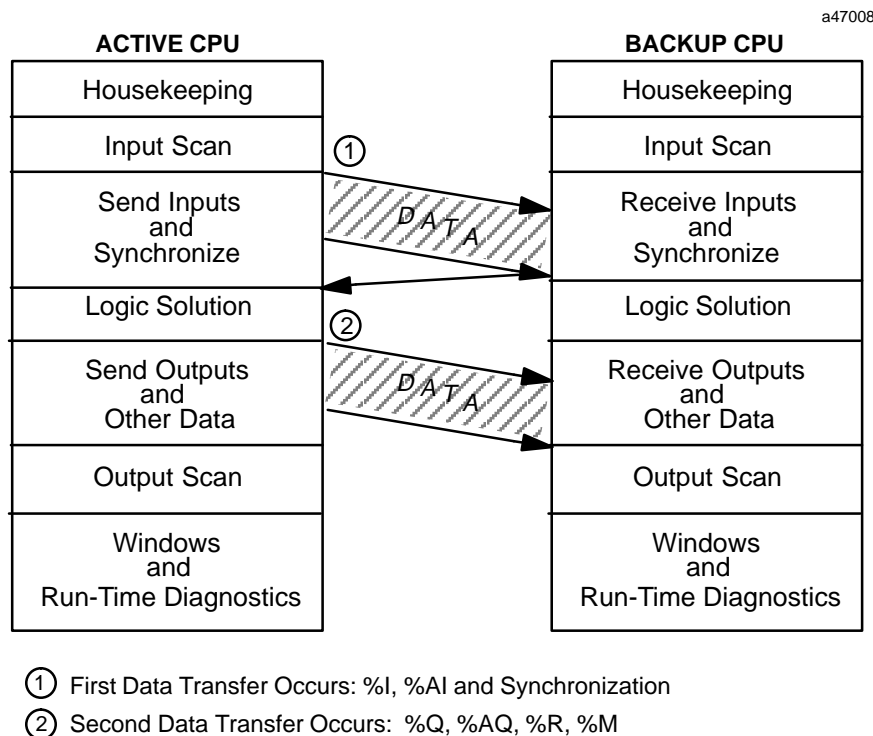

Figure 8. Active and Backup Sweeps

First Data Transfer %I, %AI and Synchronization

There are two points in the sweep where the active CPU will transfer data to the backup unit. The first data transfer will occur immediately after the Input Scan has occurred. The active unit will send all of the configured input data, both discrete (%I) and analog (%AI), to the backup unit. For discrete data, the status, override, and transition information is all transferred; if point faults are configured, point fault data is also sent. This data will overwrite the current input data in the backup unit.

In addition to the input data transfer, a synchronizing message containing the "Start of Sweep Time" will be sent from the active unit to the backup unit as soon as the input data has been transferred. The CPU's will stay in synchronization because the active unit will wait on the backup CPU to respond to the synchronizing message before starting its sweep.

The transfer of the redundancy data during each sweep will be in blocks with each block checked for data integrity. The transferred data will be held in a temporary area by the backup CPU until all data has been received and verified from the active unit. Then the backup CPU will copy that data from the temporary area to the actual PLC memories. The transfer is capable of being performed on either RCM link. If one RCM link fails then the transfer will switch to the other RCM without causing a loss of synchronization in the system. If at any time during a transfer the active unit fails or the full transfer fails to complete properly (both RCMs fail) then the backup unit will disregard the data that has been transferred to the temporary area and proceed with the values it already obtained during its input scan.

The last part of the input data transfer is the synchronizing message containing the "Start of Sweep Time". The "Start of Sweep Time" is the universal start of sweep time for the redundancy system. Normally each PLC CPU operates its elapsed time clock on which timers are based independently and the clocks are always started over from zero on a power cycle. Two independent clocks would cause time discontinuity at switch over time. In addition the clocks will tend to drift from each other over time. The redundancy system corrects for this by keeping a single elapsed time value for the entire redundancy system. The time will be continuous as long as one of the two systems continue to run and the active unit will continuously pass the time to backup unit to correct for any natural drift in the clocks. When a switch over occurs, the same time will continue to be kept in the new active unit.

Data Transfer from Backup Unit to Active Unit

Eight bytes (4 registers) of data can be transferred from the backup unit to the active unit during the input data transfer before the logic solution. To initiate this transfer, the backup unit executes SVCREQ #27 (Write to Reverse Transfer Area) to copy eight bytes of data from the reference specified by PARM to a temporary buffer (SVCREQ #27 on the active unit will have no effect). This transferred data will be stored in a temporary buffer on the active unit.

In the active unit, SVCREQ #28 (Read from Reverse Transfer Area) is then executed to copy the eight bytes of data from the temporary buffer to the reference specified by PARM (SVCREQ #28 will have no effect on the backup unit).

Note

There is always a one sweep delay between sending data to the active unit using SVCREQ #27 and reading the data using SVCREQ #28 on the active unit.

This data copied from the buffer is not valid

- during the first scan after either unit has transitioned to RUN;
- while the backup unit is in STOP mode;
- if the remote unit does not issue a service request to the sending unit.

An example of this data transfer is described below.

This data should not be used if REM_RDY is off or if REM_RDY is transitioning to on.

If the following two rungs are placed in the program logic of both units, the backup unit will send %P0001 through %P0004 to the active unit. The active unit will read the data into %P0005 through %P0008. %P0001 through %P0004 on the active unit and %P0005

through %P0008 on the backup unit will not change. %T0002 will be set whenever the operation is successful and the data can be used.

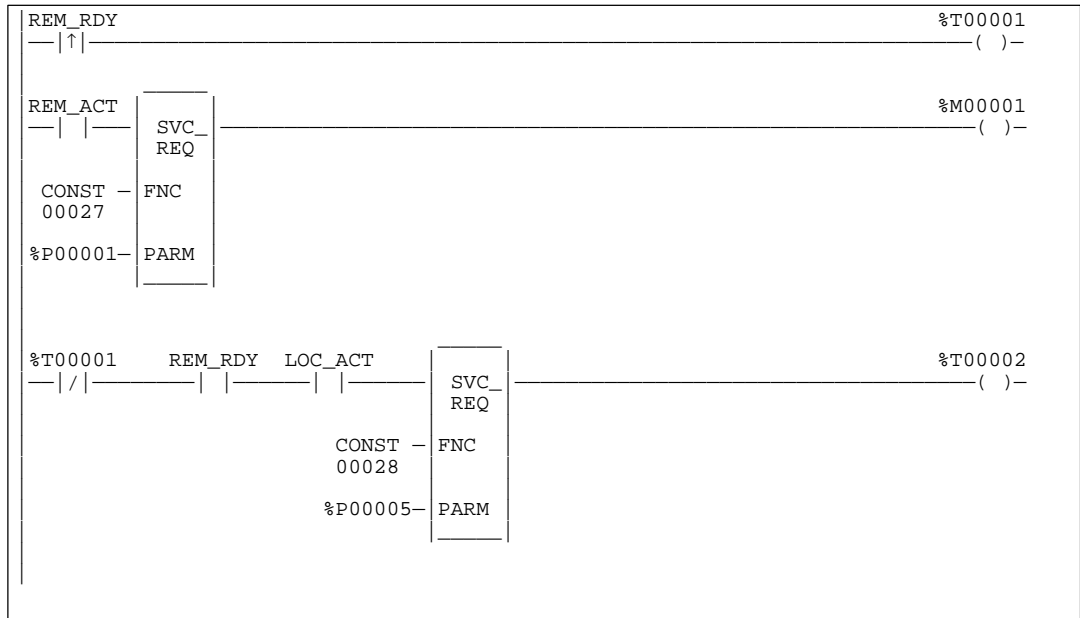

Second Data Transfer %Q, %AQ, %R, and %M

Both CPUs will then proceed independently until the end of the logic solution before the output scan begins. At this time the second data transfer will take place. In this data transfer, all remaining control data (as configured) will be transferred from the active unit to the backup unit. This includes the %Q, %AQ, %R, and %M memories, and point fault data that has been configured. As with the input data, the backup unit will hold all data until it is all received and verified before transferring it to the actual PLC memories.

After this second data transfer has been completed, both the active and the backup CPU will then proceed to perform their output scans and run their programmer and system communication windows independently of each other. Any remaining time for the background window will also be run and then the sweep housekeeping and input scans will be performed before synchronizing again at the start of the next sweep.

Switching Control to Backup Unit

The amount of time required for a switch in control from the active unit to the backup unit is dependent on the nature of the switch. A switch from the active unit to the backup unit will occur if:

1. the active unit has a failure;
2. the pushbutton switch on the RCM is depressed;
3. commanded by activating a Service Request (SVCREQ #26).

If the switch occurs due to a failure of the PLC CPU (including loss of power), then the switch will occur after the backup unit determines that the active unit has failed to rendezvous at the synchronization point. Failure to rendezvous may take up to 2 failwait timeouts (one for each link) to determine. Control will not transfer, in this case, until both links have been tried unsuccessfully.

If the switch occurs due to a controlled condition such as toggling the RCM unit selection switch, forcing a switch in the user logic program, or because of a fault detected by the PLC CPU, then the switch-over will occur at the beginning of the subsequent sweep. The delay will be up to 1 sweep with the possibility of an input and an output scan after failure detection.

Role Switch SVCREQ

The role switch SVCREQ (SVCREQ #26) will cause the units to switch roles (active to backup *and* backup to active) on the next sweep if the units are synchronized and the timing requirements of the role switch request are met. That is, a manual role switch may not occur within 10 seconds of a previous manual role switch. Role switches due to failures or resynchronization are always allowed (the 10 second limitation does not apply). Power flow from SVCREQ #26 indicates that a role switch will be attempted on the next sweep. Note that power flow *does not* indicate that a role switch has occurred or even that a role switch will occur on the next sweep. For example, the units could fall out of synchronization due to a link timeout before the next sweep which would prevent the role switch from occurring.

An example of the SVCREQ #26 function block is shown below. SVCREQ #26 function has three input parameters and one output parameter. When SVCREQ #26 receives power flow to its enable input, the PLC is requested to perform a role switch. The three input parameters are the *enable* input, the service number *FNC*, and *PARM*, which is the beginning reference for the function parameters. An output coil will be set ON if the operation succeeds.

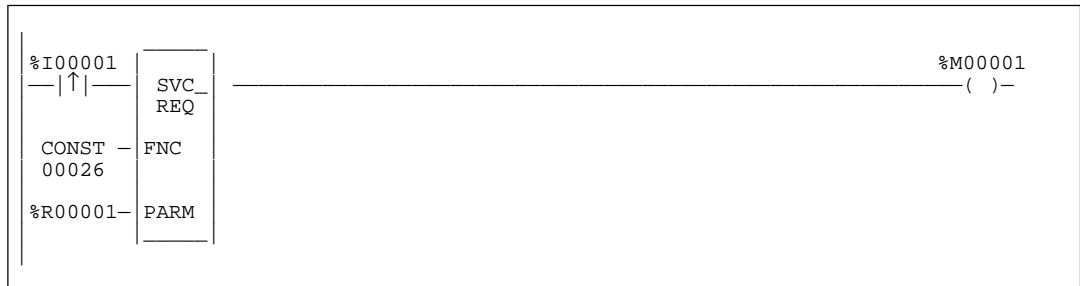

A typical application can be to have a switch on a control console wired to %I0001, which is the input to the SVCREQ #26 function block. When closed, the switch will activate the SVCREQ #26, causing a role switch between units.

Note that the 10 second limitation allows these SVC_REQs to be in both units so that only a single switch occurs if the input is seen by both units.

%S References for CPU Redundancy

There are seven special %S references which reflect the status of the Redundancy units: %S33 through %S39. The definition of these LEDs is shown in the following table.

Table 7. Definition for % S Reference for Redundancy Status

%SBit	Definition	Nickname	Description	LED
%S33	Primary Unit	PRI_UNT	Bit will be set if the local unit is configured as the primary unit; otherwise; it is cleared. For any given local unit, if PRI_UNT is set, then SEC_UNT cannot be set.	no
%S34	Secondary Unit	SEC_UNT	Bit will be set if the local unit is configured as the secondary unit; otherwise; it is cleared. For any given local unit, if SEC_UNT is set, then PRI_UNT cannot be set.	no
%S35	Local Unit Ready	LOC_RDY	Bit will be set if local unit is ready to become the active unit; otherwise it is cleared.	yes
%S36	Local Unit Active	LOC_ACT	Bit will be set if local unit is currently the active unit; otherwise it is cleared. For any given local unit, if LOC_ACT is set, then REM_ACT cannot be set.	yes
%S37	Remote Unit Ready	REM_RDY	Bit will be set if remote unit is ready to become the active unit; otherwise it is cleared.	yes
%S38	Remote Unit Active	REM_ACT	Bit will be set if remote unit is currently the active unit; otherwise it is cleared. For any given local unit, if REM_ACT is set, then LOC_ACT cannot be set.	yes
%S39	Logic Equal	LOGIC=	Bit will be set if the logic program for both units in the redundant system is the same; otherwise the bit is cleared.	no
%SB18	Redundant Informational Message, Fault Logged	RDN_MSG	Bit will be set if a redundant informational message was logged. It can be cleared in reference tables or logic (you may want to do this if logic will be monitoring the bit).	no

These bits can be accessed from the user's logic program, but cannot be altered or overridden. These references are always OFF when no configuration has been stored. Once you have completed configuration of the Redundancy system and STORED the configuration, the state of these %S references is set and is maintained whether in STOP or RUN mode. Four of these references %S35, %S36, %S37, and %S38 are displayed on LEDs on the Redundancy Communications Module, as long as that module is not faulted.

If desired, external indicators other than those on the RCM could be used as status indicators to monitor the status of %S35 through %S38 (Local Ready/Active, Remote Ready/Active) by programming in ladder logic. These four bits in %S memory can be copied to other points from the ladder logic. An example of the expected status of these %S references for each unit (Primary and Secondary) in a Redundancy system is as follows:

Description	Primary Unit	Secondary Unit
Primary Unit	ON	OFF
Secondary Unit	OFF	ON
LocalReady	ON	ON
LocalActive	ON	OFF
RemoteReady	ON	ON
RemoteActive	OFF	ON
LogicEqual	ON	ON

Redundancy CPU Considerations

The Redundancy CPU (CPU 780) has several restrictions and differences in operation as compared to other Series 90-70 CPUs. The following features are not available with the CPU 780:

- *I/O Interrupts*
- *Timed Interrupts*
- *VME Integrator Racks.*
- *Stop I/O Scan mode*
- *Flash operation*

Features not Available with CPU 780

I/O Interrupts

I/O Interrupts are not supported by the Redundancy CPU (CPU 780). This includes the single edge triggered interrupts from the discrete input modules, the high alarm and low alarm interrupts from the analog input modules, and interrupts from foreign VME modules, all of which can be used to trigger a ladder diagram program block. In order to prevent I/O interrupts from changing the data being transferred from one CPU to another, interrupts would have to be disabled for the entire transfer time. Programs which declare I/O Interrupt triggers cannot be stored to the CPU 780 (the program will be rejected causing an abort of the store). In addition, any configuration containing an enabled I/O interrupt for a discrete or analog input module will cause a fatal system configuration mismatch fault.

Timed Interrupts

Timed Interrupts are not supported by the Redundancy CPU (CPU 780). Timed Interrupts would have the same interrupt latency problem as the I/O Interrupts. Programs which declare Timed Interrupt triggers cannot be stored.

VME Integrator Racks

The VME Integrator Racks (IC697CHS782 and IC697CHS783) that support half size modules are not supported with this release of the Hot Standby CPU Redundancy product.

STOP/IOSCAN Mode

The STOP/IOSCAN mode is not valid in a redundant system. If an attempt is made to place the PLC in this mode, the PLC will reject the selection and return an error. A message will be displayed on the programmer with this information.

Flash Operation

Flash memory operation is not supported in this release of the CPU 780.

Differences in Operation for CPU 780

The following features operate differently with the CPU 780 than they do with other Series 90-70 CPUs:

- RUN/DISABLEDmode
- Configuration of Fault Actions
- STOP to RUN mode transition
- Background Window Time (default is different)

RUN Disabled Mode

RUN/DISABLEDmode causes all physical outputs to go to their default state in that PLC. Inputs are still scanned and logic is solved. A CPU in RUN/DISABLED mode *may* be the active unit.

There are several guidelines that you should be aware of regarding the use of the RUN/DISABLEDmode.

1. If a unit is in RUN/DISABLED mode, its LOC_RDY %S reference and the remote unit's REM_RDY %S reference will not be set and the corresponding LEDs on the RCMs will not be ON. This indicates that the unit (with LOC_RDY reference off) is not available to drive outputs.
2. You cannot command a role switch from an active unit that is in RUN/ENABLED mode to a unit that is in RUN/DISABLED mode. The RCM role switch pushbuttons and SVCREQ #26 will be ignored if a role switch is attempted in this situation.
3. If the units are transitioned when the primary unit is active with outputs disabled and the secondary unit is backup with outputs enabled, the primary unit will continue to solve logic and transfer outputs to the backup, and the backup unit will drive the transferred outputs.
4. If units are transitioned in any manner where the secondary unit is active with outputs disabled and the primary unit is backup with outputs enabled, then the units will automatically role switch so that the primary unit becomes active in RUN/ENABLEDmode.
5. If a unit is in RUN/ENABLED and the other unit is in RUN/DISABLED, the unit in RUN/ENABLED will not use its synchronized fault action table. Instead, it will use the user-configurable fault actions since there is no backup available to drive outputs.

Note

If the backup unit is in RUN/DISABLED mode, then the backup unit will continue to NOT drive outputs upon failure of the active unit and *therefore is not a true backup.*

Following are several examples that illustrate the above guidelines. Each example gives the role of each unit, its current operating mode, and the state of the LEDs on the RCMs. An X indicates that the corresponding LED and %S bit is ON.

A. Role switches allowed on both units.

<i>Primary Unit</i>	<i>Secondary Unit</i>
Active	Backup
RUN/ENABLED	RUN/ENABLED
X OK	X OK
X LOC_RDY	X LOC_RDY
X LOC_ACT	LOC_ACT
X REM_RDY	X REM_RDY
REM_ACT	X REM_ACT

B. Role switches allowed on both units.

<i>Primary Unit</i>	<i>Secondary Unit</i>
Active	Backup
RUN/DISABLED	RUN/ENABLED
X OK	X OK
LOC_RDY	X LOC_RDY
X LOC_ACT	LOC_ACT
X REM_RDY	REM_RDY
REM_ACT	X REM_ACT

Note that the Secondary unit drives the outputs in this case.

C. Role switches are **not allowed** on either unit.

<i>Primary Unit</i>	<i>Secondary Unit</i>
Active	Backup
RUN/ENABLED	RUN/DISABLED
X OK	X OK
X LOC_RDY	LOC_RDY
X LOC_ACT	LOC_ACT
REM_RDY	X REM_RDY
REM_ACT	X REM_ACT

D. Role switches are allowed on both units.

<i>Primary Unit</i>	<i>Secondary Unit</i>
Active	Backup
RUN/DISABLED	RUN/DISABLED
X OK	X OK
LOC_RDY	LOC_RDY
X LOC_ACT	LOC_ACT
REM_RDY	REM_RDY
REM_ACT	X REM_ACT

E. Role switches are allowed on both units.

<i>Primary Unit</i>	<i>Secondary Unit</i>
Backup	Active (see NOTE below)
RUN/ENABLED	RUN/ENABLED
X OK	X OK
X LOC_RDY	X LOC_RDY
LOC_ACT	X LOC_ACT
X REM_RDY	X REM_RDY
X REM_ACT	REM_ACT

F. Role switches are **not allowed** on either unit.

<i>Primary Unit</i>	<i>Secondary Unit</i>
Backup	Active (see NOTE below)
RUN/DISABLED	RUN/ENABLED
X OK	X OK
LOC_RDY	X LOC_RDY
LOC_ACT	X LOC_ACT
X REM_RDY	REM_RDY
X REM_ACT	REM_ACT

G. Role switches allowed on both units.

<i>Primary Unit</i>	<i>Secondary Unit</i>
Backup	Active (see NOTE below)
RUN/DISABLED	RUN/DISABLED
X OK	X OK
LOC_RDY	LOC_RDY
LOC_ACT	X LOC_ACT
REM_RDY	REM_RDY
X REM_ACT	REM_ACT

H. The following situation is not valid. If detected, the units will switch roles automatically and behave as in (C) above.

<i>Primary Unit</i>	<i>Secondary Unit</i>
Backup	Active (see NOTE below)
RUN/ENABLED	RUN/DISABLED

Note

* Secondary unit *active* is not a recommended mode of operation.

Configuration of Fault Actions

With the Redundancy CPU, you cannot select to configure certain faults to be FATAL (causing the CPU to STOP). Whenever the system is in redundancy mode with a backup unit available, the decision as to which faults are FATAL and therefore will cause a switch to the backup CPU are made by the operating system and are not configurable.

Specific fault actions are described in Section 2 of this Chapter. However, you can configure whether or not a stand-alone CPU (after failure of the other CPU) will stop if another fault occurs.

You can select the fault actions (either diagnostic or fatal) for when a given CPU is operating without a backup available. This will allow you to choose between fault tolerant operation and a safety system where a shutdown is preferred.

If you do choose to set these fault actions to be diagnostic when the system is running, but not synchronized, the unit may remain the active unit even after the backup unit has been placed in RUN mode. Also, a unit with the fault actions set to diagnostic may be placed in RUN mode and become the active unit even though it may have a diagnostic fault which would be logged as fatal in a synchronized system.

For example, if you were to configure "Loss of or Missing Rack" failures as diagnostic, then the following conditions would apply:

- If an expansion rack fails when the units are synchronized, the unit with the rack failure will transition to STOP/FAULT mode and the other unit will become a stand-alone unit.
- If an expansion rack fails after a unit becomes a stand-alone unit, a diagnostic fault will be logged on that unit but the unit will stay in RUN mode and continue to control the process.
- If after the above situation occurs, the other unit transitions to RUN, the unit with the failed expansion rack will stay in RUN mode and may, depending on the configuration, remain in control of the process. With this situation, you may want to include logic to shut down the faulted unit if this is an undesired operation.
- If an expansion rack fails while in STOP mode or while transitioning to RUN mode, a diagnostic fault is logged; however, the unit will still transition to RUN and may, depending on configuration, become the active unit. You may want to include logic to shut down the faulted unit if this is an undesired operation.

STOP to RUN Mode Transition

A resynchronization will occur at all *STOP* to *RUN* mode transitions. The time to perform this resynchronization may be very large and will exceed the current transition. The *STOP* to *RUN* mode transition has two separate paths.

1. If the CPU performing the transition is doing so alone or both CPUs are transitioning at the same time, then a normal *STOP* to *RUN* mode transition is performed (clear non-retentive memory and initialize FST_SCN and FST_EXE).
2. If the other CPU is active when this CPU performs a *STOP* to *RUN* mode transition, then non-retentive references will be cleared followed by a resynchronization with the active CPU.

Background Window Time

In a redundancy system, this value may be set to zero. Unlike other CPU models which have a default of 0 ms, the default value for the CPU 780 is 5 ms.

Background User Checksum and Background Window Timing Instructions

The following information is provided to allow you to guarantee full coverage of the number of program words verified by the User Program Checksum per sweep and the Background Window Diagnostics within a certain amount of time. It is important to understand that the more checksums performed and the larger the background window, the longer the sweep will take. For example setting the number of words to checksum to 176 will add 2.8 ms to each sweep.

First, you should determine the number of words to checksum per sweep.

$$\text{Words per Sweep} = \frac{(\text{program size} + 2) \times (\text{sweep time}) \times \text{maximum completion time}}{[\text{max. completion time} - (\text{program size} \times F)] \times \text{max. completion time} - C - (C \times F \times \text{program size})}$$

Where:

- *Words per Sweep*: The number of words to set in the PLC Configuration to be checksummed each sweep. This number must be a multiple of 8.
- *Program Size*: The size of the user program in bytes. You can get this from the Logicmaster 90 PLC Memory Usage screen, which is accessed by pressing the **status** softkey (F3) from the Programmer Main menu, then the **plcmem** softkey (F5). Add the "USER PROGRAM" size on this screen to 10566 (this accounts for internal memory usage not added to the user program memory).
- *Sweep Time*: The sweep time in milliseconds of the user program with checksums and background window turned off. You can get this from the Logicmaster 90 status line on any screen.
- *Maximum Completion Time*: The amount of time in milliseconds that you want to have full coverage of background diagnostics.
- *F*: A constant that represents milliseconds per byte of user program checksummed. This constant is dependent on the type of CPU module (that is CPUs with 80386 microprocessors are faster than CPUs with 80186 microprocessors). This constant is 0.008 ms/byte for the CPU 780.
- *C*: A constant with units in milliseconds, which is also dependent on the type of CPU. For the CPU 780 it is 4480 ms.

Following is an example of calculating the Words per Sweep, using the following data:

User program Size = 89434 bytes
 Program Size = User program Size + 10566 = 89434 + 10566 = 100000 bytes
 Sweep Time = 100 ms
 Max. Completion Time = 120000 ms (2 minutes)

$$\text{Words per Sweep} = \frac{100000 \div 2 \times 100 \times 120000}{[120000 - 100000 \times 0.008] \times (120000 - 4480) - (4480 \times 0.008 \times 100000)}$$

Words per Sweep = 174

You should round this answer (174) up to the nearest number divisible by 8 (8, 16, 24, etc.) which is 176 since Logicmaster 90 only accepts numbers divisible by 8. Next use this number in the following formula to determine how long to set the background window time.

$$\text{Background Window Time} = \frac{C \times (\text{sweep time} + \text{words per sweep} \times F \times 2)}{(\text{maximum completion time} - C)}$$

Where the Background Window Time is the time in milliseconds that you should set the background window timer. The other elements in the formula are described above in the calculation for words per sweep. The constants (F and C) are for the CPU 780.

$$\text{Background Window Time} = \frac{4480 \times (100 + 176 \times 0.0008 \times 2)}{(120000 - 4480)}$$

Background Window Time = 3.9 rounded up to 4 ms

Miscellaneous Operation Information

Timer and PID Function Blocks

These function blocks will remain in lock step between the two synchronized units provided:

- A. Enabling logic is identical on both units. This includes power flow, frequency of calling sub-block, etc..
- B. The sub-block in which the function block occurs has the same name in both units. Note that __MAIN is always common.
- C. Reference registers (3 for timers, 40 for PID) and reset references are copied from the unit that was in stand-alone to the unit that just transitioned to RUN for each timer and PID function block. This copy does not need to be performed if both units transition to RUN in the same sweep.

For example, if the following ladder logic is identical in sub-blocks on both units, then %M100, %R250, %R251, and %R252 must all be transferred on resynchronization to keep both units running timers synchronously:

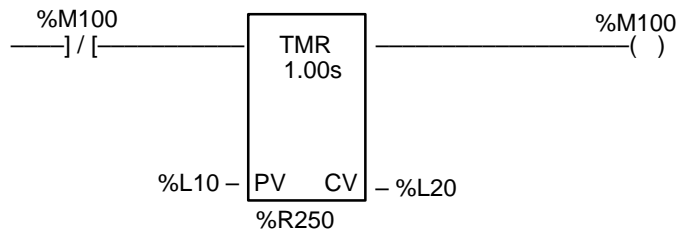

Timed Contacts

When both systems are synchronized, timed contacts will have exactly the same value in both units. That is, whenever T_SEC is on in one unit, it will also be on in the other unit as long as both units are synchronized.

OVR_PRE %S Reference

The OVR_PRE %S reference which indicates whether one or more overrides is active is *not* supported by the CPU 780. This reference should not be used in a redundancy system.

Genius Bus Controller Switching

Genius Bus Controllers will stop sending outputs to blocks when no data has been received from the PLC CPU for a period equal to two times the configured watchdog timeout.

If the CPU on the active unit becomes inoperative in an uncontrolled fashion (for example, because of a power failure), the Genius Bus Controllers will detect this within twice the watchdog setting, and stop sending outputs to the Genius blocks. After three Genius I/O bus scans of not receiving data from the Genius Bus Controllers, the Genius blocks will start driving data from Serial bus Address 30 (that is, the backup unit). If no data is available from SBA 30, the blocks revert to default or hold last state (as configured).

For example, if the system has a 200 ms watchdog timeout and 5 ms Genius bus scan time, then if the active unit loses power, the Genius Bus Controllers on expansion racks will wait 400 ms and then stop updating outputs on Genius blocks. 15 ms later, the blocks will begin driving outputs based on data from the backup unit. Note that any Genius Bus Controllers in the main rack would stop driving outputs immediately since they would also lose power. Genius blocks on these busses would begin driving data from the backup unit within 15 ms.

Note

For fastest switching, all Genius Bus Controllers in the Hot Standby CPU Redundancy system should be in the main rack, or in a rack driven by the main rack's power supply. This will cause the Genius Bus Controller to lose power at the same time that the CPU loses power and allow the backup unit to gain full control of the I/O as soon as possible.

Section 6: Fault Detection and Control Actions

This section describes how faults are handled in a Redundancy system. It discusses how faults affect the operation of the Redundancy system, describes categories of faults, describes how faults are detected, describes the actions taken when faults are detected, and discusses on-line repair of individual components.

Fault Detection

The Hot Standby CPU Redundancy system requires that faults or failures in all critical components be detected and reported so that appropriate control actions may be taken. All components that are involved in the acquisition and distribution of I/O data or are involved in the execution of the control logic solution are considered to be critical components.

In a Redundancy system, fault actions are not configurable as they are in a non-redundancy (Simplex) system. A FATAL fault will cause a switch from the active to the backup unit; a DIAGNOSTIC fault will allow the currently active system to continue operating as the active system.

Faults within the PLC may be such that (1) the PLC has a controlled shutdown, (2) the PLC has an uncontrolled shutdown, or (3) the PLC continues to operate. If the PLC has detected an internal fault and has a controlled shutdown, a fault will be logged in the fault table, the backup system will be notified of the fault and the PLC will go to stop mode and stop driving outputs. This does not normally occur until the top of the sweep following the failure. The exception is when the failure occurs during the input scan. Upon notification, the backup system will immediately take over and start driving outputs.

If the PLC has an uncontrolled shutdown the PLC will log a fault if it can and proceed as described above. If the backup PLC detects that the active PLC has failed to synchronize, it will assume the active unit has failed after timing out all (both) available links. The backup will then start driving outputs and controlling the process. If a fault exists within the PLC, but has not been detected, the system will eventually detect the fault through the background diagnostic procedure. When the fault is detected, the PLC will proceed with the orderly shutdown process if it can.

If the two PLCs fail to synchronize, because the timeout is set too short, then the two systems will begin to act independently. A fault will be logged at the time synchronization failure occurs.

Fault Categories

The detection of faults and failures falls into three basic categories:

1. faults and failures that are detected immediately;
2. faults and failures that are detected as soon as possible, but not necessarily within the current sweep;

3. faults and failures that are detected in the background.

Faults and failures that are detected immediately are those that are identified within the current sweep. These faults include I/O data corruption, single bit RAM failures, power supply failures, processor failures, VME bus failures, and no response from an addressed module.

Faults and failures that are detected as soon as possible, but not necessarily within the current sweep, include a group of faults that are detected asynchronously to the PLC sweep (Genius faults) or those faults that require a timeout larger than one sweep time to detect the failure. These faults are typically detected within one second and include all Genius faults (circuit faults, loss of block, etc.)

Faults and failures that are detected in the background can be detected within 30 seconds. These faults include address or data line failures, multiple bit RAM failures, EPROM failures, and communication device failures.

Changing Fault Category Actions

Fault category actions can be changed for both non-redundant systems and redundant systems that are *not* synchronized. When the redundant system is synchronized, the fault category actions *cannot be changed*.

PLC Fault Table

The following table lists fault zoom Help text and messages for error codes associated with the redundancy fault group.

Table 8. Fault Zoom Help Text for Redundancy Error Codes

Error Code	Message	Fault Description	Corrective Action
1	Primary Unit is Active and Secondary Unit is Backup.	The primary and secondary units have switched roles.	None required.
2	Secondary Unit is Active and Primary Unit is Backup.	The secondary and primary units have switched roles.	None required.
3	Primary Unit is Active; No Backup Unit Available.	The primary unit has transitioned to RUN mode and is running as a stand-alone unit.	Secondary unit MUST be placed in RUN mode with a comparable configuration in order to have a synchronized system.
4	Secondary Unit is Active; No Backup Unit Available.	The secondary unit has transitioned to RUN mode and is running as a stand-alone unit.	Primary unit MUST be placed in RUN mode with a comparable configuration in order to have a synchronized system.
5	Primary Unit Has Failed; Secondary Unit is Active w/o Backup.	Primary unit has recorded a fatal fault, has been powered down, or has lost ability to communicate with the secondary unit while acting as the active or backup unit. Secondary unit will continue running as a stand-alone unit.	If primary unit has also logged the fault "Secondary Unit Has Failed: Primary Unit is Active w/o Backup", then communications has been broken between the two units and must be repaired. If a fatal fault has been logged in the primary unit, the indicated fault must be repaired. Power may have to be cycled on one of the units in order to re-establish communications and return to a synchronized system.
6	Secondary Unit Has Failed; Primary Unit is Active w/o Backup.	Secondary unit has recorded a fatal fault, has been powered down, or has lost ability to communicate with the primary unit while acting as the active or backup unit. The primary unit will continue running as a stand-alone unit.	If secondary unit has also logged the fault "Primary Unit Has Failed: Secondary Unit is Active w/o Backup", then communications has been broken between the two units and must be repaired. If a fatal fault has been logged in the secondary unit, the indicated fault must be repaired. Power may have to be cycled on one of the units in order to re-establish communications and return to a synchronized system.
7	Synchronization Failure; Both Units are Active.	A communications failure between the two units has caused each unit to become stand-alone units. Communications has since been restored.	One of the units should be power cycled to return to a synchronized system. NOTE: The Genius blocks will respond to the unit that is using Serial Bus Address 31.
8	Unable to Switch Redundancy Roles	An attempt to switch redundancy roles was made when it was not possible to perform the switch.	None required.
9	Primary and Secondary Units are Incompatible	The local unit cannot be placed in RUN mode when its redundancy configuration is incompatible with the remote unit. This error is logged when (1) Store of an incompatible config is attempted and (2) going to RUN with an incompatible config.	Modify the configuration.
10	CPU to CPU communications terminated	Synchronization protocol has been violated.	If this fault is also accompanied by an RCM failed fault, replace the failed RCM; otherwise power cycle the CPU or CPUs.
11	Redundant Link has timed out	The RCM has timed out while waiting on communications from the other unit.	Power cycle the back-up CPU (CPU not controlling the process); increase the fail wait time.
>11	CPU Redundancy Status has Changed	A change in the status of the system has occurred. Press Ctrl-F to determine the error code.	Corrective action to be taken depends on the error code.
57	Redundant link hard failure occurred.	The RCM has been faulted due to an error while accessing memory.	Power cycle the rack with the faulted RCM. If the RCM's BOARD OK LED is on, replace the cable between the RCM and the BTM. If the RCM's BOARD OK LED is off, replace the RCM.

Faulting RCMs, Losing Links, and Terminating Communications

There are distinct differences between losing a redundant communications link, faulting an RCM, and terminating communications.

Faulting the RCM module occurs only when a hardware related failure occurs such as a parity error or VME bus error.

Action taken when a board is faulted:

- Module Failed fault is logged in the PLC Fault Table.
- All LEDs on the RCM module are turned OFF. The LEDs on the other RCM will continue to be updated as long as that RCM is OK.
- The module fault contact is set.
- The corresponding communications link is no longer used. If the other link is still operating, then that link will be used for all further data transfer and units can remain in synchronization.
- If no other communications link is available, then the unit functions as a stand-alone unit when in RUN mode.
- A power cycle, after replacement of the faulted RCM, is required to restore the RCM to service.

Losing a Link occurs when a link timeout occurs (that is, no data received in the expected time period). Since the system is not certain that a lost link is due to a hardware failure, the RCM is not faulted. Some possible causes for a link timeout are:

1. Remote unit has failed and is unable to communicate.
2. Configured fail-wait timeout is too short and a long sweep or communications window has resulted in a link timeout. Normally the other link will continue to function in this case and the systems remain synchronized. If the condition continues, the remaining communications link will timeout in a subsequent sweep.
3. A hardware problem is present that prevents data from being transferred but is not detectable by error checking mechanisms such as parity errors (there are no known problems in this category).

Action taken when a link has timed out.

- Link Timeout fault is logged in the PLC Fault Table.
- The OK and Local LEDs on the RCM in the RCM to BTM link that failed will continue to be maintained (that is, they will stay ON and the Local LEDs will reflect the state of the Local unit) but the Remote LEDs will be turned OFF. The LEDs on the other RCM will continue to be updated as long as that RCM is OK.
- The module fault contact is set.
- The corresponding communications link is no longer used. If the other link is still operating, then that link will be used for all further data transfer and units can remain in synchronization.
- If no other communications link is available, then the unit functions as a stand-alone unit when in RUN mode.
- A power cycle of either unit is required to restore the link to service.

- In this case, if the RCM is at fault, it will need to be replaced before power is restored.

Terminating Communications occurs when the two units get out of synchronization.

The action taken when communications is terminated is the same as when a link has timed out, except that actions are taken on both links and the Communications Terminated fault is logged rather than Link Timeout.

Fault Actions in a CPU Redundancy System

Fault actions in the Hot Standby CPU Redundancy System are handled differently than those in a non-redundancy (Simplex) system. Whenever there is a "ready" backup unit configured in the system, the fault actions in the active unit will not be those normally specified by the user. For an active unit with a ready backup, any fault which will cause a degradation in performance, or loss of control of I/O which does not cause a similar degradation of performance or loss of control of I/O in the backup will be considered a FATAL fault in the active unit and cause the active unit to transition to *STOP* mode.

The configurable fault actions will be applied whenever the system is running in stand-alone mode in case you prefer fault tolerance (availability) versus safety (depending on the application). The following tables (1) define the Fault Groups and (2) show the fault groups and their fault action defaults. There are three fault actions shown in Table 11: *Fatal*, *Non-Fatal*, and *Conditionally Fatal*. Fatal always stops the PLC, Non-Fatal never stops the PLC and Conditionally Fatal stops the PLC depending on other information in the fault.

Table 9. Maskable Fault Group Descriptions

Fault Group	Table Type	Description
LOSS_RACK	CPU	Loss of or Missing Rack
LOSS_IOC	I/O	Loss of or Missing IOC
LOSS_IO_MOD	I/O	Loss of or Missing I/O Module
LOSS_OTHR_MOD	CPU	Loss of or Missing Option Module
ADD_RCK	CPU	Addition of or Extra Rack
ADD_IOC	I/O	Addition of or Extra IOC
ADD_IO_MOD	I/O	Addition of or Extra I/O Module
ADD_OTHR_MOD	CPU	Addition of, Reset of, or Extra Option Module
IOC_FAULT	I/O	IOC or I/O Bus Fault
IO_MOD_FAULT	I/O	I/O Module Fault
CNFG_MIS_MTCH	Both	System Configuration Mismatch
SYS_BUS_ERROR	CPU	System Bus Error
CPU_HARDWR	CPU	CPU Hardware Failure
MOD_HARDWR	CPU	Module Hardware Failure (e.g. Serial Port Failure on PCM)
IOC_SOFTWR	I/O	IOC Software Failure
MOD_OTHR_SOFTWR	CPU	Option Module Software Failure
PRG_BLK_CHKSUM	CPU	Program Block Checksum Mismatch
LOW_BATTERY	CPU	Low Battery in the System
CNST_SW_EXCD	CPU	Constant Sweep Exceeded
PLC_FTBL_FULL	CPU	PLC System Fault Table Full
IO_FTBL_FULL	CPU	I/O Fault Table Full
APPLICATION_FLT	CPU	User Application Fault

Table 10. Maskable Fault Group Actions

Fault Group	Fault Action		User Configurable
	<i>SimplexMode</i>	<i>RedundantMode</i>	
LOSS_RACK	Non-Fatal	Fatal	Yes
LOSS_IOC	Non-Fatal	Fatal	Yes
LOSS_IO_MOD	Non-Fatal	Non-Fatal	Yes
LOSS_OTHR_MOD	Non-Fatal	Non-Fatal	Yes
ADD_RCK	Non-Fatal	Non-Fatal	No
ADD_IOC	Non-Fatal	Non-Fatal	No
ADD_IO_MOD	Non-Fatal	Non-Fatal	No
ADD_OTHR_MOD	Non-Fatal	Non-Fatal	No
IOC_FAULT	Non-Fatal	ConditionallyFatal	Yes
IO_MOD_FAULT	Non-Fatal	Non-Fatal	No
CNFG_MIS_MTCH	Fatal	Fatal	Yes
SYS_BUS_ERROR	Fatal	Fatal	No
CPU_HARDWR	Fatal	Fatal	No
MOD_HARDWR	Non-Fatal	Non-Fatal	No
IOC_SOFTWR	Fatal	Conditionallyfatal	No
MOD_OTHR_SOFTWR	Non-Fatal	Non-Fatal	No
PRG_BLK_CHKSUM	Fatal	Fatal	No
LOW_BATTERY	Non-Fatal	Non-Fatal	No
CNST_SW_EXCD	Non-Fatal	Non-Fatal	No
PLC_FTBL_FULL	Non-Fatal	Non-Fatal	No
IO_FTBL_FULL	Non-Fatal	Non-Fatal	No
APPLICATION_FLT	Non-Fatal	Non-Fatal	No

The two fault groups IOC_FAULT and IOC_SOFTWR faults are Conditionally Fatal to the system (forces the PLC to *STOP FAULT* mode) whenever the fault that is logged is *Fatal* to the Genius Bus Controller that logged the fault. When a module logs a fault it notifies the PLC whether or not it can continue by placing *Fatal* or *Diagnostic* in the fault action of the fault entry. The PLC will shut the Genius Bus Controller down on all *Fatal* faults.

Note

In a CPU redundancy system a *Fatal* fault from a GBC will cause the active unit to transition to *STOP FAULT* mode. All *Diagnostic* faults will allow the CPU to continue to operate.

Table 11. Non-Maskable Fault Group Descriptions

Fault Group	Table Type	Description
SYS_BUS_FAIL	CPU	Systembus failure.
NO_USER_PRG	CPU	No User's Program on Power-up.
BAD_USER_RAM	CPU	Corrupted User RAM detected on Power-up.
WIND_CMPL_FAIL	CPU	Window Completion Failure in Constant Sweep Mode (i.e., all windows failed to receive their allotted time).
PASSWD_FAIL	CPU	Password Access Failure.
NULL_SYS_CNFG	CPU	NULL System Configuration for RUN Mode.
CPU_SOFTWR	CPU	PLC CPU Software Failure.
TOO_MANY_IOCS	CPU	More than the allowable number of I/O Bus Controllers were found in the system.
SEQ_STORE_FAIL	CPU	<i>Communication</i> failure during a store operation by the programmer. This fault results when the start-of-store sequence was received but not an end-of-store sequence.

Table 12. Non-Maskable Fault Action Descriptions

Fault Group	Fault Actions	
	<i>Simplex Mode</i>	<i>Redundant Mode</i>
SYS_BUS_FAIL	Fatal	Fatal
NO_USER_PRG	Non-Fatal	Non-Fatal
BAD_USER_RAM	Fatal	Fatal
WIND_CMPL_FAIL	Non-Fatal	Non-Fatal
PASSWD_FAIL	Non-Fatal	Non-Fatal
NULL_SYS_CNFG	Non-Fatal	Non-Fatal
CPU_SOFTWR	Fatal	Fatal
TOO_MANY_IOCS	Fatal	Fatal
SEQ_STORE_FAIL	Fatal fatal	

On-Line Repair

With a Hot Standby CPU Redundancy system most system component failures can be repaired by replacing the failed component while the system is on-line. These on-line repair procedures are possible because of the role switching capability of the units in the system. Status of the Primary and Secondary units is determined by observing the LEDs on the Redundancy Communications Module. There are two basic situations regarding the active and backup units that you should be aware of when a component needs to be replaced.

1. *If the failure is in the active system*, control will switch to the backup system. Power can then be removed from the rack containing the failed component. When the component is replaced and power is restored to the rack, the CPU will become synchronized with the current active unit and, if Primary will take control.
2. *If the failure is in the backup system*, remove power from the rack containing the failed component and replace the component. When power is restored to the backup unit it will become synchronized with the active unit and, if Primary will take control.

The following paragraphs describe how the system can be repaired without interruption of control. The replacement of each replaceable component is described.

Note

If maintenance is to be performed on a unit when that unit is the active unit in a synchronized system, then control should be switched to the other unit before powering down. This will allow for an orderly transfer of control.

After repairing a defective unit:

1. Power-up the CPU rack in STOP mode.
2. Verify that the Remote Ready and Remote Active LEDs are on while in STOP mode.
3. Verify that the Local Ready and Local Active LEDs are on in the Active unit.
4. Put the repaired unit in RUN mode.

Maintaining Parallel Bus Termination

It is important when doing on-line repair to maintain parallel bus termination on the active unit. This is the reason that the terminated parallel cable (IC697CBL811 or IC697CBL826) is used, and why the RCM *must* be the last device on the parallel bus. The terminated end of the cable may be safely removed from a de-energized RCM. These terminated cables should be considered an integral part of the unit it terminates.

On-Line Repair Recommendations

It is advised when doing on-line repair to power-off the entire PLC system (of the suspect unit), including ALL RACKS. Change the suspect part, and power-up in STOP mode. Verify that the links are operational before switching to RUN (%S bits and RCM LEDs update in STOP mode).

Power Supply

The power supply has adequate internal fault detection which will cause it to automatically shut down if there is a failure. In an orderly shut down, the power supply will first assert the ACFAIL signal before it asserts the SYSREST signal. This will give the active PLC time to notify the backup PLC that it can no longer control the process.

A power supply failure will be indicated by the absence of the OK indication at the power supply. There are a small number of failures that can result in a false indication or no indication. The probability of these occurring are extremely low compared to the major failure items of the power supply.

In the event of a power supply failure, the backup CPU takes control of the system. The power supply can be replaced with power removed from its rack without interruption to the application being controlled. When the power supply is replaced, power can be returned to the rack and the CPU will then obtain synchronization with the active system and either take control or become the backup CPU.

Racks

The only detectable rack failure is bad data across the backplane. This bad data can take the form of a bad control line as well as a bad data or address line. In most cases bad data lines will be detected by the data integrity checks associated with the data transfers. If these occur the system will be faulted and control transferred to the backup unit. An indication will be given that a data transfer error has occurred.

There is no single indication that a rack failure has occurred. The rack is a very reliable component in the system and rack failures are extremely rare. A rack failure (other than a catastrophic rack failure) will only be correctly diagnosed by process of elimination.

In the unlikely event that a rack failure does occur and is correctly diagnosed, the rack can be replaced with power removed from the system. When the rack is replaced and power restored to the system, the CPU will then obtain synchronization with the active system and either take control or become the backup CPU.

Central Processor Unit

If the CPU 780 fails, the OK light on the CPU will be out or blinking. In addition, fault information will be available in the Fault Table of one or both CPU's.

In the event of a CPU failure control is transferred to the backup system. CPU replacement can be accomplished by removing power from the rack and replacing the CPU. When power is returned to the system, the program can be loaded into the CPU and the CPU started. It will then obtain synchronization with the active system and either take control or become the backup CPU.

Redundancy Communications Module and Cables

If a fault is detected in a single RCM or in its terminated I/O cable, the backup RCM will be used. Control will not transfer to the backup CPU. An RCM fault will be logged in the PLC Fault Tables of both PLCs. *The loss of an RCM is not fatal.* If there are expansion racks within a system, and the cable fault is such that the system can no longer communicate to the expansion racks, then the fault is fatal and the PLC will be halted. Control will then transfer to the backup PLC.

If an RCM fault is detected, proceed as follows:

- STOP the unit with the suspected bad RCM.
- Turn power off at that rack.
- Unplug the terminated cable from the RCM and replace the module.
- Reconnect the terminated cable.
- Power-up the rack (mode switch is still in STOP).
- Verify that the REMOTE ACTIVE and REMOTE READY LEDs are on, or look at the %S bits in the stopped unit. *Note that the RCM LEDs only update if the board is not faulted.*
- Switch the repaired unit to RUN.

Redundancy Communications Link Failures

There are two types of Redundancy Communications Link failures; a "Link Timeout" and a "Hard Link Failure". When a *Link Timeout* occurs, the RCM BOARD OK LED will remain ON and the LOCALREADY and LOCALACTIVE LEDs will continue to reflect the status of the Local unit. The REMOTE ACTIVE and REMOTE READY LEDs will not be updated by the Remote unit until the link is reinitialized by storing a configuration or power cycling either unit. When a *Hard Link Failure* occurs, all five RCM LEDs will be OFF. A power cycle of the Local unit is required to attempt to reinitialize the failed link.

Bus Transmitter Module

A fault in the BTM is treated just like a fault in the RCM. It is only fatal if the fault prevents communications to any expansion racks within the system.

Failure of the BTM module may not easily be distinguished from an RCM cable failure or even an RCM failure. However, most failure modes of the BTM can be isolated to the BTM. When a BTM fails, the system will respond as described for the RCM and cable failure, it will only fault the active PLC if the active PLC has expansion racks with critical components installed.

The BTM can be replaced by removing power from the rack and replacing the BTM. When power is restored to the CPU, the CPU will obtain synchronization with the active system and either take control or become the backup CPU.

Genius Bus Controller

In a synchronized Hot Standby CPU Redundancy system, all GBC faults are considered fatal. The failure of a Genius bus controller will be detected and isolated by the PLC. If a GBC fails in the active PLC, the active PLC will fail and the backup will assume control.

The GBC can be replaced by removing power from the rack and replacing the GBC. When power is restored to the CPU, the CPU will obtain synchronization with the active system and either take control or become the backup CPU.

Genius Bus

Genius bus faults are not fatal to the PLC. However, if a bus fault exists, it exists for both systems. There may be situations where one controller can communicate to more blocks than the other controller can. Since both controllers are running with the same outputs and shared inputs, and both controllers are still synchronized, the blocks will choose which controller to respond to, if either can be heard.

The Genius bus can be repaired without disturbing power to either system and thus without disturbing which PLC is in control of the process. Replacement of a bus can be done on line but is not recommended because all devices on that bus will be lost until the bus is repaired.

Genius Blocks

The failure of a single block is not fatal to the PLC.

Redundancy Alternatives

There are several redundancy alternatives for the Series 90-70 Programmable Logic Controller. These redundancy options consist of implementation of the redundancy feature through a user logic program *or* through a redundancy product which consists of both hardware and software. The type of redundancy product alternative that is used is also referred to as the *Control Strategy*, which must be defined for configuration purposes. Redundancy alternatives are:

- Hot Standby Application Logic;
- Hot Standby Product plus Application Logic;
- Hot Standby Product (described in this manual);
- ESD (Emergency Shutdown System) Duplex Application Logic;
- ESD Duplex and Triplex GMR (Genius Modular Redundancy) (see *GFK-0787, Genius Modular Redundancy User's Manual*).

For your information the following *Redundancy Selection Guide* is provided which lists the features desired through implementation of a redundancy system followed by a table which further describes these redundancy options.

Note

Note that the redundancy option described in this manual is the *Hot Standby Product*.

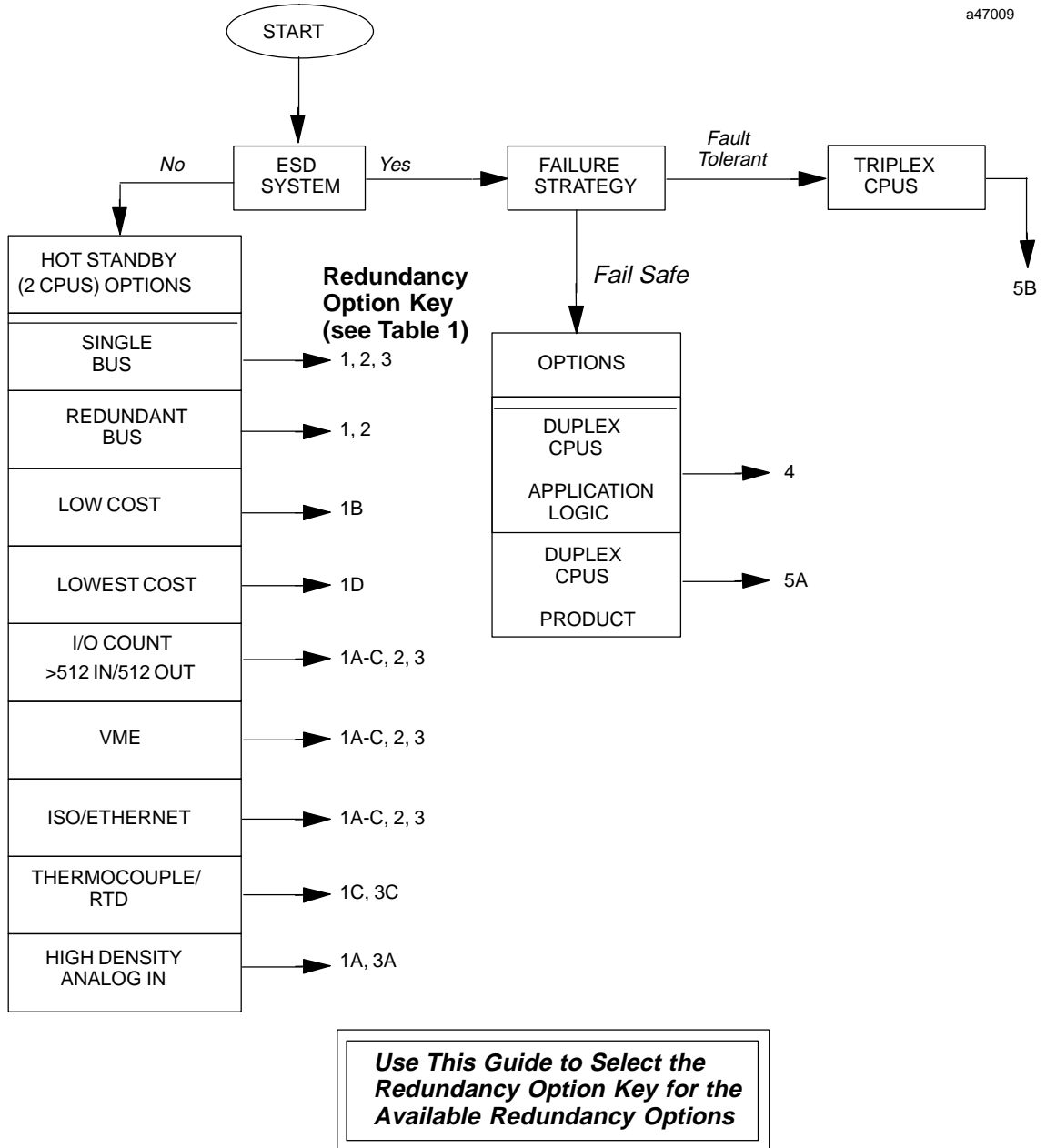

Figure 9. Guide to Selection of Redundancy Option Key for Table 1 (Redundancy Options)

Table 13. Redundancy Options

Option	Key	PLC	Scan Sync	Data Sync	I/O System	Output Selection Method	Redund. Bus	Redund. I/O	Selection Guide
Hot Standby Application	1A	290-70s	no	Application Logic †	90-70 (I/O Scanner)	Hot Standby	yes - 2	no	Higher Density Analog Inputs
	1B	290-70s	no	Application Logic †	90-30 (GCM+)	Hot Standby	yes - 2	no	More competitive I/O
	1C	290-70s	no	Application Logic †	Genius I/O	Hot Standby	yes - 2	no	Highly distributable with diagnostics. Thermocouple. RTD
	1D	290-70s	no	Application Logic †	90-30 (GCM+)	Hot Standby	yes - 2	no	Least expensive. Limited to 512 Inputs, 512 Outputs
Hot Standby Product plus Application Logic	2	290-70s	yes	Operating System Function	90-30 (GCM+)	Hot Standby	yes - 2	no	Redundant Bus Applications. More competitive I/O.
Hot Standby Product	3A	290-70s	yes	Operating System	90-70 (I/O Scanner)	Hot Standby	no	no	Higher Density Analog Inputs
	3B	290-70s	yes	Operating System	90-30 (GCM+)	Hot Standby	no	no	More competitive I/O.
	3C	290-70s	yes	Operating System	Genius I/O	Hot Standby	no	no	Highly Distributable with diagnostics. Thermocouple. RTD.
ESD Duplex Application Logic	4	290-70s	no	no	Genius I/O	Duplex	yes - 2	yes	For Fail-Safe ESD applications.
ESD Duplex GMR Product	5A	290-70s	no	no	Genius I/O	GMR	yes - 2 or 3	yes	For Fail-Safe or fault tolerant ESD applications.
ESD Triplex GMR Product	5B	390-70s	no	no	Genius I/O	GMR	yes - 3	yes	For fault tolerant ESD applications.

† See list of restrictions below.

Explanation of terms used in the above Table of Redundancy Options.

Hot Standby Redundancy	Two CPUs are connected to one or more I/O. One CPU is active; the other is in standby. If the active unit fails, the standby unit takes control of the process (Hot Standby Redundancy is sometimes known as Hot Backup Redundancy).
Scan Synchronization	Scan mechanisms may be synchronized to keep active and standby units in lockstep to minimize "bumps" or upsets to the process when switching from active to standby unit.
Data Synchronization	Keeps standby unit refreshed with the current state of the active unit to minimize "bumps" or upsets to the process when switching from active to standby unit.
Emergency Shutdown System (ESD)	Two or three unsynchronized CPUs solve logic asynchronously based on common inputs. Output state is voted on by the output devices. The inputs and outputs are normally energized and do not change state. DUPLEX ESD is Failsafe while TRIPLEX ESD is fault tolerant.
Application Logic-Based Solutions	Has many restrictions (see the list of restrictions on page 13).
Product Solutions	Has functions built into the operating system that make the system easier to engineer and more robust. Product solutions are preferable to application solutions from a support perspective.
Output Selection Method	Refers to the algorithm in the I/O device, such as Hot Standby, Duplex, or No Redundancy Modes. These modes may refer to existing Genius I/O terminology. GMR (Genius Modular Redundancy) mode is a voting algorithm available in Genius I/O DC blocks.
FailSafe	An ESD system will fail such that the process under supervision will be shutdown.
Fault Tolerant	In an ESD system any single failure will not disrupt the process under supervision.

Series 90-70 Redundancy Through Application Logic

The following restrictions apply using the current Series 90-70 for redundancy applications requiring synchronization (*these restrictions do not apply to the Hot Standby CPU Redundancy product*).

- Do not use transitional contacts or coils since this information cannot be transferred across the link.
- Avoid using timers, counters or PID in program blocks which are not called every sweep otherwise timer durations may not match up when control is transferred.
- Since PID keeps the actual real time clock in its data structure, you cannot simply execute it all the time while updating its entire data structure. You must omit the clock portion of the data structure when you do the transfer. Another safer method would be to keep the backup unit in manual mode while forcing the manual register to the output of the master. When the switch-over occurs, put the PID in auto.
- The time of day clock cannot be shared between PLCs, therefore it cannot be used to make program decisions.
- Do not use MCRs since the internal value of the MCR cannot be transferred between systems.
- Do not expect information that comes in to the system from an external communications device to be the same in both systems. The communications can change data in one system before it is updated in another.
- Avoid using fault contacts and fault table information to base critical program decisions, some of the information is not available to be passed between systems.
- Avoid using the timed contacts since the internal PLC's real time clocks will not match.
- Local program block memory (%L) cannot be transferred between the PLCs, therefore data that must be shared should be restricted to the transferred memories.

A

Acronyms, list of, 12
 Active and backup sweeps, 59
 Active unit, 2, 4, 7, 8, 9, 16, 19, 20, 21, 25, 57, 58, 59, 60, 61, 65, 68, 71, 72, 77, 78, 80
 Appendix A, redundancy alternatives, 85
 ASCII identifier for control strategy, 58

B

Background user checksum, 69
 Background window, 69
 Background window time, 68
 Backup and active sweeps, 59
 Backup data size, 9
 Backup unit, 2, 7, 8, 9, 19, 20, 21, 25, 55, 57, 59, 60, 61, 65, 67, 68, 71, 72, 77, 80, 81
 Basic redundancy system setup, 28
 Battery connectors, CPU, 17
 Battery, backup, 18
 Blocks, genius, 83
 BRM, 23
 BTM, 22
 Bumpless switching, 8
 configurable backup data size, 9
 effect on scan time, 8
 switch to backup unit time, 8
 synchronized cpus, 8
 Bus controller, genius I/O, 4, 5, 24
 Bus receiver module
 cable description, 23
 connectors, 24
 LED status indicators, 24
 Bus termination, 80
 Bus transmitter module, 22
 cable connections, 23
 connectors, 23
 faults, 82
 LED status indicators, 22
 Bus, I/O termination of, 24

C

Cable, programmer connection, 23
 Cable, programmer connection, connecting and disconnecting, 9
 Cable, terminated, 4, 5, 6, 24, 28
 Calculations, background user checksum, background window time, 69
 Checksum, program memory, 18
 COM1, 18
 COM2, 18
 Commonly used acronyms, 12
 Communications link failure, 82
 Communications module, redundancy, 7
 Communications, terminating, 76
 Components, system, 13
 Configurable backup data size, 9
 Configuration
 background window time, 68
 expansion memory board, 39
 fault actions, 67
 genius bus controller, 42
 paired gbc parameter, 42
 serial bus address, 43
 I/O system, 28
 Logicmaster 90, 28
 parameters for cpu redundancy, 27
 parameters, list of for redundancy, 10
 primary redundant cpu, 44
 bus transmitter module, 51
 configure remote communications module, 47
 genius bus controller module, 48
 genius I/O blocks, 50
 select expansion memory board, 46
 select redundancy cpu module, 45
 redundancy cpu module, 31, 40
 constant sweep mode, 35
 constant windows sweep mode, 35
 fail wait time, 36
 normal sweep mode, 34
 redund type, 34
 shared I/O reference and length, 36
 requirements, 10
 secondary redundant cpu, 52
 change redund type, 53
 with Logicmaster 90-70, 30
 Configurations, incompatible, 56
 Configuring a hot standby cpu redundancy system, 27

- Connecting Logicmaster 90, 31
- Connector, serial port, 18
- Connectors, battery, 17
- Considerations, programming, 10
- Considerations, redundancy CPU, 64
- Constant sweep mode configuration, 35
- Constant window sweep mode configuration, 35
- Contacts, timed, 70
- Control actions, fault detection, 72
- Control strategy, 5, 58
- CPU
 - features, 15
 - LEDs, 17
 - mode switch, 16
 - module for redundancy, 7
 - serial port connector, 18
 - watchdog timer, 14
- CPU 780 operating differences, 65
- CPU mode selection, 16
- CPU requirements for redundancy, 33

D

- Data integrity check, 2
- Data parameters, shared I/O, 37
- Data size, backup, 9
- Data transfer
 - %I, %AI, and synchronization, 59
 - %Q, %AQ, %R, %M, 61
- Data transfer example, backup to active unit, 61
- Data transfer, backup to active unit, 60
- Definition of terms, 11

E

- Error checking, 18
- Expansion memory, 7, 18, 38
- Expansion memory board, 39

F

- Fail wait time, 8
- Fail wait time configuration, 36
- Failsafe operation, 2
- Fault action, diagnostic fault action, 72
- Fault actions
 - conditionally fatal, 77
 - configuration of, 67
 - fatal, 77
 - fatal fault action, 72
 - non-fatal, 77
 - table of, 77
- Fault categories, 72
- Fault category actions, changing, 73
- Fault category configuration screens, 29
- Fault detection, 72
- Fault detection and control actions, 72
- Fault group actions, maskable, 78
- Fault group descriptions, maskable, 77
- Fault group descriptions, non-maskable, 79
- Fault zoom help text, redundancy error codes, 74
- Faulting RCMs, 75
- Flash memory operation, 64
- FST_EXE %S reference, 57
- FST_SCN %S reference, 57

G

- Genius blocks, configuration, 50
- Genius blocks, failure, 83
- Genius bus controller, 4, 5
 - configuration, 28
 - configuration example, 48
 - configuration of, 42
 - connectors, 26
 - description of, 24
 - faults, 82
 - LED status indicators, 25
 - redund type, 34
 - switching, 71
 - user features, 25
- Genius bus, faults, 83

- Genius bus, multiple, 26
- GeniusI/O, bus controller, 24
- GeniusI/O system, 4
- Grounding, programmer, 9
- Guidelines for run disabled mode, 66

H

- Help text, redundancy error codes, 74
- Hot standby CPU redundancy, 85
- Hot standby cpu redundancy
 - basic description of, 1
 - benefits of, 3
 - features of, 3
 - I/O systems
 - geniusI/O, 4
 - localI/O, 4
 - system configuration, 6
- Hot standby redundancy control strategy, 58

I

- I/O bus signal termination, 24
- I/O bus terminator plug, 24
- I/O system configuration, 28
- Incompatible configurations, 56

K

- Keyswitch, memory protect, 17

L

- LEDs for redundancy communications module, 7
- Link failure, communications, 82
- Links, losing, 75
- Lithium battery for memory backup, 18
- Local I/O configuration, example of, 5
- Local I/O system, 4
- Lockstep of active and standby units, 2

- Logicmaster 90 configuration, requirements, 28
- Logicmaster 90 connection, 31
- Logicmaster, serial COM port version, 18
- Logicmaster, WSI version, 18
- Losing links, 75

M

- Maskable fault group actions, 78
- Maskable fault group descriptions, 77
- Memory protect keyswitch, 17
- Memory, expansion, 18, 39
- Memory, flash, 64
- Mode selection, 16
- Mode, operating, 16
- Mode, run disabled, 65

N

- Non-maskable fault group descriptions, 79
- Normal sweep mode configuration, 34
- Normal system operation, 55

O

- On-line programming, 9
- On-line repair, 9, 80
 - central processor unit, 81
 - genius blocks, 83
 - genius bus, 83
 - genius bus controller, 82
 - power supply, 81
 - procedures, 80
 - racks, 81
 - recommendations, 80
 - redundancy communications module, 81
 - terminated parallel bus cable, 81
- Operating mode, selection of, 16
- Operating modes, valid
 - run w/ outputs enabled, 16
 - run w/ outputs disabled, 16
 - stop, 16

Operation, differences for cpu 780, 65
Operation of a cpu redundancy system, 55
OVR_PRE %S reference, 70

P

Parallel bus termination, 80
PID and Timer function blocks, 70
PLC fault table, redundancy error codes, 74
Port, standard serial COM, 18
Power-up sequence, 55
Preferred unit, 25
Primary redundant plc, configuration, 44
Primary unit, 25
Programming considerations, 10
Programming, on-line, 9

R

Rack, communications, 22
Racks
 for redundancy systems, 26
 standard Series 90, 26
 VME, 26
RCMs, faulting, 75
Redund type, configuration of, 34
Redundancy
 alternatives
 esd duplex application logic, 85
 esd duplex gmr application logic, 85
 esd triplex gmr product, 85
 hot standby application logic, 85
 hot standby product, 85
 hot standby product plus application logic, 85
 with multiple folders, handling, 30
Redundancy communications module
 connectors, 21
 description of, 19
 illustration of, 19
 LEDs, system status, 20
 board ok, 20
 local system active, 21

 local system ready, 20
 remote system active, 21
 remote system ready, 21
 pushbutton for unit selection, 21
 system status LEDs, 7

Redundancy CPU considerations, 64

Redundancy cpu considerations
 I/Ointerrupts, 64
 timed interrupts, 64
 vme integrator racks, 64

Redundancy CPU module, 7
 architecture, 14
 battery connectors, 17
 capacities, 14
 catalog number, IC697CPU780, 13
 description of, 13
 expansion memory board, 18
 features of, 15
 illustration of, 15
 installation information, 13
 location in racks, 14
 memory protect keyswitch, 17
 mode switch, 16
 serial port connector, 18
 status LEDs, 17
 watchdog timer, 14

Redundancy cpu requirements, 33

Redundancy option key, 86

Redundancy options, table of, 87

Redundancy system requirements, 28

Redundancy system setup, basic, 28

Redundant cpu module, resynchronization, 57

Reference values, shared I/O, 37

Reference, OVR_PRE, 70

References, %S, 7

References, %S, definition of, 63

Repair, on-line, 9

Requirements for configuration, 10

Resynchronization, 9

Resynchronization, redundant cpu, 57

Role switch SVCREQ, 62

Run disabled mode, 65

Run disabled mode, guidelines, 66

Run/outputs disabled mode, 16

Run/outputs enabled mode, 16

S

S (%), references, 7

Scan time, effect of bumpless switching, 8

Scan, synchronous, 59

Screens for fault category, 29

Secondary unit, 25

Sequence, power-up, 55

Serial bus address 30, 4, 6, 9, 25

Serial bus address 31, 4, 6, 9, 25

Serial COM port, standard, 18

Serial port connector, 18

Service request 27, 60

Service request 28, 60

SharedI/O, 9

- configuration, 36
- data parameters, 37
- reference values, 37

Simplex cpu, 57

Special references, 63

Start of sweep time, 57

Status LEDs, 3, 7, 17

Status references for redundancy systems, 63

STOP mode, 16

Stop to run mode transition, 68

Stop/I/O scan in a redundant system, 64

STOP/IOSCAN mode, 16

Strategy, control, 5

SVCREQ #26, 62

SVCREQ #26 example, 62

SVCREQ #27, 60

SVCREQ #28, 60

SVCREQ 27/28 example, 61

Sweep mode

- constant, 35
- constant window, 35
- normal, 34

Sweeps, active and backup, 59

Switch to backup unit time, 8

Switching control to backup unit

- from user program via SVCREQ, 61
- manual switch via pushbutton, 61
- on a failure, 61

switching, bumpless, 8

Synchronization, 59

- restrictions for applications, 88

Synchronized cpus, 8

Synchronous scan, 59

System components for redundancy, 13

System operation, normal, 55

System setup, basic, 28

T

Terminated parallel cable, 80

Terminated I/O cable, 4, 5, 6, 24, 81

Terminating communications, 76

Terminating I/O bus, 24

Terminator plug, 24

Terms, definitions of, 11

Text, help, 74

Time to switch to backup unit, 8

Timed contacts, 70

Timer and PID function blocks, 70

Transition, stop to run mode, 68

W

Wait time, fail, 8

Window time, background, 68